

Assembly Instructions

Caution : You must read this before you proceed

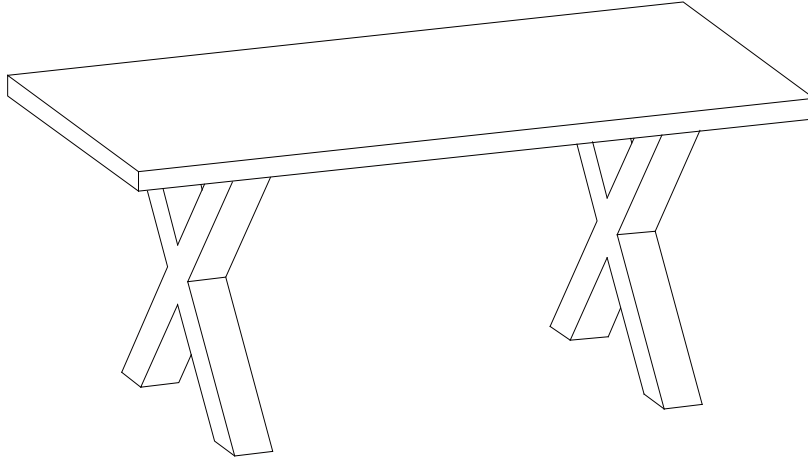



Table

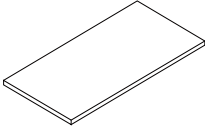
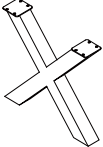

Part List

Label	Picture	Description	QTY
A		Table Top	1
B		Table Legs	2

Hardware

Label	Picture	Description	QTY
①		Screw (M8 *25MM)	17
②		Spring washer	17
③		Flat Washer	17
④		Allen key	1

Assembly Preparation

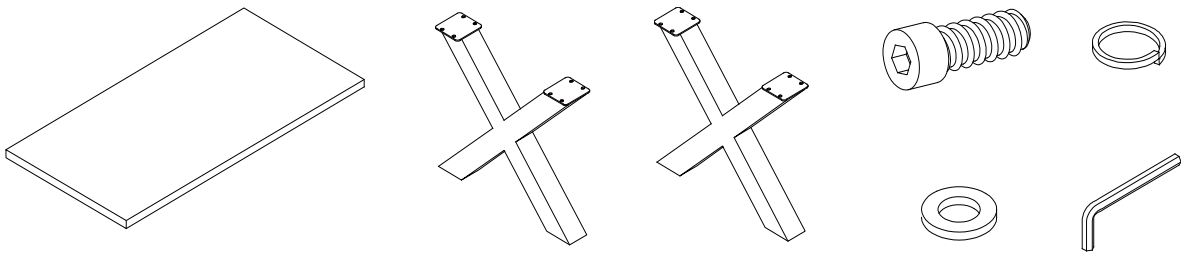

Before Beginning Assembly:

*Before beginning assembly of product, make sure all parts are present. Compare parts with package contents list. If any parts are missing or damaged, do not attempt to assemble the product.



- Read instructions, cover to cover-



- Have 2 adults on hand for assembly-



- Do not assemble on flooring or carpet-



- Assemble on a clean non-marring surface (packing foam)-



- Save all packaging until finished-

Assembly Steps

OVERVIEW

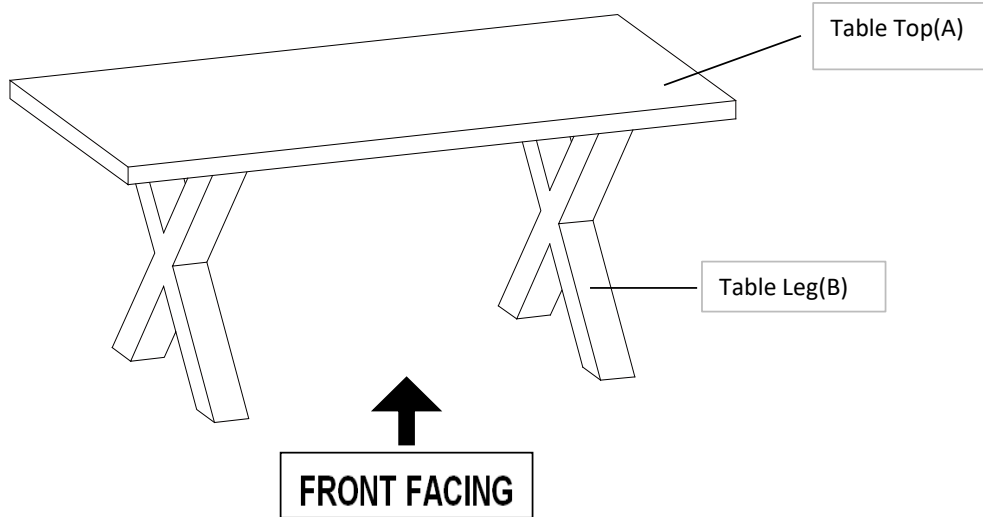

This Table has multiple parts and may require up to 30 minutes to assemble. To give you an overview of the Table parts, the above picture is to help you put the various Table parts into perspective. Please read through the instructions below to familiarise yourself with the parts and steps before assembly.

Step 1

Hardware Used

①: M8 Screw



②: Spring Washer



③: Flat Washer



④: Allen key

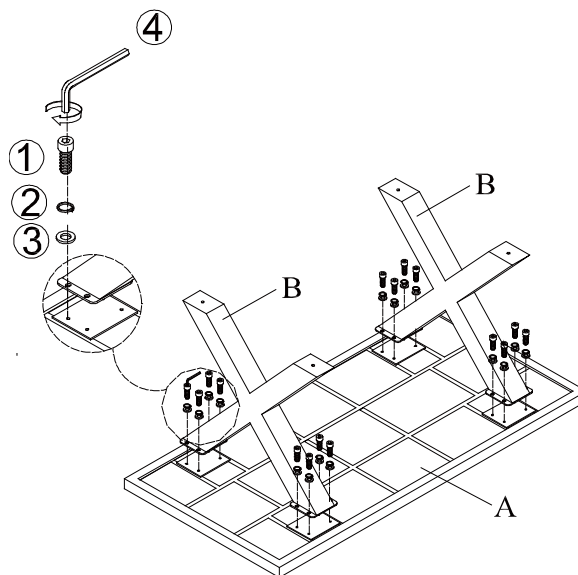

Position the bottom of the Table top(A) as shown.

And then insert the Legs(B) into the mounting position of Table Top(A).

Attach the Legs(B) by using M8 Screw(1) + Spring Washer(2)+ Flat Washer (3), onto metal plate of Legs(B), with Allen Key(4).

Do not over tighten Screws(1) while assembling the Legs(B) in order to adjust the Legs(B) as needed while assembling and make sure you follow the steps fully.

Step 2

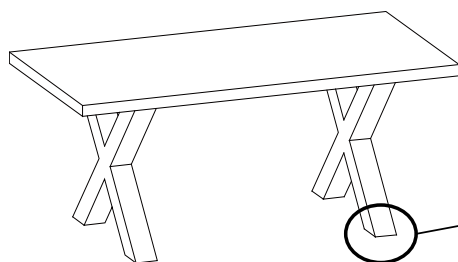

Adjust height
for balance

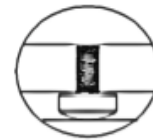

Adjust low
for balance

Adjust Pre-installed
Levellers
height for balance

Stand the table up.

If the Table wobbles, adjust the Pre-installed Levellers at the bottom of the Legs until the Table is level.

This Table can only be used on a flat, level surface.



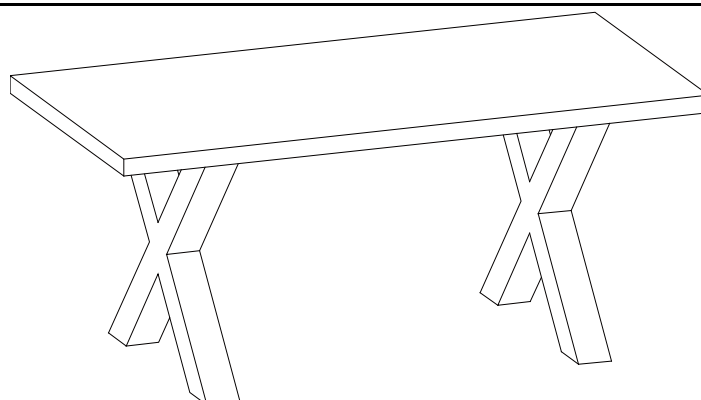





Step 3



Make sure all parts are connected and securely locked into position.

Your Table is ready for use.

Care & Maintenance

-  ● Do not put hot items directly on furniture surface
 -  ● Do not clean furniture with harsh cleansers or polish.
 -  ● To obtain the longest lifespan of your outdoor products, minimizing exposure to direct sunlight is recommended.
 -  ● Children should not climb or jump on the furniture.
 -  ● Do not write on furniture without a padded barrier to protect the surface.
 -  ● To obtain the longest lifespan of your outdoor products, avoid extended and lengthy exposure to rain, snow, and direct sunshine. Whenever possible cover the product and /or place under patio or awnings.
 -  ● Not for commercial use. For residential use only .
 -  ● Stains may be removed with mild soap solution and damp cloth.
-
-  ● Dust and pick-up spills using a clean, non-colored, lint-free cloth .

Questions & Answers about Proposition 65

• What is Proposition 65?

Proposition 65 requires businesses to provide warnings to Californians about significant exposures to chemicals that cause cancer, birth defects or other reproductive harm. These chemicals can be in the products that Californians purchase, in their homes or workplaces, or that are released into the environment. By requiring that this information be provided, Proposition 65 enables Californians to make informed decisions about their exposures to these chemicals.

Proposition 65 also prohibits California businesses from knowingly discharging significant amounts of listed chemicals into sources of drinking water.

Proposition 65 requires California to publish a list of chemicals known to cause cancer, birth defects or other reproductive harm. This list, which must be updated at least once a year, has grown to include approximately 900 chemicals since it was first published in 1987.

• What types of chemicals are on the Proposition 65 list?

The list contains a wide range of naturally occurring and synthetic chemicals that include additives or ingredients in pesticides, common household products, food, drugs, dyes, or solvents. Listed chemicals may also be used in manufacturing and construction, or they may be byproducts of chemical processes, such as motor vehicle exhaust.

• What does a warning mean?

If a warning is placed on a product label or posted or distributed at a workplace, a business, or in rental housing, the business issuing the warning is aware or believes that it is exposing individuals to one or more listed chemicals.

By law, a warning must be given for listed chemicals unless the exposure is low enough to pose no significant risk of cancer or is significantly below levels observed to cause birth defects or other reproductive harm.

• Where can I get more information on Proposition 65?

If you have specific questions on the administration or implementation of Proposition 65, you can contact OEHHA's Proposition 65 program at P65.Questions@oehha.ca.gov, or by phone at (916) 445-6900.