













ASSEMBLY INSTRUCTION

BOX OF BED BED

ITEM	DRAWING	DESCRIPTION	QTY
A		HEAD BOARD	1
B		HEAD BOARD LEG (L)	1
C		HEAD BOARD LEG (R)	1
D		FOOT BOARD	1
E		SIDE RAIL	2
F		SIDE RAIL	2
G		SLAT	4
H		SUPPORT LEG	8
I		SIDE RAIL SUPPORT LEG	2

BOX OF BED HARDWARE LIST

ITEM	DRAWING	DESCRIPTION	QTY
1		JCBC SCREW M8x20mm	8
2		JCBC SCREW M8x25mm	8
3		JCBC SCREW M8x35mm	6
4		JCBC SCREW M6x35mm	8
5		SPRING WASHER	14
6		FLAT WASHER	14
7		SCREW M4x32mm	8
8		L-KEY M4x65mm	1
9		L-KEY M5x65mm	1

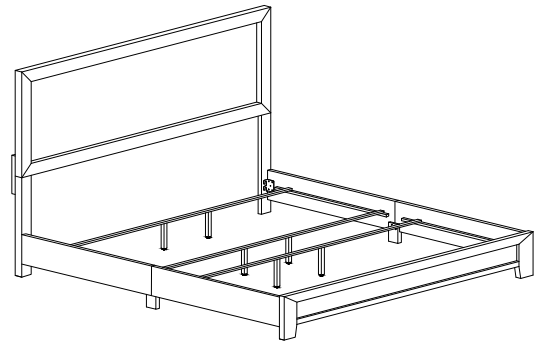

COMPLETED BED ASSEMBLY

STEP 1

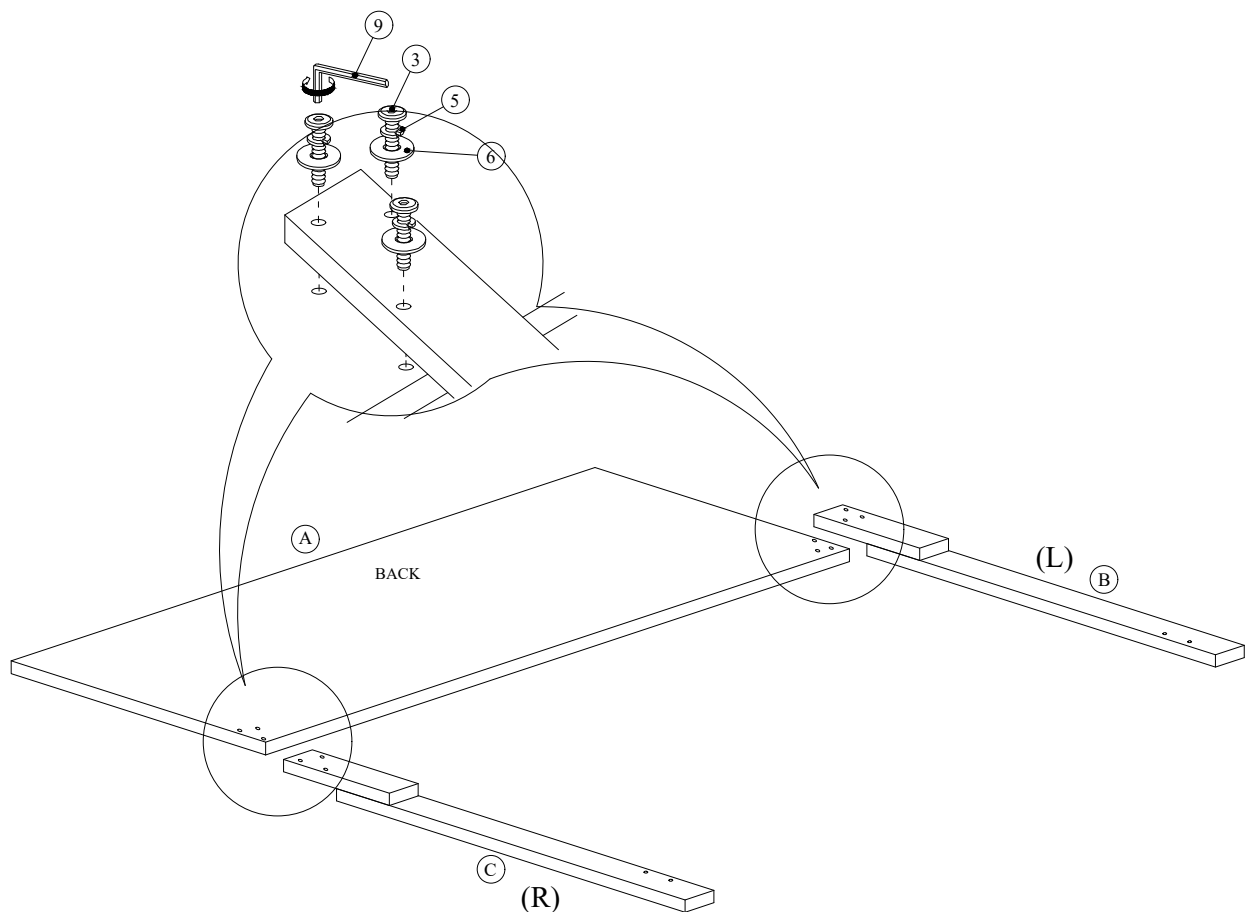

THE HARDWARE IS LOCATED IN THE PACKING ITEMS

PAGE 01 OF 02

NOTE : MUST TIGHT SCREWS PERIODICALL. WITH USE SCREWS MAY BECOME LOOSE.
CHECK TIGHTNESS OF ALL SCREWS EVERY 6-8 WEEKS.

ASSEMBLY INSTRUCTION

STEP 2

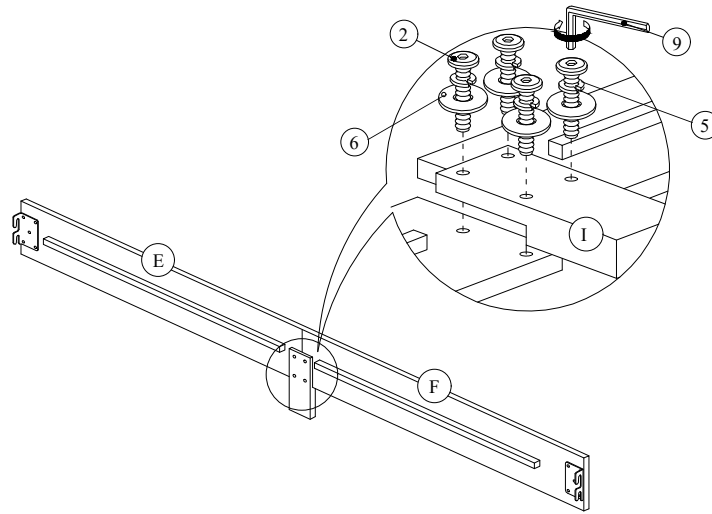

STEP 3

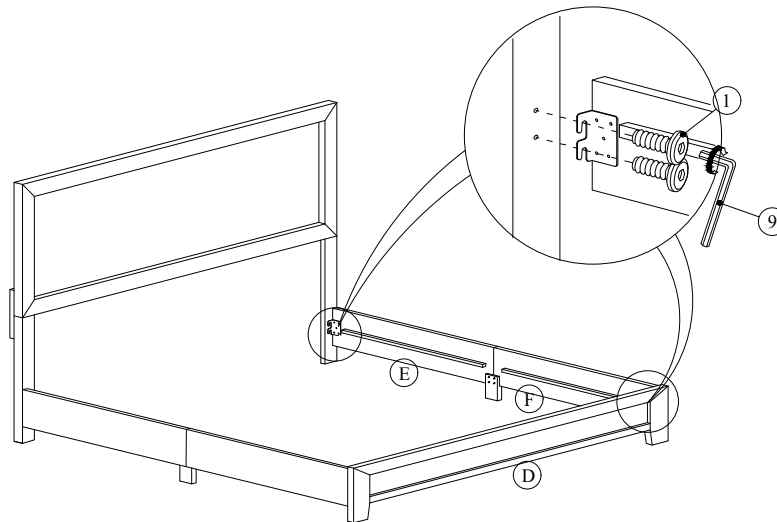

STEP 4

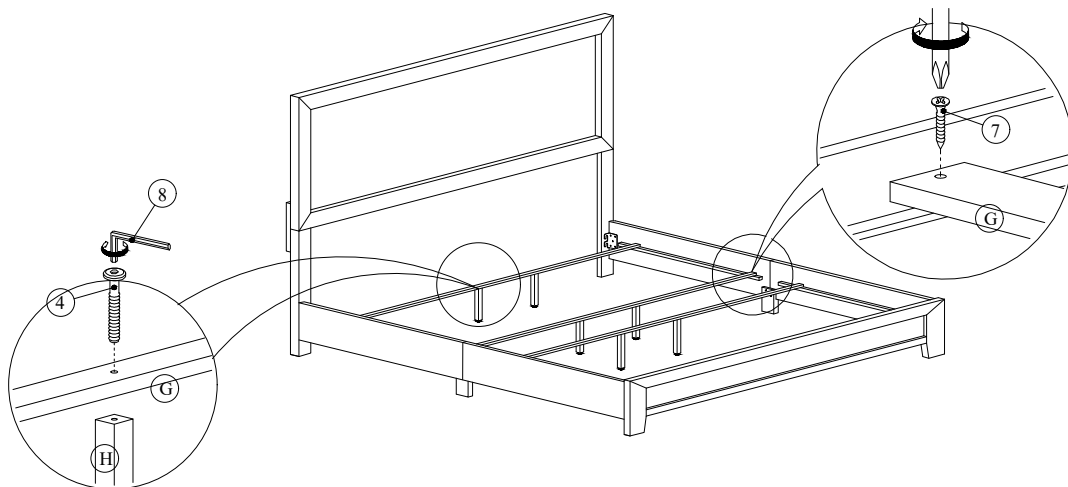

THE HARDWARE IS LOCATED IN THE PACKING ITEMS

PAGE 02 OF 02

NOTE : MUST TIGHT SCREWS PERIODICALL. WITH USE SCREWS MAY BECOME LOOSE.
CHECK TIGHNESS OF ALL SCREWS EVERY 6-8 WEEKS.