

INSTALLATION MANUAL

PIVOT MIRROR

ABOUT US

Thank you for shopping with us! We hope that our products have added a touch of brightness to your life. If you need any assistance, please don't hesitate to reach out. Our dedicated team is available 24/7 to ensure your satisfaction.

ACCESSORIES LIST

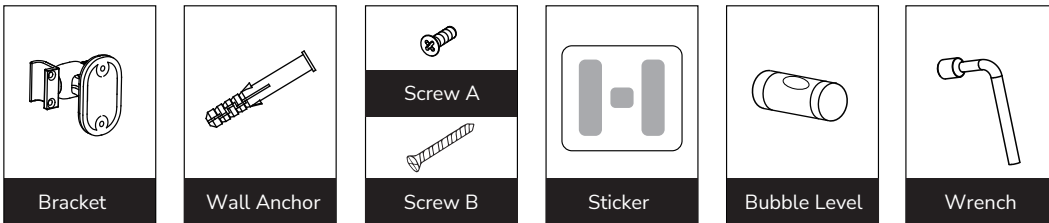

TOOLS REQUIRED

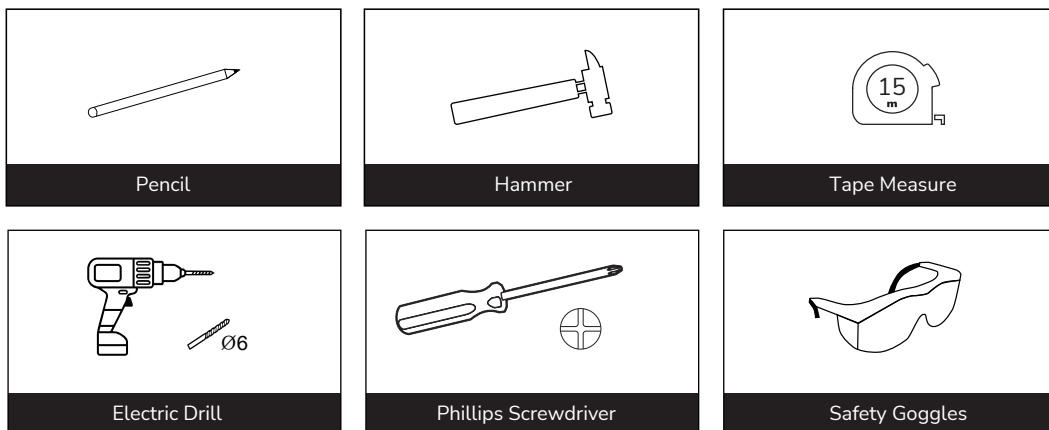

INSTRUCTIONS

1. Decide whether you want to hang the mirror vertically or horizontally. Mount the brackets to the mirror accordingly with screw A.

• Option 1: Vertical Hanging

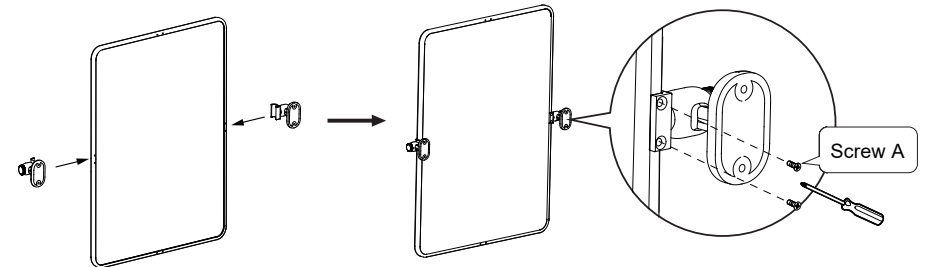

• Option 2: Horizontal Hanging

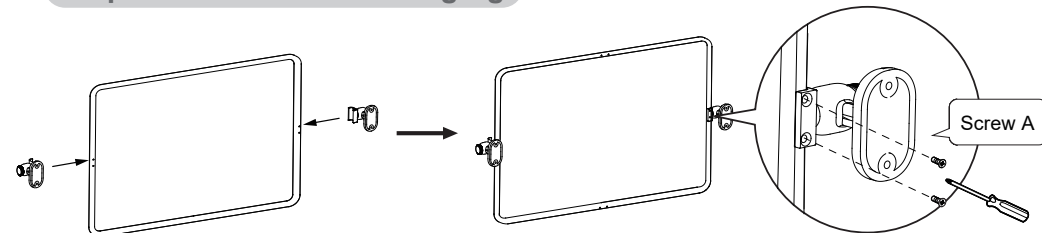

Note: Keep the product installed with a bracket in the vertical direction

2. Place the mirror on the positioning paper provided, and align the left bracket with the outline on the positioning paper (①). Outline the other bracket on the other side and mark spots for drilling (②).

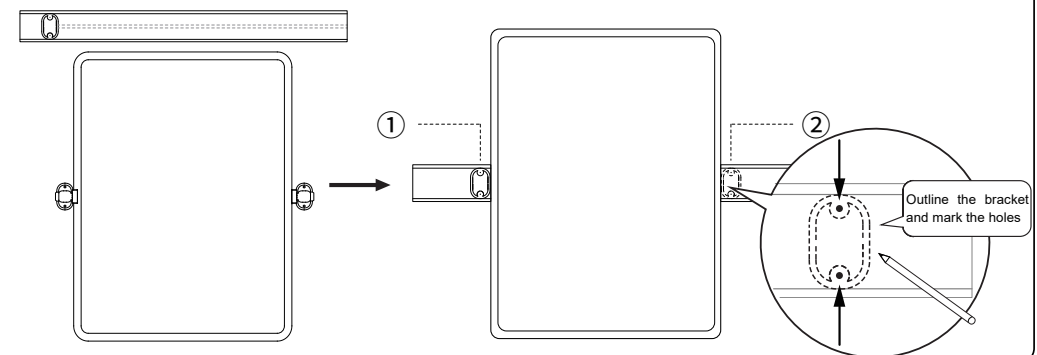

3. Apply stickers ① ② to the back of the positioning paper. Find the midpoint between two brackets on the front and apply one sticker. Stick the bubble level and adjust it to be perfectly centered.

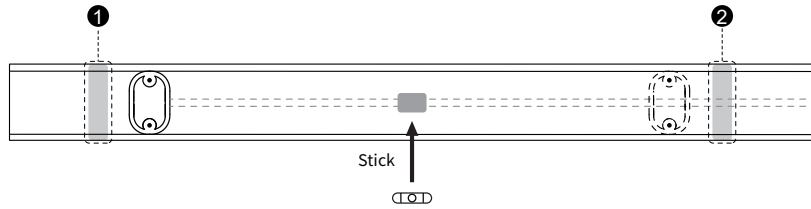

4. Place the mirror against the wall, confirm where it will locate and mark the placement, with enough spacing at the top and bottom (①). Put the mirror down, place the positioning paper on the wall and make sure that it's perfectly horizontal according to the bubble level (②). Then stick the paper to the wall on both ends.

①

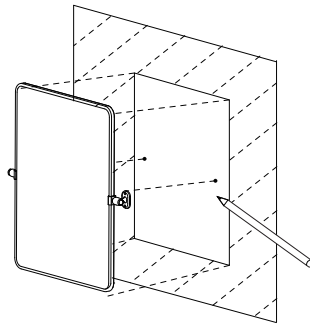

②

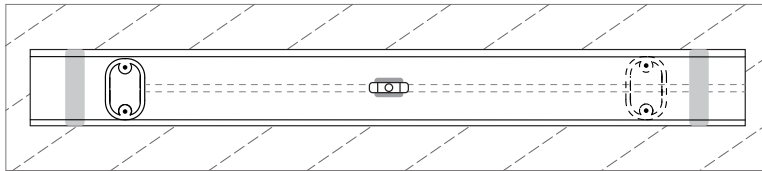

5. Drill holes at the spots indicated by the positioning paper (①). Remove the positioning paper and insert wall anchors with a hammer (②).

①

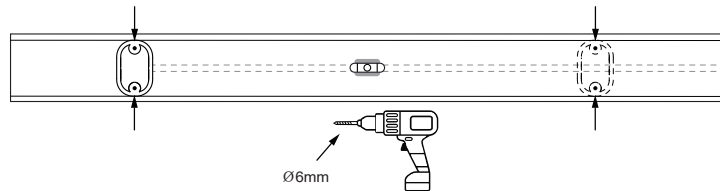

3

②

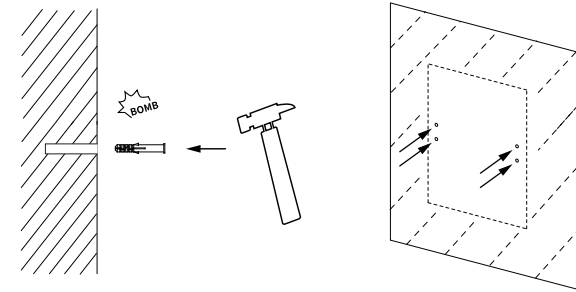

6. Lift up the mirror to where the drill holes are and fix the brackets to the wall with screw B securely. Once the installation is completed, adjust the mirror to your desired angle.

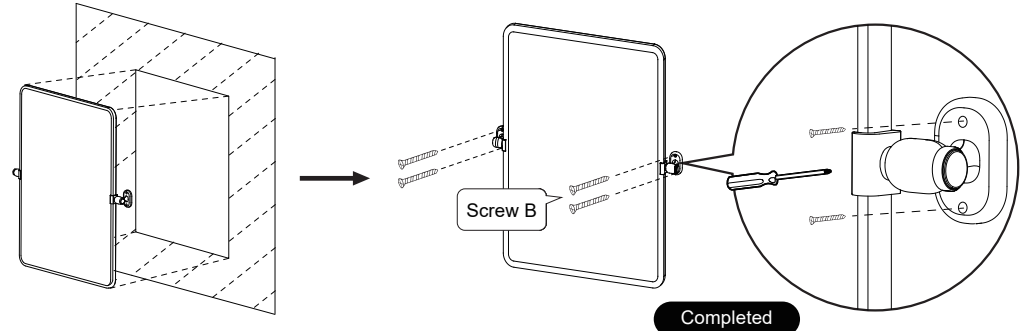

HOW TO ADJUST BARCKET

Unscrew the cover of the bracket (①), use a wrench to tighten or loosen it (②), and screw the cover back (③) after completion.

①

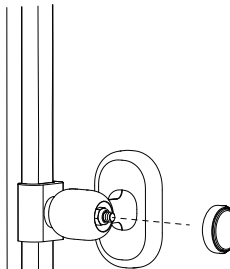

②

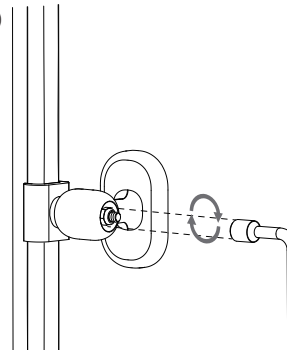

③

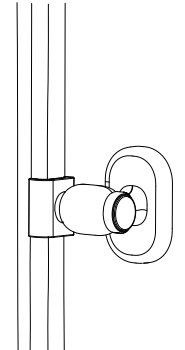

4