

ASSEMBLY INSTRUCTIONS

TWIN



+ Do Not Use Power Tools



+ Suggested Adults

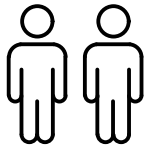

NOTE:

- 1 Read instructions cover to cover.
- 2 Save all packaging until assembly is completed.

1 IMPORTANT SAFETY INFORMATION

Do not assemble the product if any of the following parts arrived damaged:

1. Headboard Panel
2. Footboard Panel
3. Wing Left
4. Side Rail Left
5. Wing Right
6. Side Rail Right
7. Side Rail LVL Front
8. Side Rail LVL Back
9. Slat(13pcs)
10. Leg

2 IMPORTANT ASSEMBLY INFORMATION

Assembly Step Ensure the side rail bracket is fully hooked onto bolt loosely threaded with both washers on the **OUTSIDE** of the bracket first, then proceed to fully tightening all 4 corners.

+ Parts Included

- ① Headboard Panel (1 pc) ② Footboard Panel (1 pc)



- ③ Wing Left (1 pc)



- ④ Side Rail Left (1 pc)



- ⑤ Wing Right (1 pc)

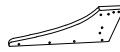

- ⑥ Side Rail Right (1 pc)

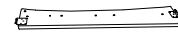

- ⑦ Side Rail LVL Front (2 pcs)

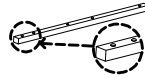

- ⑧ Side Rail LVL Back (2 pcs)



- ⑨ Slat(13pcs) (1 pc)



- ⑩ Leg (4 pcs)



+ Hardware Included

- A. Allen Key M4 (1 pc) B. Allen Key M5 (1 pc) C. Spanner 12.8mm (1 pc)

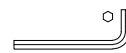

- D. Side Rail Connect (2 pcs)



- E. Bracket 4002 (2 pcs)



- F. Hex Nut $\frac{5}{16}$ (2 pcs)



- G. JCBB Bolt M8 x 16mm (8 pcs)



- H. JCBB Bolt M6 x 25mm (8 pcs)



- I. JCBB Bolt M6 x 50mm (26 pcs)



- J. Spring Washer M8 (12 pcs)



- K. Flat Washer M6 (8 pcs)



- L. CBS Screw M4 x 25mm (8 pcs)



- M. CBS Screw M4 x 32mm (6 pcs)



ASSEMBLY INSTRUCTIONS

TWIN

1

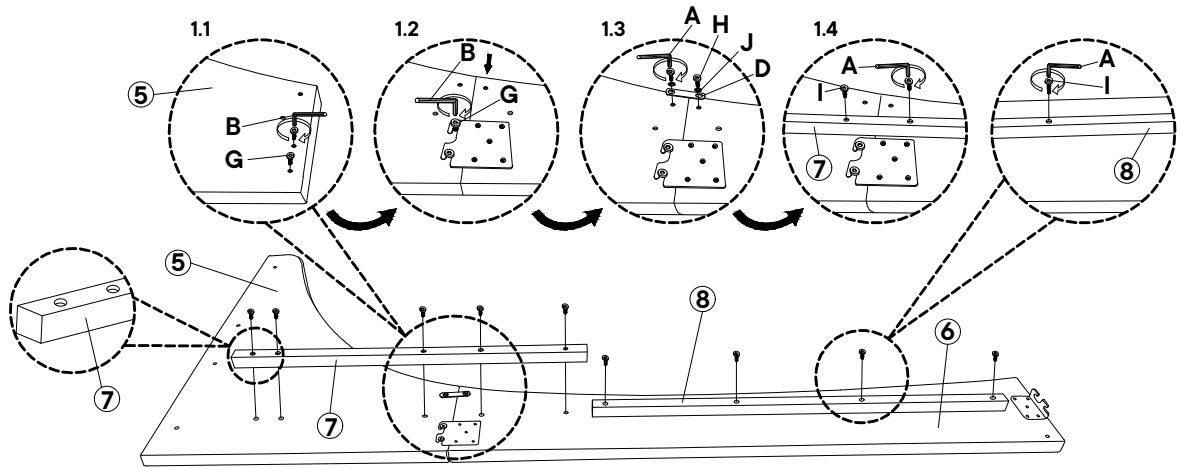

2

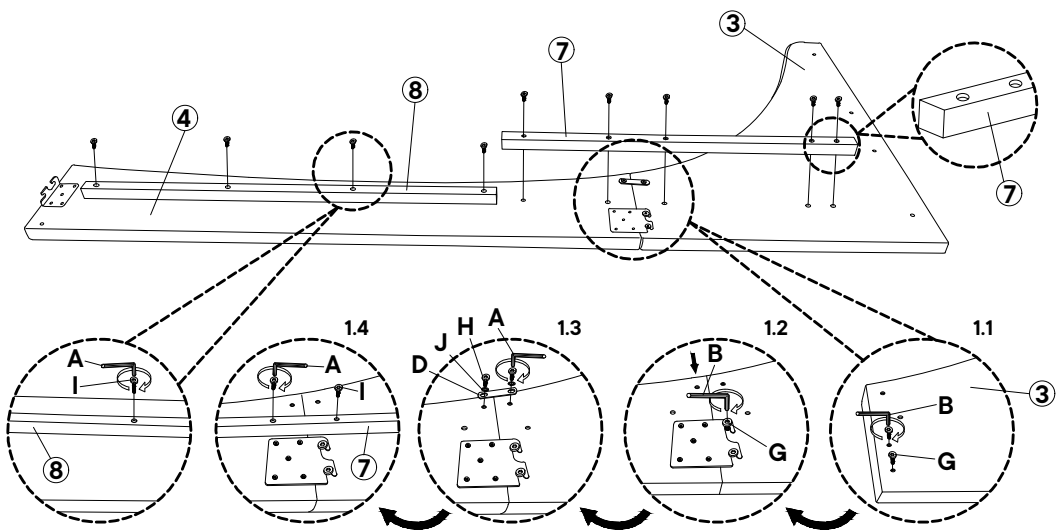

ASSEMBLY INSTRUCTIONS

TWIN

