

# Square Arm Sleeper Assembly Manual

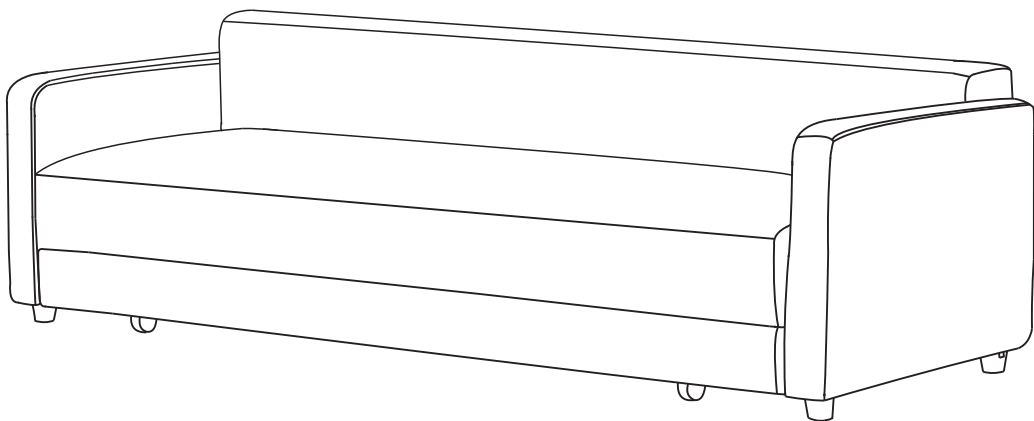





# Product Information

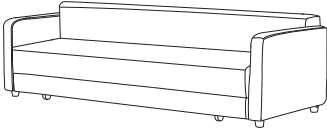
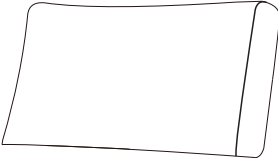

Overall Sofa Dimensions: 88.2" x 40.9/54.3" x 31.5" (224cm x 104/138cm x 80cm)

Overall Sofa Weight: 196.2 lbs (89kg)

## Components

<p>Component A Part: Sofa Bed Base Qty 1</p> 	<p>Component B Part: Back Cushion Qty 2</p> 		
<p>Component E Part: Rear Plastic Leg Qty 2</p>	<p>Component F Part: Front Plastic Leg Qty 2</p>	<p>Component G Part: Wheel Qty 2</p>	<p>Component I Part: Support Leg Qty 4</p>
			

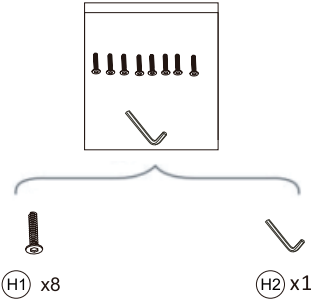
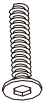
## Hardware

<p>Component H Part: Hardware Plastic Bag Qty 1</p>	<p>Hardware H1: Bolt (M6X20mm) Qty 8</p>	<p>Hardware H2: Allen Wrench (M5) Qty 1</p>
		

# Assembly Steps

Step 1: Remove the Hardware Plastic Bag (H) from the bottom of the Sofa Bed Base (A).

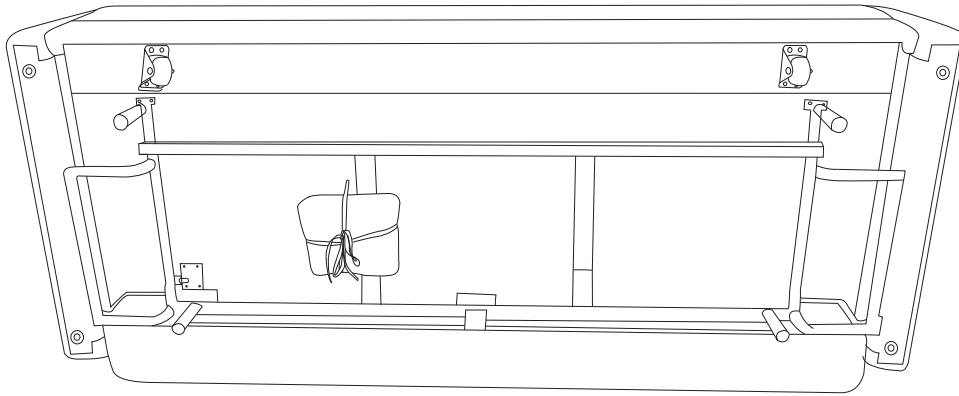
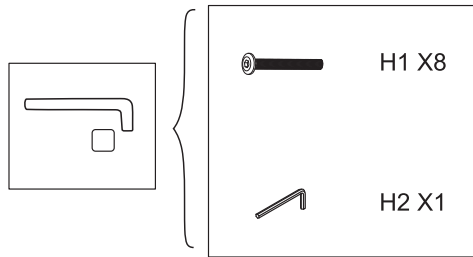

Step 2: Screw the Front Plastic Legs (F), Rear Plastic Legs (E) and Support Legs (I) to the bottom of the Sofa Bed Base (A) by hand.

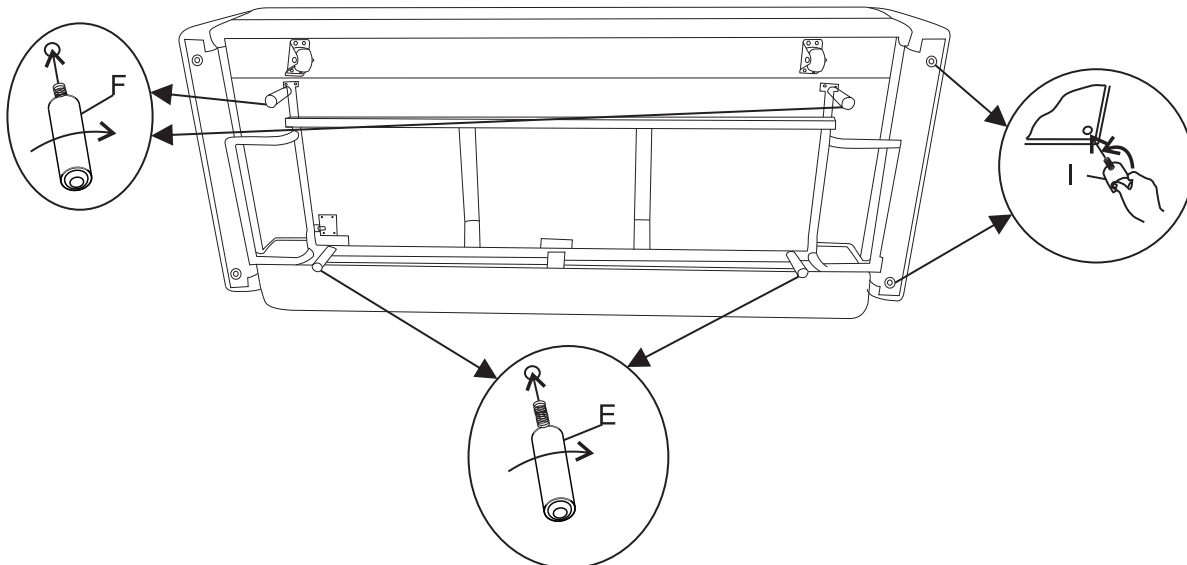

# Assembly Steps

Step 3: Unpack the Hardware Plastic Bag (H) and then use the Allen Wrench (H2) to install the Wheels(G) with Bolts (H1) to the bottom of the sofa bed base (A).

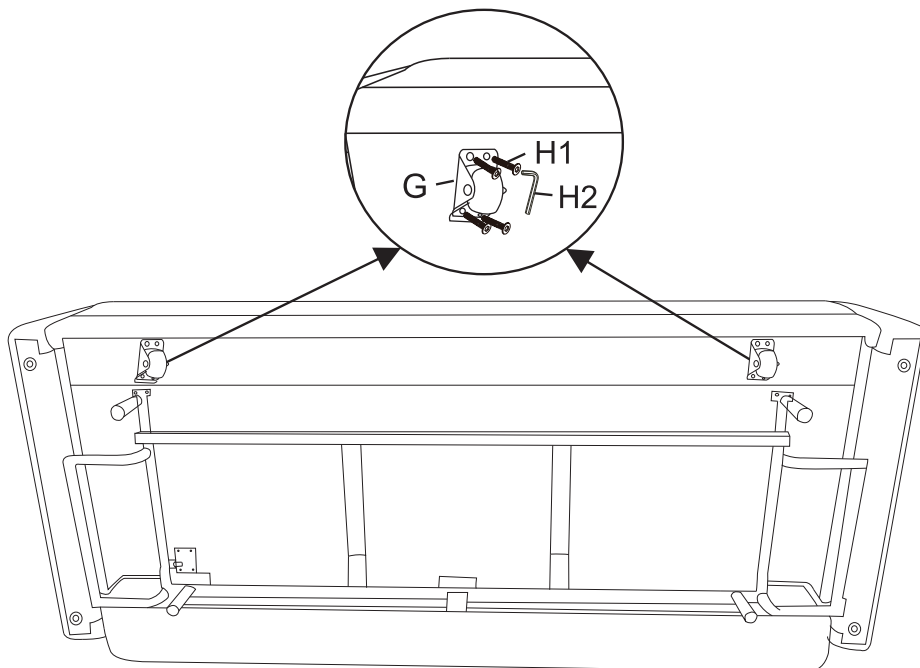

## Assembly Steps

Step 4: To change the sofa to bed, just bring down the back cushion and pull out the seat as shown.

