

ASSEMBLY INSTRUCTIONS

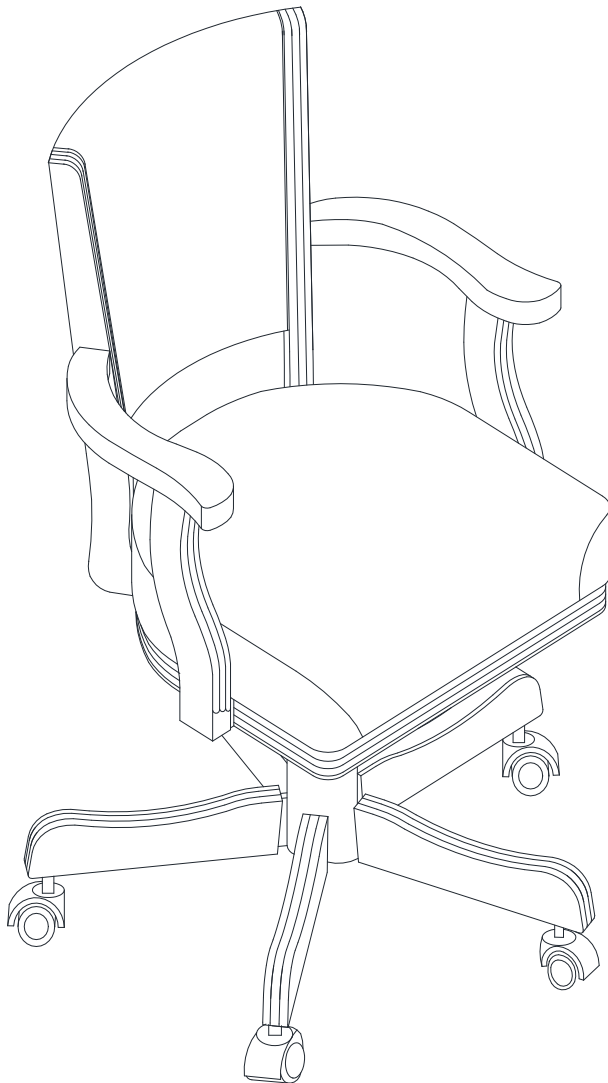

TOOLS REQUIRED

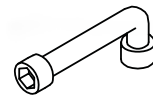

Wrench
(Included)

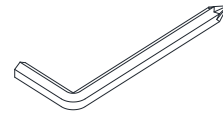

Allen Wrench
(Included)



**2 - People
Recommended**

ASSEMBLY RATING



EASY —————> DIFFICULT

The Assembly Rating is a 5-point system showing the level of effort needed to assemble a specific product.

PRE ASSEMBLY INTRODUCTION

We understand building ready-to-assemble furniture can be a challenging experience for some. To help avoid confusion, we have provided some helpful tips that may speed up the process.

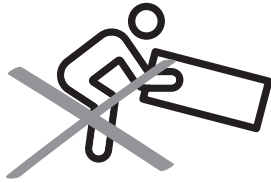

Teamwork

ALWAYS have at least two people to help with transporting and assembling the product to avoid potential injury and/or damage.

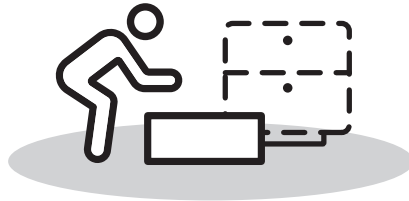
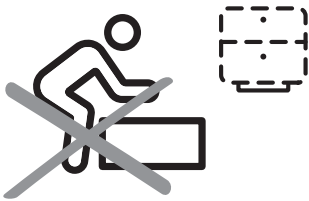

Suitable Location

Assembling near the area of the intended location is highly recommended.



Sufficient Space

Make sure you have enough space to move around during the assembly.

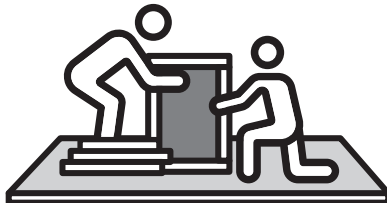

Avoid Scratches

Use cardboard, blankets or a carpeted area while assembling furniture to prevent to prevent scratches and damages.

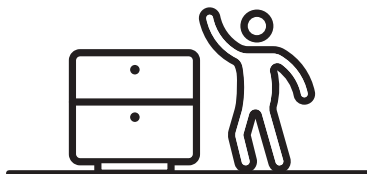
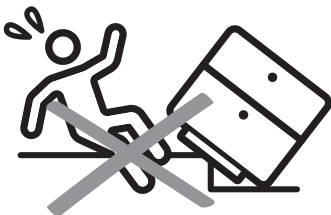

Flat Surface

Make sure the furniture rests on a flat and level surface with each leg evenly touching the floor.

ASSEMBLY AND CARE ADVICE



FAILURE TO FOLLOW THE GUIDELINES BELOW MAY RESULT IN INJURY AND/OR PROPERTY DAMAGE.



Position each part correctly and insert screws or bolts into their respective holes.



Use the appropriate hand tools or power tools for assembly. Select steps, such as tightening screws and/or bolts, may require hand tools to avoid causing damage during assembly.

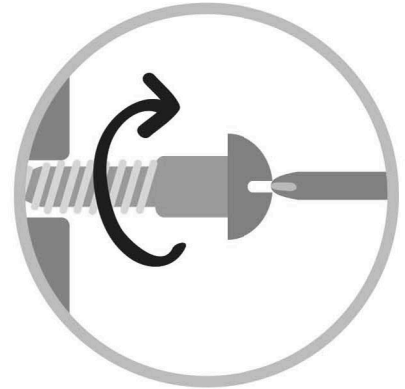

Turn clockwise to tighten and only tighten when step is completed or when instructed to do so.



Save the instructions and store any supplied tools for later maintenance.



After two weeks, check and tighten any loose hardware and repeat again every six months thereafter.

IT IS THE USER'S RESPONSIBILITY TO MAINTAIN THE FURNITURE. THE HARDWARE MAY LOOSEN OVER TIME AND MAY CAUSE THE FURNITURE TO BE WOBBLY AND UNABLE TO SUPPORT ITS INTENDED WEIGHT CAPACITY. THIS MAY LEAD TO COLLAPSE AND MAY CAUSE SERIOUS INJURY.

ARM CHAIR



- Please keep instructions for future reference.
- Check the quantity and irregularity of parts and hardware before you start.

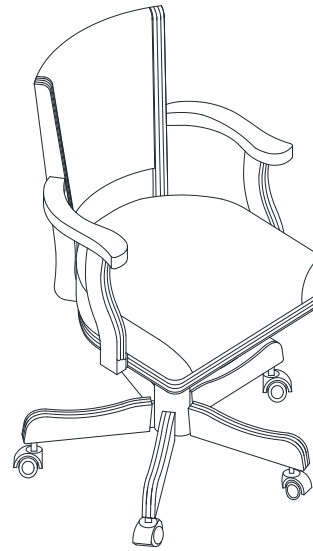

PARTS

#1 1pc

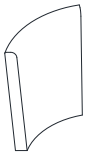

Back Cushion

#2 1pc

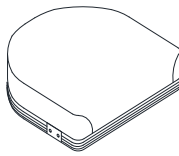

Seat

#3 1pc



Right Back Support Bar

#4 1pc

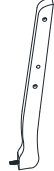

Left Back Support Bar

#5 1pc



Right Chair Arm

#6 1pc



Left Chair Arm

#7 1pc

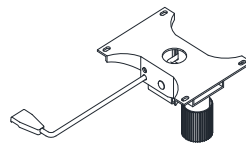

Seat Plate

#8 1pc



Gas Lift Cylinder

#9 1pc

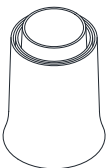

Cylinder Cover

#10 1pc

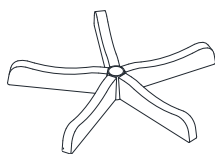

5-Star Base

ARM CHAIR



- Please keep instructions for future reference.
- Check the quantity and irregularity of parts and hardware before you start.

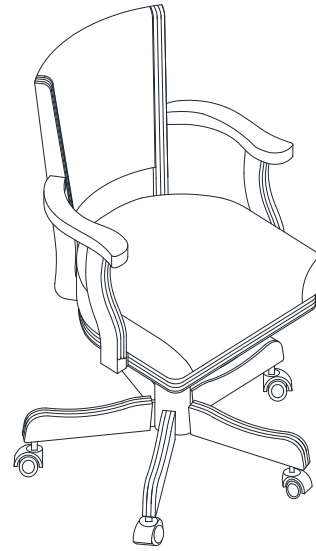

HARDWARE

#A 4pcs

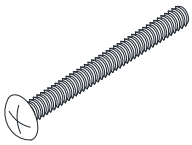

Bolt \varnothing 1/4" x 40mm

#B 4pcs

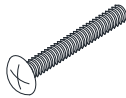

Bolt \varnothing 1/4" x 25mm

#C 4pcs



Flat Washer \varnothing 1/4" x 12mm

#D 12pcs



Flat Washer \varnothing 5/16" x 16mm

#E 8pcs

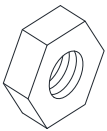

Hex Nut

#F 4pcs



Wood Plugs

#G 5pcs



Caster

#H 1pc

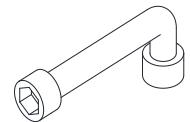

Allen Wrench

#I 1pc

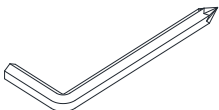

Allen Wrench

ASSEMBLY INSTRUCTIONS

1

- Part #3 x1pc
- Part #4 x1pc
- Part #5 x1pc
- Part #6 x1pc
- Hardware #D x2pcs
- Hardware #E x2pcs

1. Insert the threaded end of the right chair arm (#5) into the right back support bar (#3).

2. Apply a washer (#D) then a hex nut (#E) onto the threaded end. Secure using the Allen wrench (#H).

3. Repeat the process with the left chair arm (#6) and left back support bar (#4).

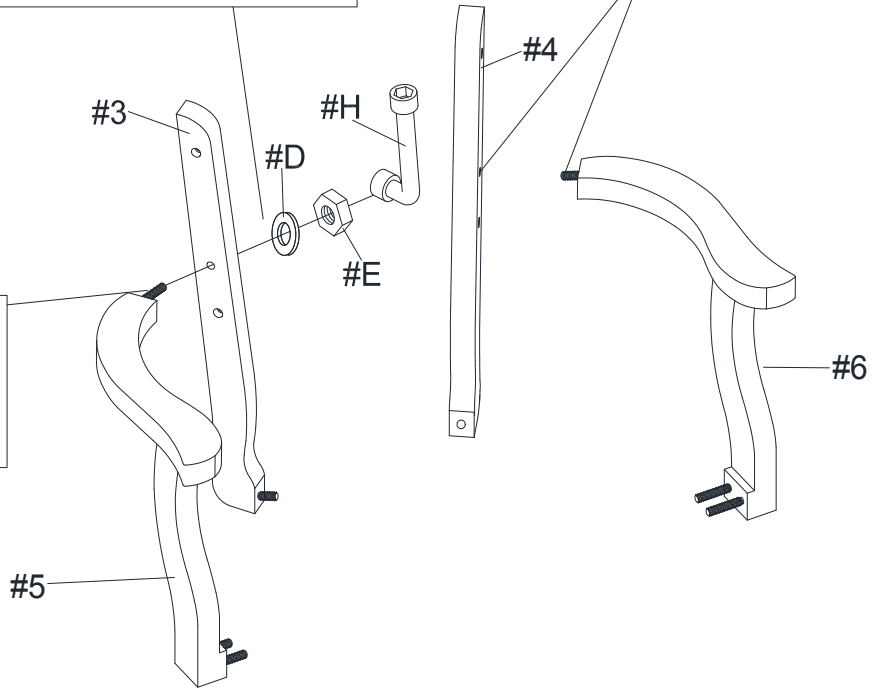

2

- Part #2 x1pc
- Hardware #D x6pcs
- Hardware #E x6pcs

1. Insert the threaded ends along the bottom of the right back support bar (#3) and the right chair arm (#5) into the seat (#2).

3. Repeat the process with the left chair arm (#6) and left back support bar (#4).

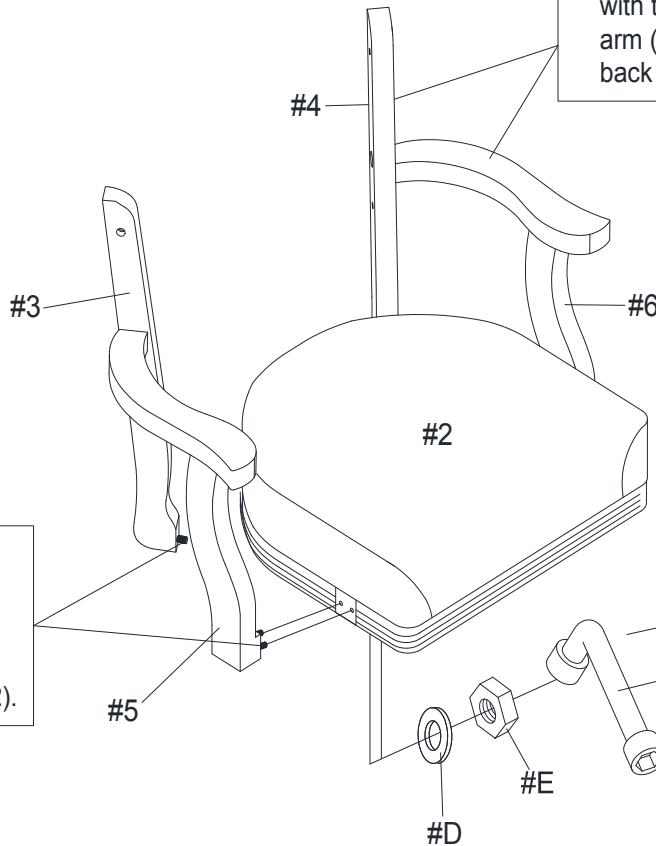

2. Apply a washer (#D) then a hex nut (#E) onto the threaded ends. Secure using the Allen wrench (#H).

ASSEMBLY INSTRUCTIONS

3

- Part (#1) x1pc
- Hardware (#A) x4pcs
- Hardware (#C) x4pcs
- Hardware (#F) x4pcs

1. Slide the back cushion (#1) between the back supports.

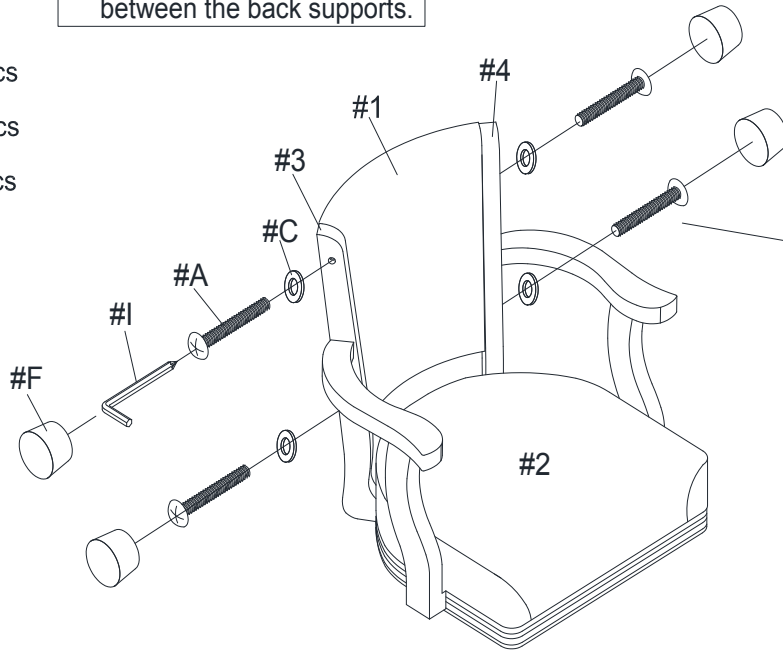

2. Prepare 4 bolts by inserting a washer (#C) onto the bolts (#A). Then insert the bolt assemblies into the holes along the sides of the back supports. Secure using a screwdriver.

3. Apply a wood plug (#F) into each hole.

4

- Part (#7) x1pc
- Part (#8) x1pc
- Part (#9) x1pc
- Part (#10) x1pc
- Hardware (#B) x4pcs
- Hardware (#D) x4pcs
- Hardware (#G) x5pcs

6. Prepare 4 bolts by inserting a washer (#D) onto the bolts (#B), then insert the bolts into the seat plate (#7). Secure using the Allen wrench (#I).

5. Place the seat (#2) onto the seat plate (#7).

4. Apply the seat plate (#7) onto the cylinder cover (#9).

3. Apply the cylinder cover (#9) onto the gas lift cylinder (#8).

2. Apply the gas lift cylinder (#8) onto the 5-star base (#10).

1. Insert a caster (#G) into each end of the 5-star base (#10).

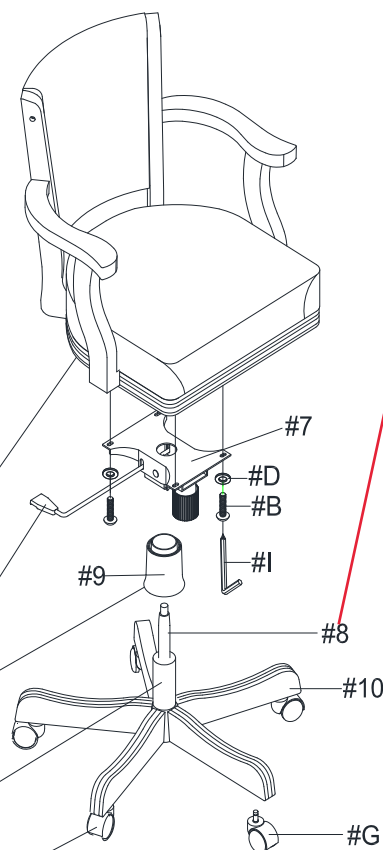

Remove cap on the tip of gas cylinder (#8) before assembly.

ASSEMBLY COMPLETED



Please ensure the furniture rests on an even and flat surface. If the product wobbles or feels loose, double-check all bolts and/or screws are properly tightened and secured.

Keep this handy!

Please retain this instruction manual and any order-related information for future reference.

Lift, don't drag!

To avoid damage to product please always LIFT the product when transporting or adjusting the placement.