

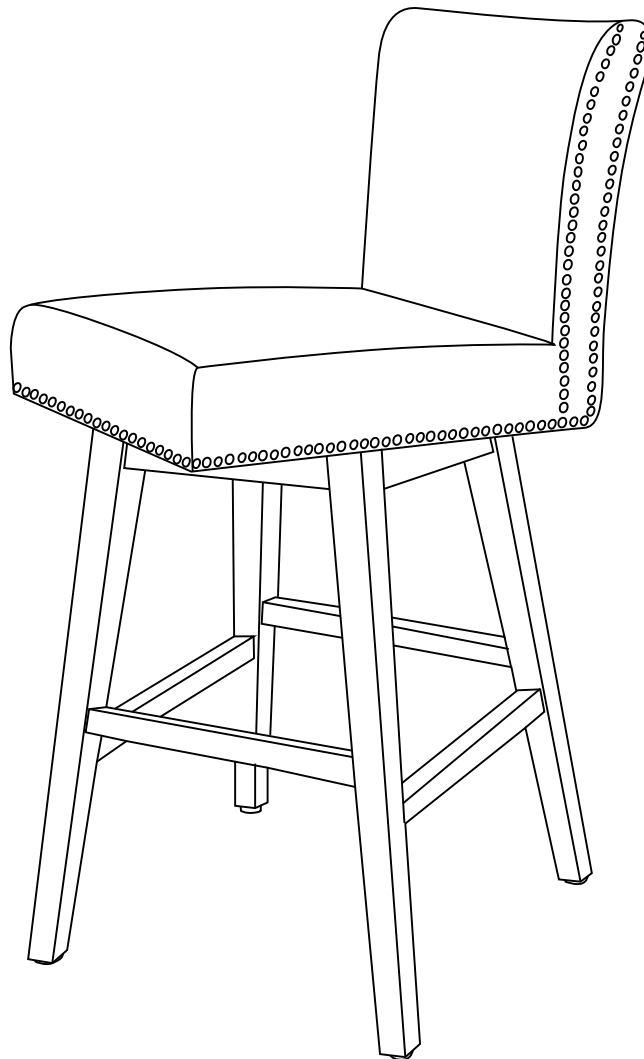

# Assembly Manual

## Counter & Bar Height Swivel Stool

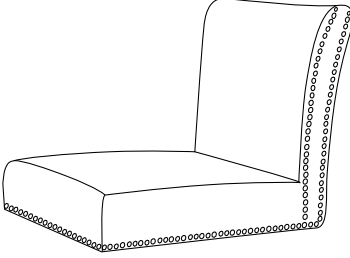
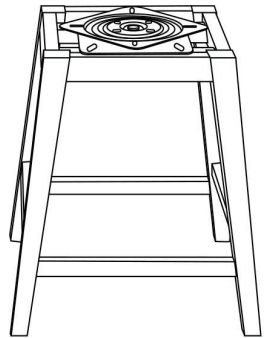

**▲ CAUTION**

THIS ASSEMBLY MANUAL CONTAINS IMPORTANT SAFETY INFORMATION.  
PLEASE READ AND KEEP FOR FUTURE REFERENCE.

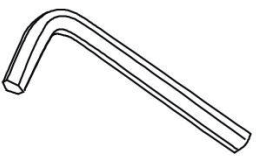
PART	DRAWING	DESCRIPTION	QTY
A		STOOL SEAT BUCKET	1
B		SWIVEL STOOL BASE	1
H1		LONG BOLT	4
H2		ALLEN KEY	1

## ASSEMBLY INSTRUCTIONS

- 1 Flip over the stool seat bucket.
- 2 Slightly rotate the top swivel plate approximately 45 degrees.

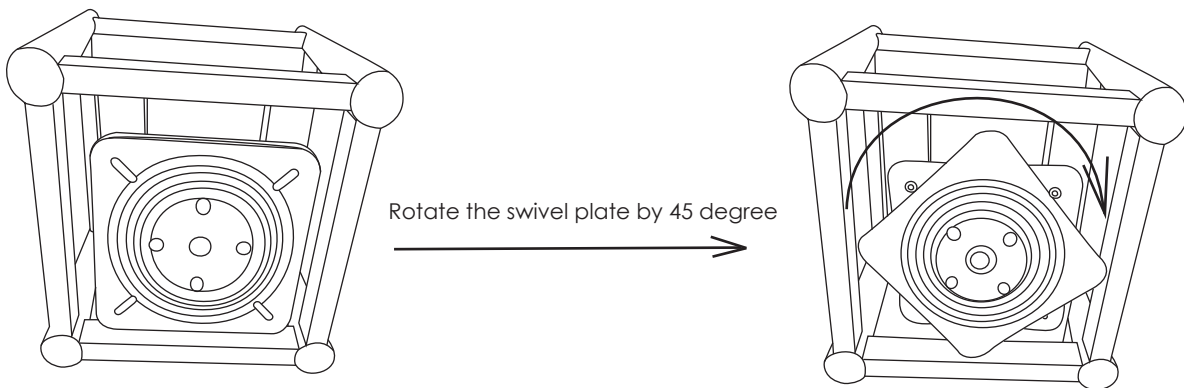

- 3 Place the swivel stool base on the stool seat bucket bottom and insert Long Bolts (H1) into each corner and tighten.

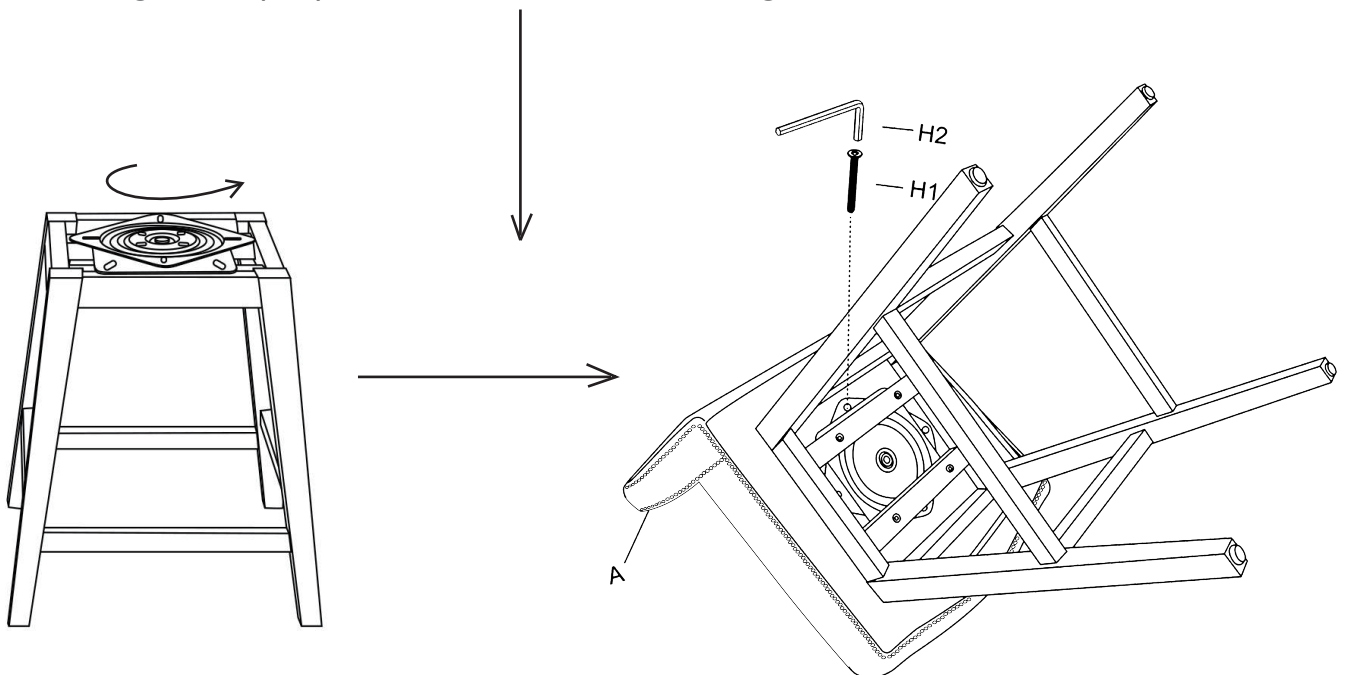

**4** Assembly complete. Enjoy.

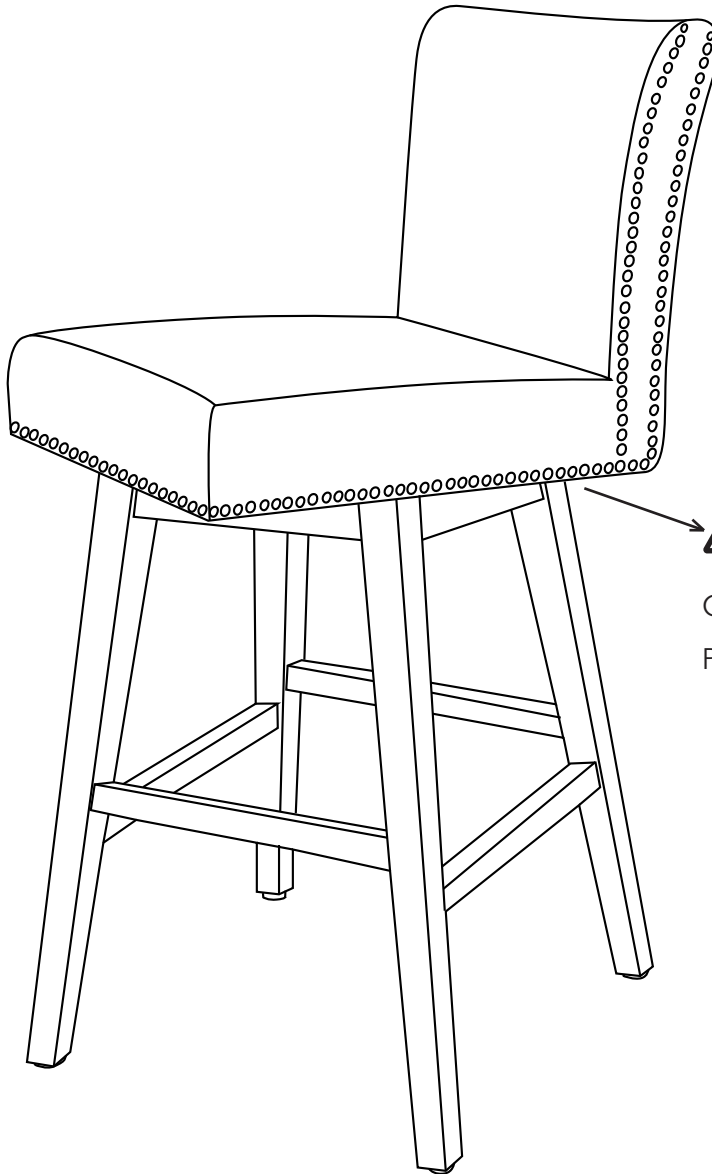

CAUTION: PINCH POINT.  
Please keep hands clear during swivel.

## **PRODUCT WARRANTY**

- 1-year limited on cover against splitting, peeling, and/or tearing.
- 1-year limited on internal and external frame structure.
- 1-year limited on cushioning material, seat springs and mechanism.

## **CARE & MAINTENANCE**

Water Based Cleaner 'W': Spot clean using the foam only from a water-based cleaning agent such as a mild detergent or non-solvent upholstery shampoo product. Apply foam with a soft in circular motion.

Vaccum when dry.

Do not place furniture in direct sunlight and keep furniture at least 60 cm / 2 feet from heat sources to avoid fading.