





ASSEMBLY INSTRUCTION / INSTRUCTION D'ASSEMBLAGE

Description : Queen Bed / Lit



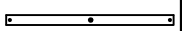

Thank you for purchasing this product. Please take time to read and follow the instructions below. Check that you have all parts and hardware before assembly .

Merci d'avoir acheté ce produit de qualité. Vérifiez avant le montage que vous avez toutes les pièces et fixations. Les pièces qui semblent manquer se trouvent souvent dans les matériaux d'emballage.

PART LIST / LISTE DE PIÈCES

NO	NAME	PART	QTY
A	Headboard /Tete de Lit		1pc
B	Footboard / Pied de lit		1pc
C	Side rail / Longerons		2pcs
D	Slat / Lattes		3pcs
E	Slat support leg / Support pour transverses		3pcs

HARDWARE LIST / LISTE DE QUINCAILLERIE

NO	NAME	PART	QTY
F	Allen key / Cle Allen		1pc
G	JCBC / Boulon 35mm		3pcs
H	M6 Spring washer / Rondelle D'arret		3pcs
I	Screw 32mm / Vis		6pcs
J	Adjustable Leveler / Nivelleur		3pcs
HARDWARE SET FOR ASSEMBLY			

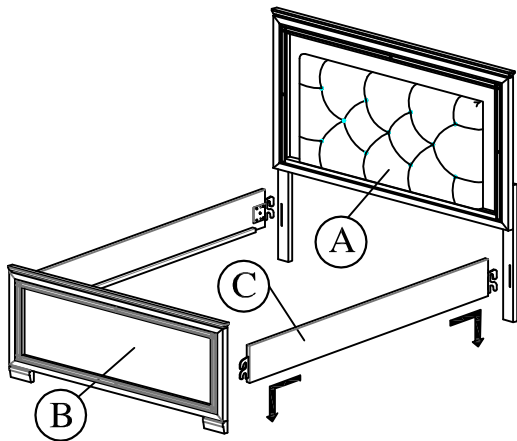

Step 1 / Etape 1 : Attach the (C) side rail to the (A) headboard & (B) footboard.

Step 2 / Etape 2: Attach (E) slat support leg to the bottom of slat using (G) JCBC 35mm & (H) M6 spring washer. Attach The (J) Adjustable leveller and adjust it to level the bed with the floor.

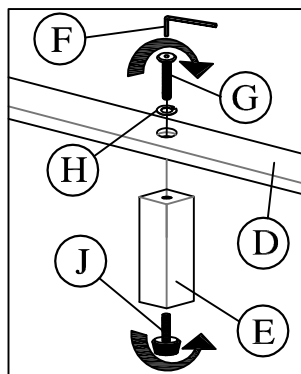

Step 3 / Etape 3: Secure the (D) slat using the (I) screw 32mm provided.

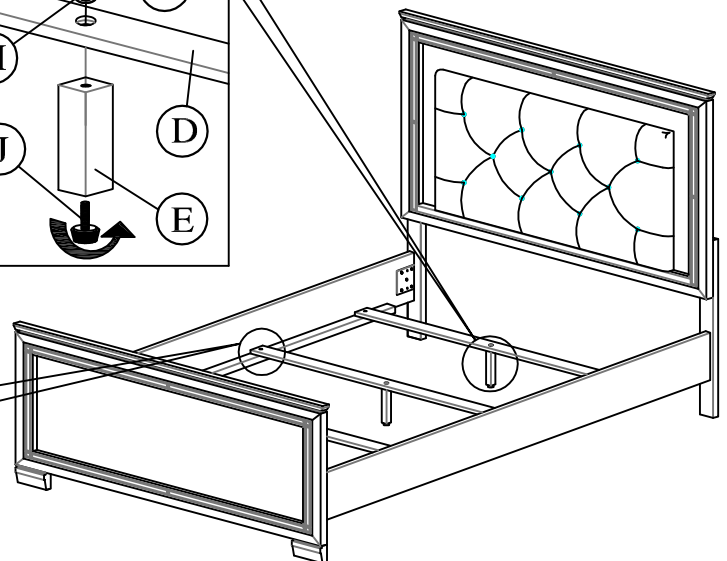
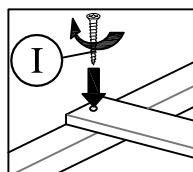

For items use on wooden floor, hard surfaces or carpets, it is recommended to Install protective pads under all legs and supports to avoid/prevent from damages/scratches and discoloration.

Pour les articles utilisés sur un plancher en bois, des surfaces dures ou tapis, il est recommandé d'installer des mordaches de protection sous tous les jambes et prend en charge pour éviter/empêcher de dommages/raures et la décoloration.