

INSTRUCTION

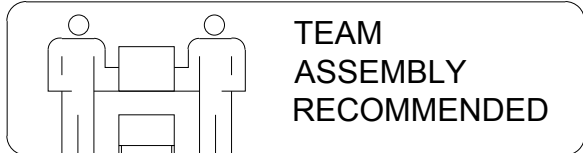

sofa

PARTS LIST

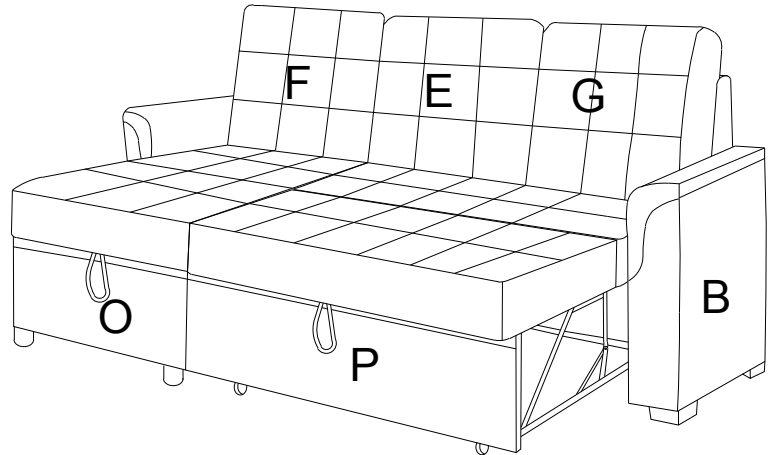
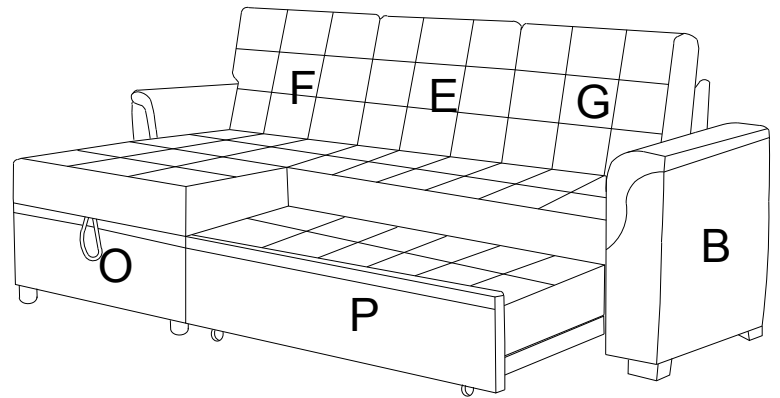
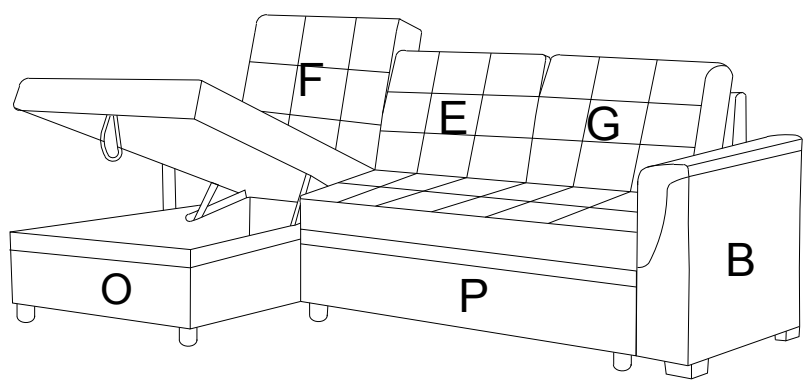
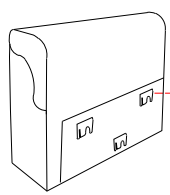

A X 1pc

Left arm

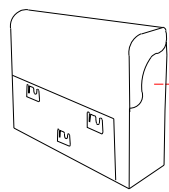

B X 1pc

Right arm

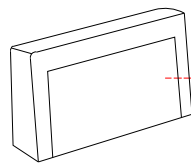

C X 1pc

Chaise back

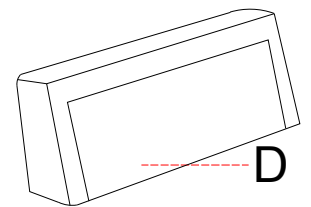

D X 1pc

Couch back

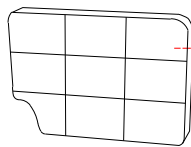

F X 1pc

Left back cushion

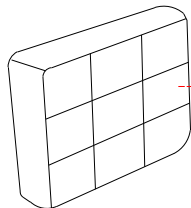

E X 1pc

Mid back cushion

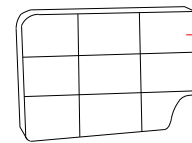

G X 1pc

Right back cushion

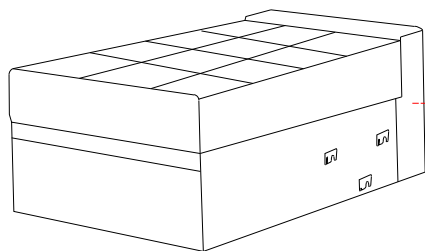

O X 1pc

Chaise

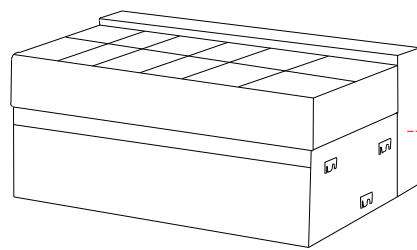

P X 1pc

Couch

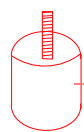

H X 8pc

Legs

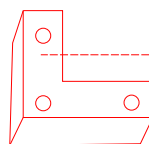

I X 4pc

L-Shaped Hardwar

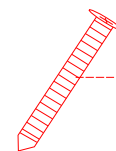

J X 12pc

Long screw

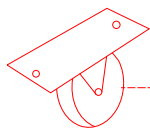

K X 2pc

Wheels

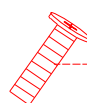

L X 4pc

Short screw

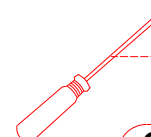

M X 1pc

Screwdriver

STEP 1

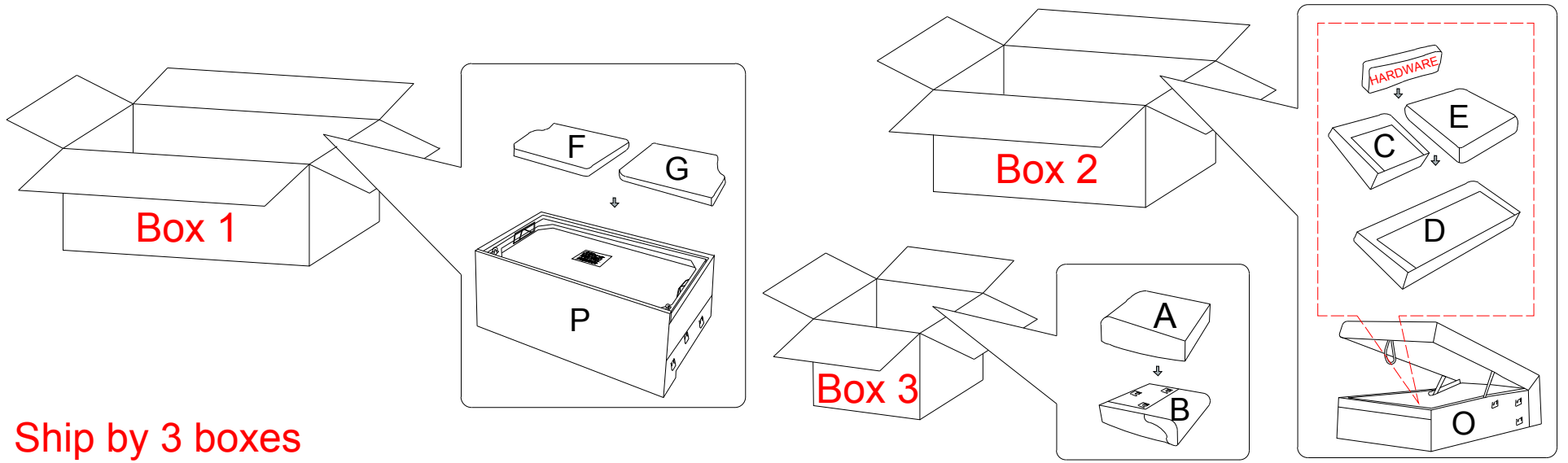

STEP 2

Parts and hardware can be found in the part O. Pull up the rope and pull out the part C, D, E and hardware.

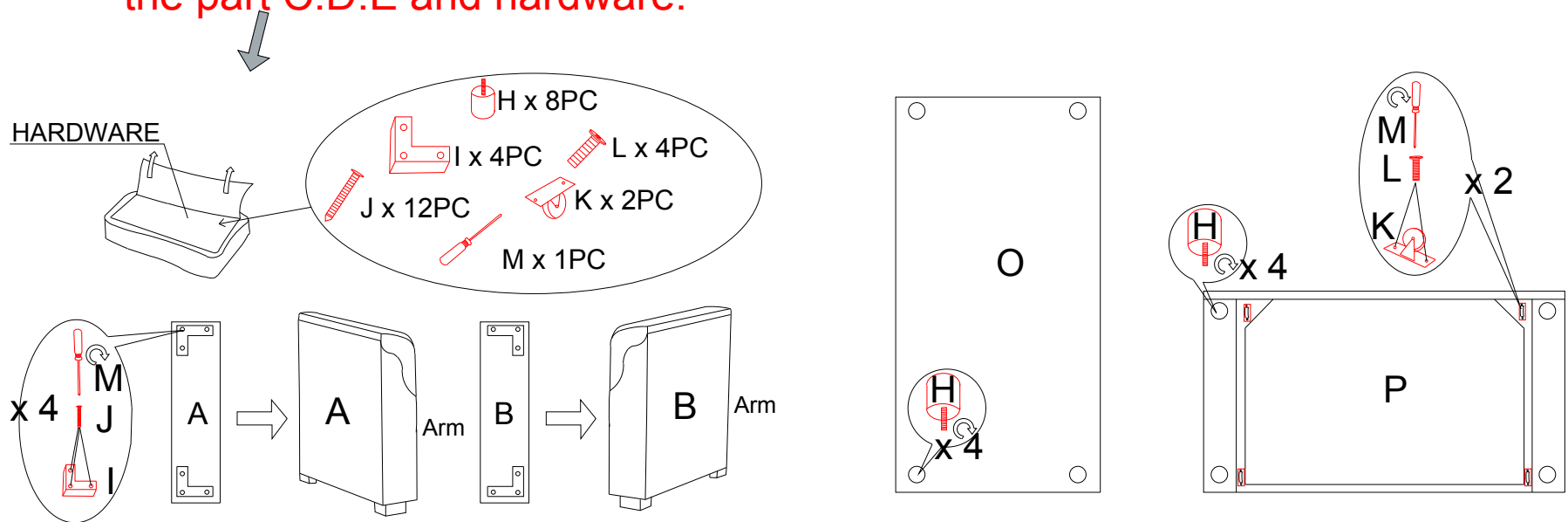

STEP 3

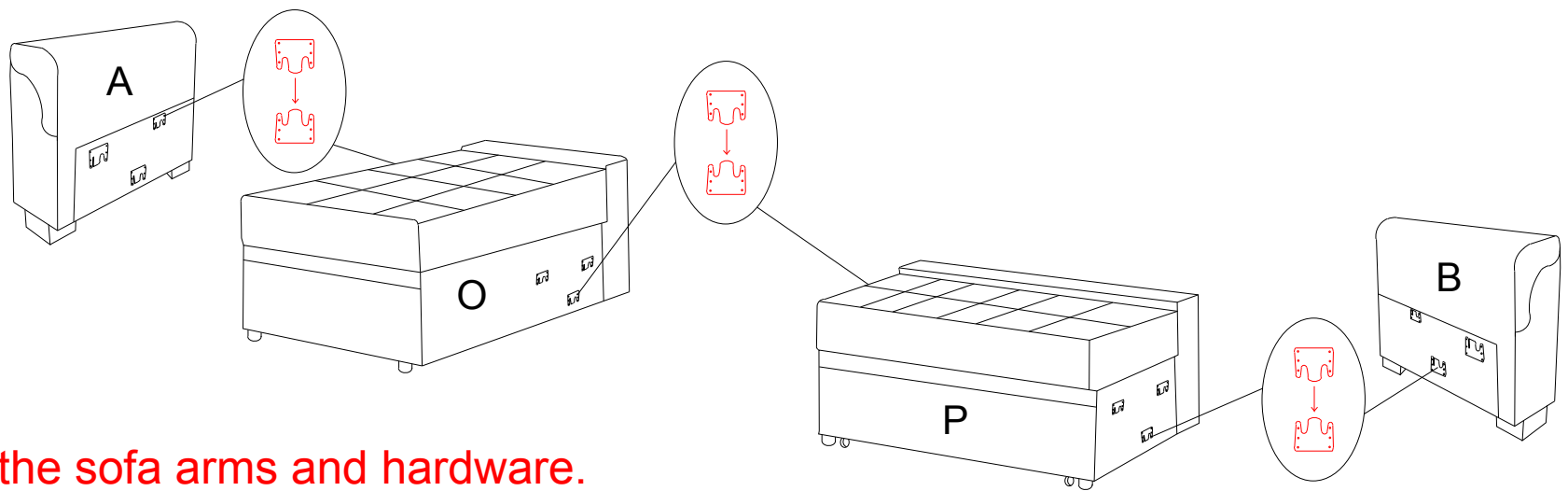

STEP 4

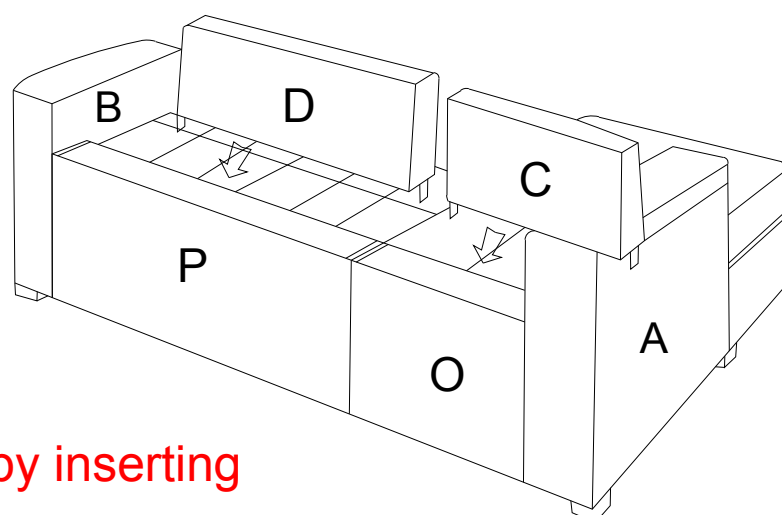

STEP 5

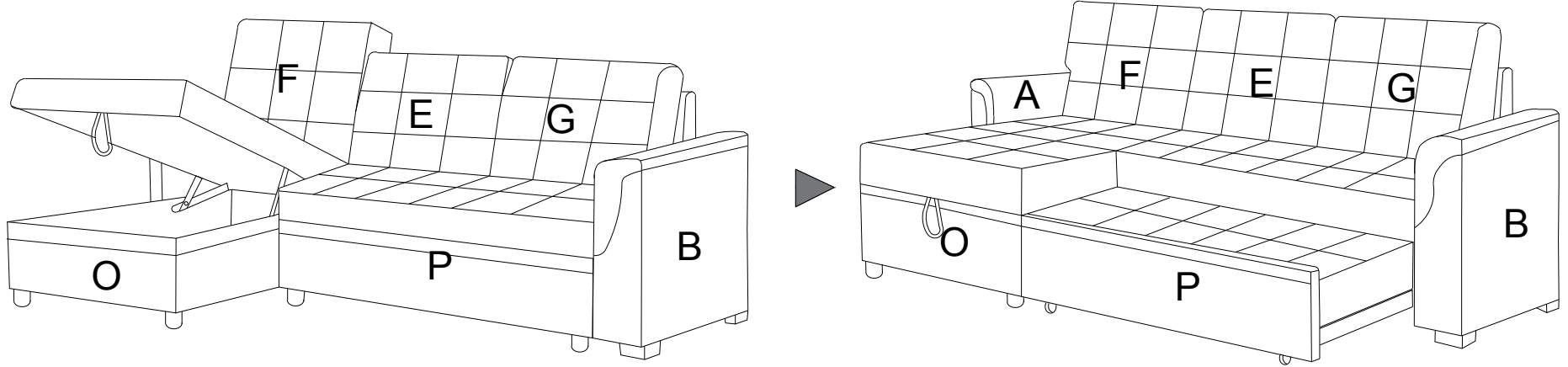

STEP 6

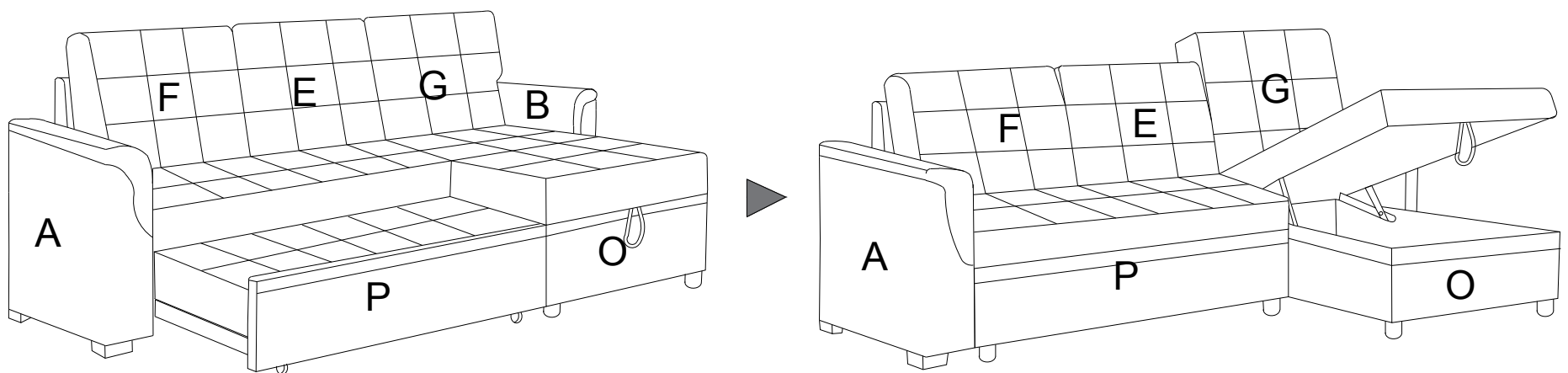

Notice:

Thank you for purchasing this quality product. Be sure to check all the packing material carefully for small parts, which may have come loose inside the carton during shipment. Identify and count all parts and compare with Part List on Page 1.