



















# 20X20FT

Quantity	Item	Length	Description
8	A 	124mm	Rafter $\Phi$ 38mm
8	B 	193mm	Rafter $\Phi$ 38mm
15	C 	189mm	Apex and eave pole $\Phi$ 38mm
8	D 	189mm	Leg $\Phi$ 38mm
4	E 	189mm	Ruggedized tube $\Phi$ 31mm
6	F 		3 way joint
6	G 		4 way joint
4	H1 		Base plate
4	H2 		Base plate
8	I 		3 way joint
12			Peg
4			Peg
1			Gloves
16			Peg
84			Bungee
4			Guy lines
1			Roof
2			Wall panel
2			End panel

## IMPORTANT:

We do not recommend leaving set-up over several days, in windy or adverse weather conditions.

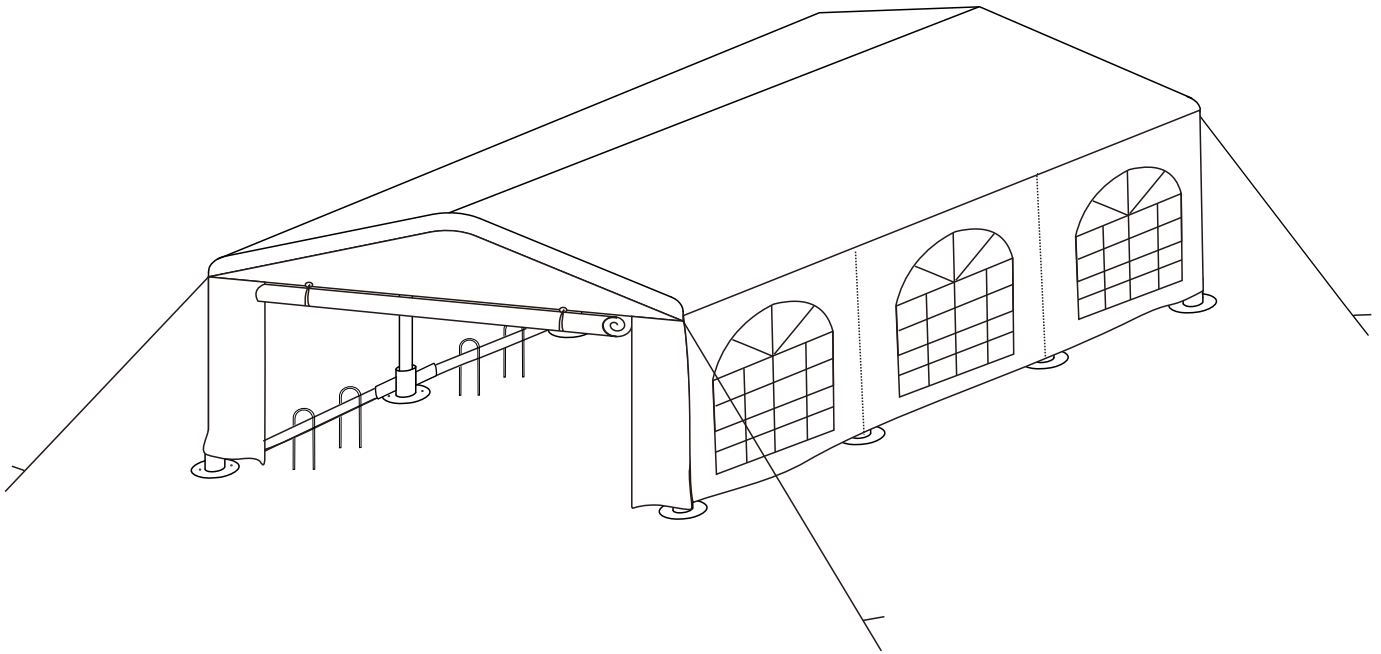

### Warning:

1. When assembling and using this product, basic safety precautions should always be followed to reduce the risk of personal injury and damage to equipment. Please read all instructions before assembly and use.
2. Some parts may contain sharp edges, wear protective gloves if necessary. At least four or more people are recommended for safe assembly.
3. Keep all children and pets away from assembly area.
4. Begin assembly not less than 6 feet from any obstruction such as fence, garage, house, overhanging branches, laundry line or electrical wires.
5. Install on level ground. This gazebo cannot be permanently staked or attached to concrete floor or platform. The provided stakes are for soft ground use only. If assembling on a hard surface like a deck or concrete, other forms of attachment must be used such as expansion bolts that can be purchased locally.
6. This gazebo is intended for decorative and sunshade purposes only and is not meant to withstand inclement weather including high winds, rain and snow. Gazebo fabric is water resistant, not water proof and may leak during exposure to precipitation.
7. Please lay out all parts before assembling, check out if there is any parts missing or not.
8. KEEP ALL FLAME AND HEAT SOURCES AWAY FROM THIS TENT FABRIC.

Step1:

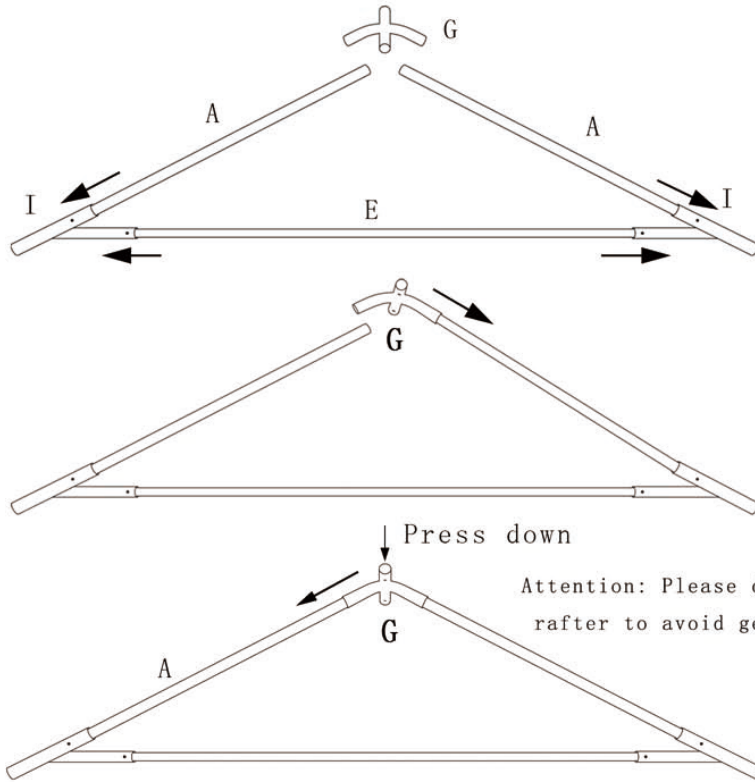

Attention: Please don't put your hand on the "A" rafter to avoid getting caught in the "G".

Step2: Repeat the above steps.

Step3:

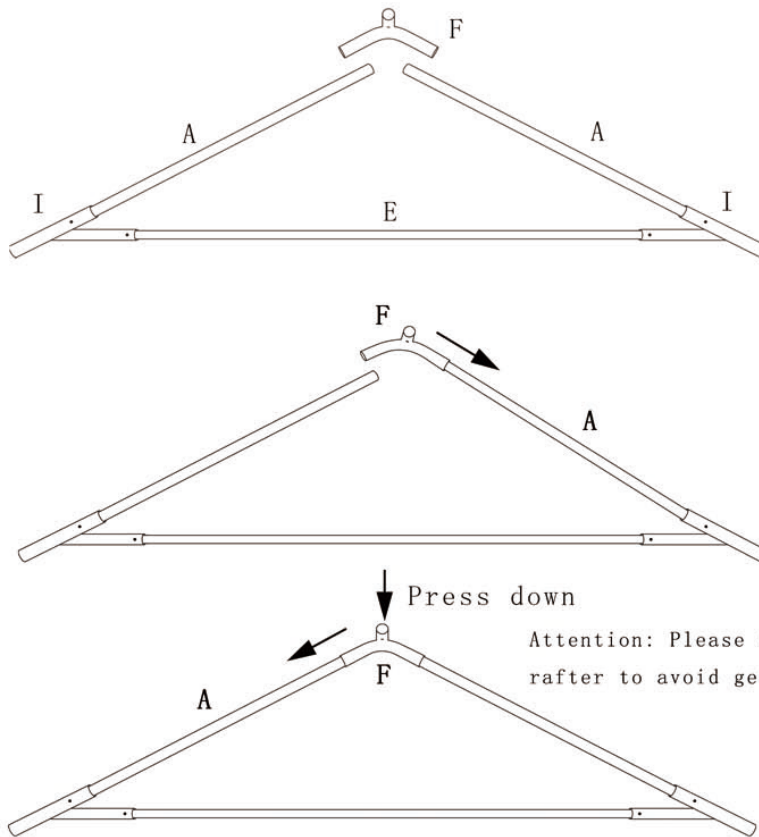

Attention: Please don't put your hand on the "A" rafter to avoid getting caught in the "F".

Step4: Repeat the above steps.

Step5:

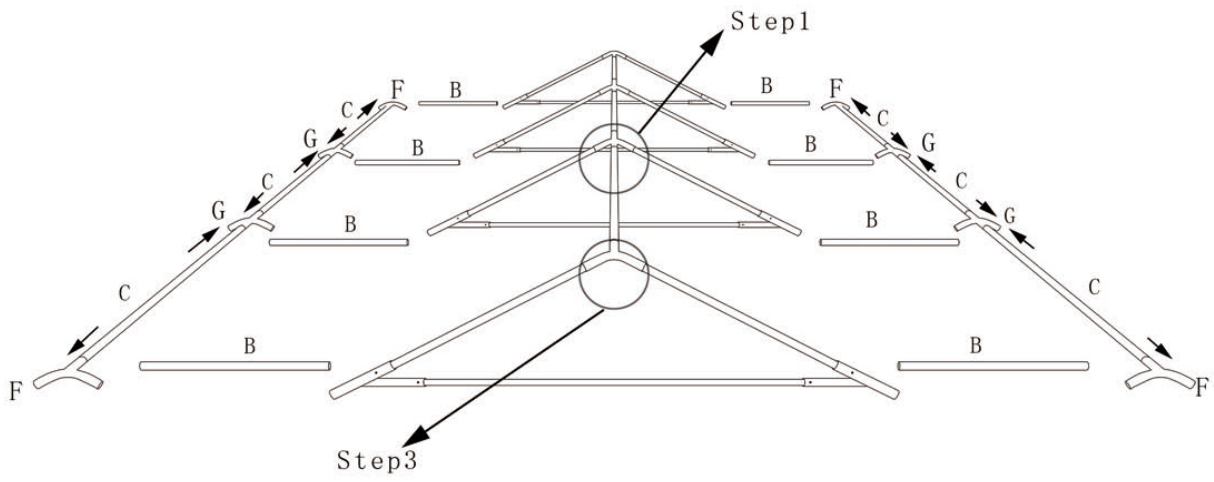

Step6:

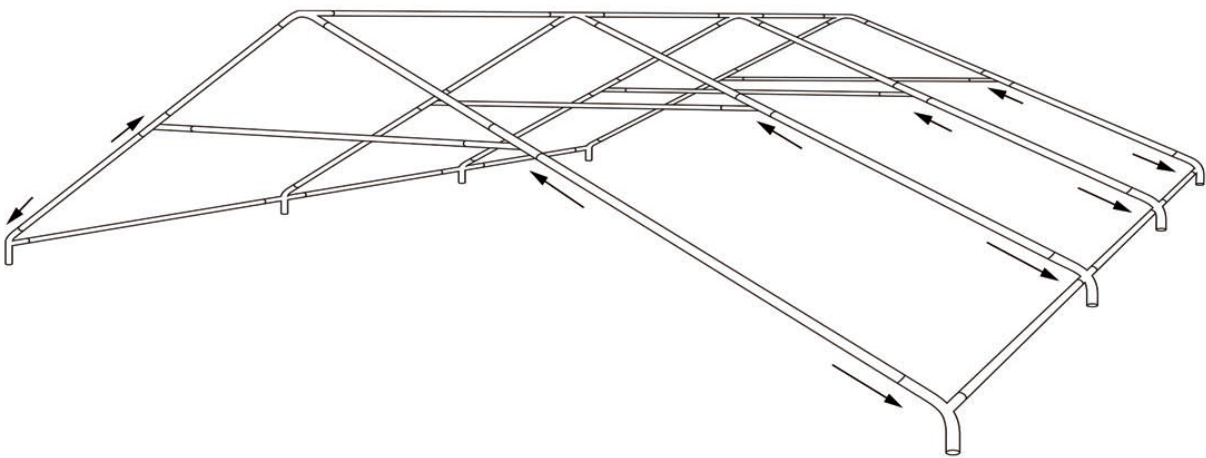

Step7: Install The "roof"

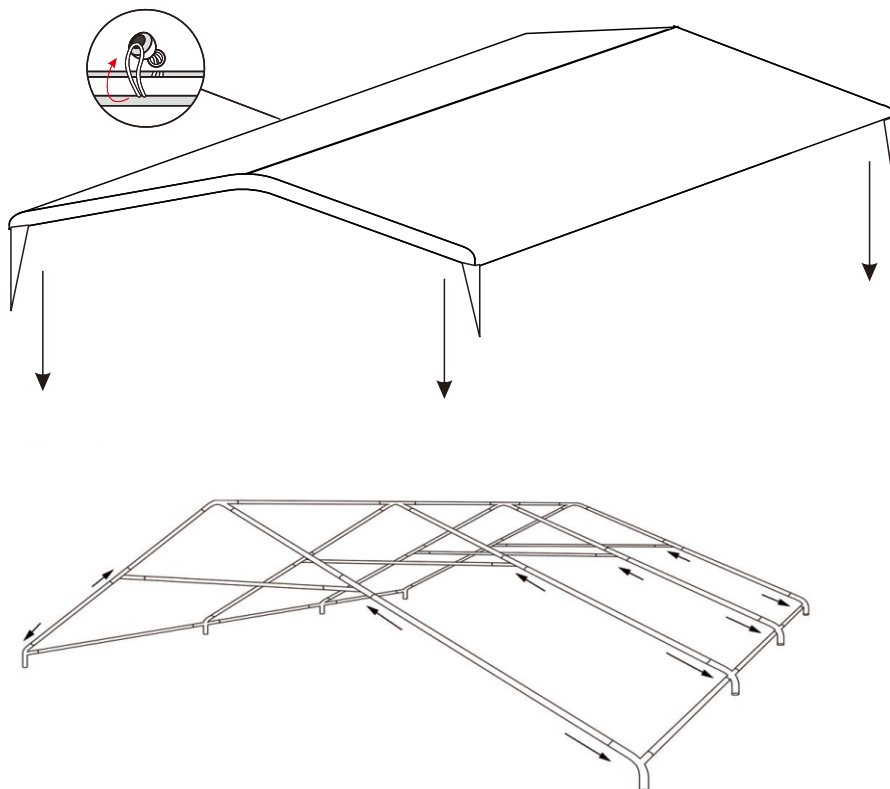

Step8:

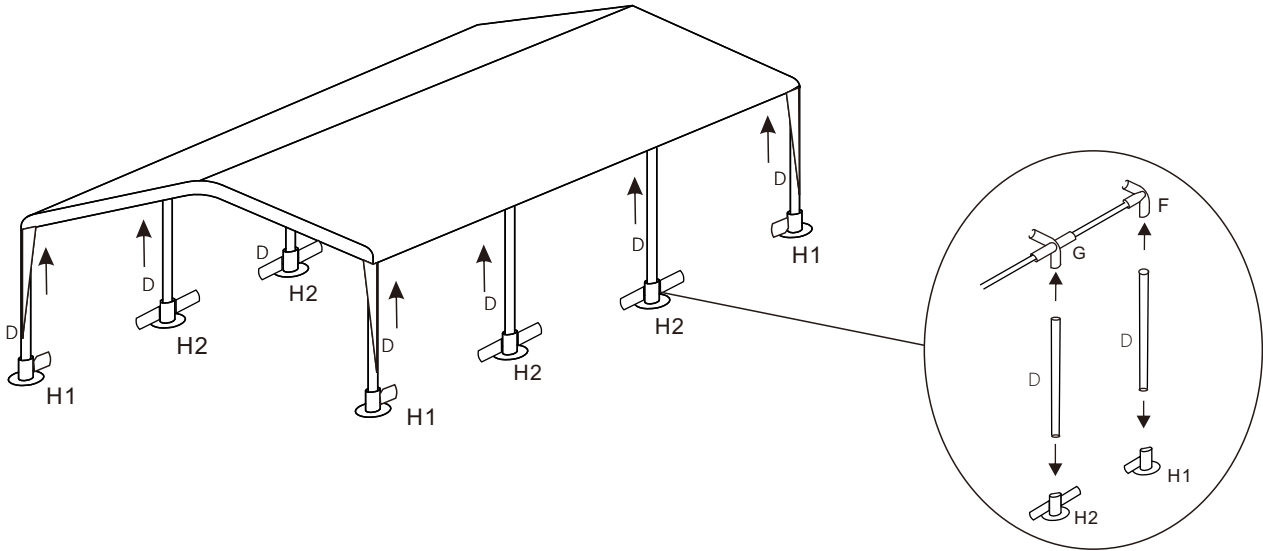

Step9:

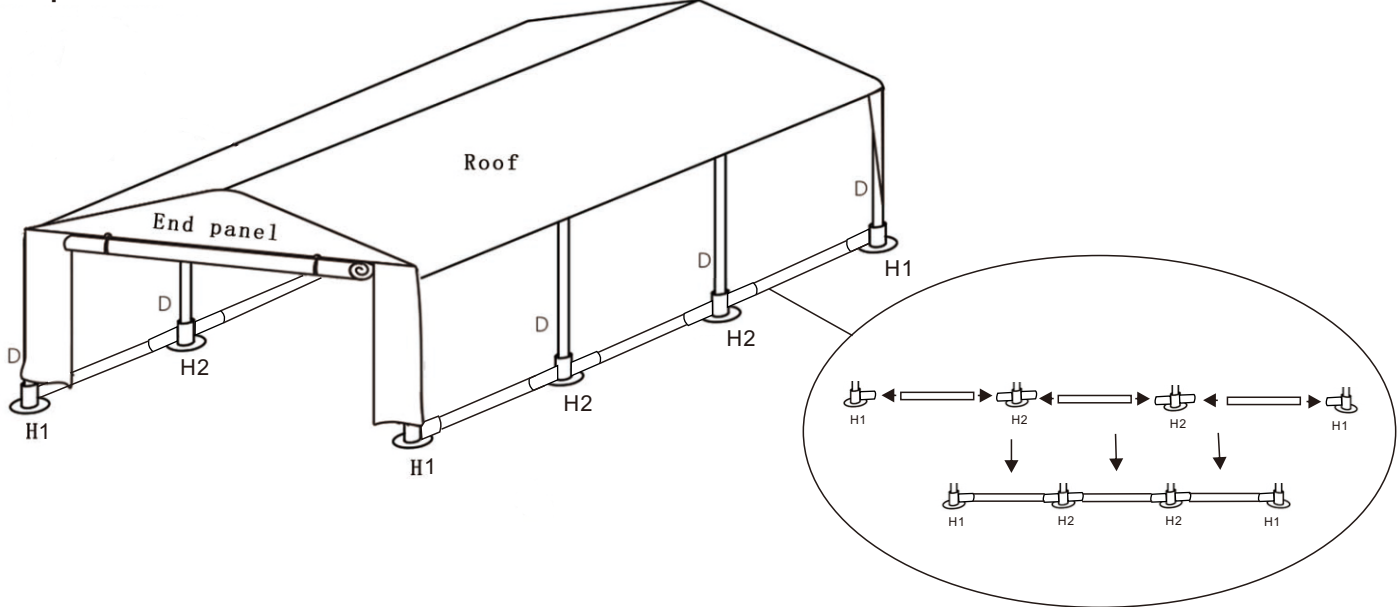

Step10:

