

ASSEMBLY INSTRUCTIONS:

TWIN BED





Thank you for purchasing this quality product. Before beginning, please check the packing material carefully for small parts which may have come loose inside the carton during shipping. Please do not discard any packing material until all parts have been located. If any parts are missing, please contact your dealer for prompt replacement.





Caution: (1) These parts are cumbersome and heavy. This product can best be assembled with the assistance of one or more persons in order to prevent personal injury and to insure parts are not damaged during the assembly process. If dirty, clean finished parts with mild dishwashing liquid and water solution applied on damp cloth. Cloth should not be excessively wet. Polish finish with soft cloth and an industry recognized furniture polish.

(2) To prevent damage to your floor or carpet, please check the bottom of each piece of furniture for stain residue and rough surfaces and also check for staples or nails left after removing the packaging material. The manufacturer will not be held responsible if preventative steps are not taken prior to installation.

(3) During normal use everyday, screws, bolts, nuts and wooden plugs may loosen up. They should be periodically inspected and re-tightened to prevent damage to the furniture and (or) personal property or cause injury. Always check to be sure all hardware on this list and the below mentioned components are attached to the furniture properly and kept tightened.

PARTS & HARDWARE LIST:

PARTS LIST			Q'TY	PARTS LIST			Q'TY
A	HEADBOARD		1 Pc	C	SIDE RAIL		2 Pcs
B	FOOTBOARD		1 Pc	D	SLAT RAIL		12 Pcs

HARDWARE LIST			Q'TY
1	Full Thread Bolt (5/16" x 3")		8 Pcs
2	Curve washer (5/16")		8 Pcs
3	Hex. Nut (Ø5/16" x 1/4")		8 Pcs
4	Open Wrench (#1/2")		1 Pc
5	Screw (#4 x 1" mm)		24 Pcs

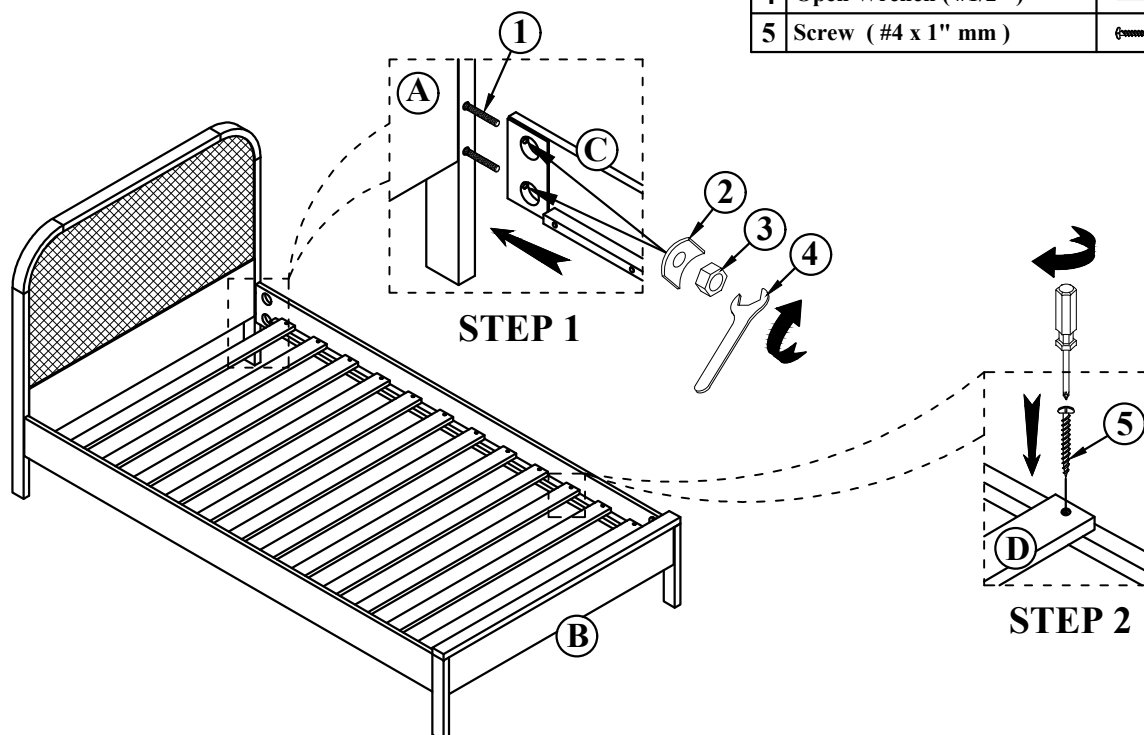

ASSEMBLY PROCEDURES:

* Lay out all parts and hardware. Make sure the quantity of each is correct and the feet are free of stain, staples screws and nails. *

Step 1: Assemble the Side Rail (C) to the Headboard (A) and Footboard (B) using hardware (1 , 2 , 3 , 4) as shown.

Step 2: Assemble the Slat Rail (D) on the Side Rail (C) using the Screw (5) as shown.

ASSEMBLY IS COMPLETE.