

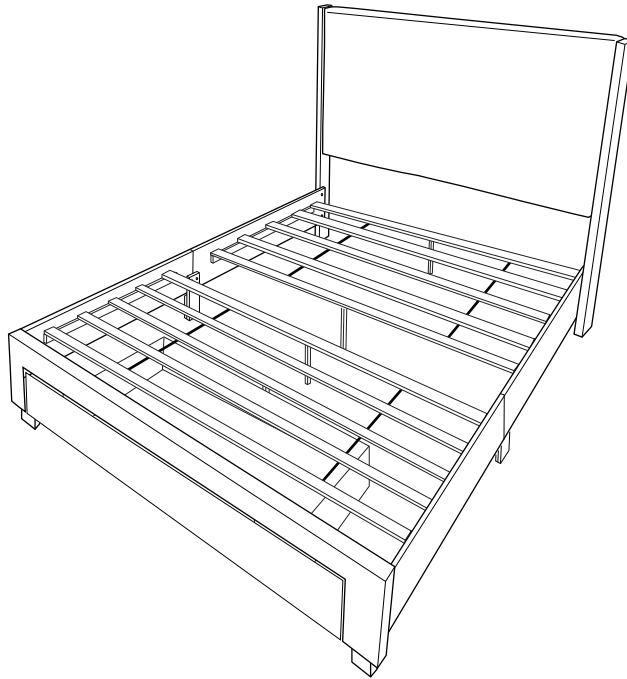

# ASSEMBLY INSTRUCTION

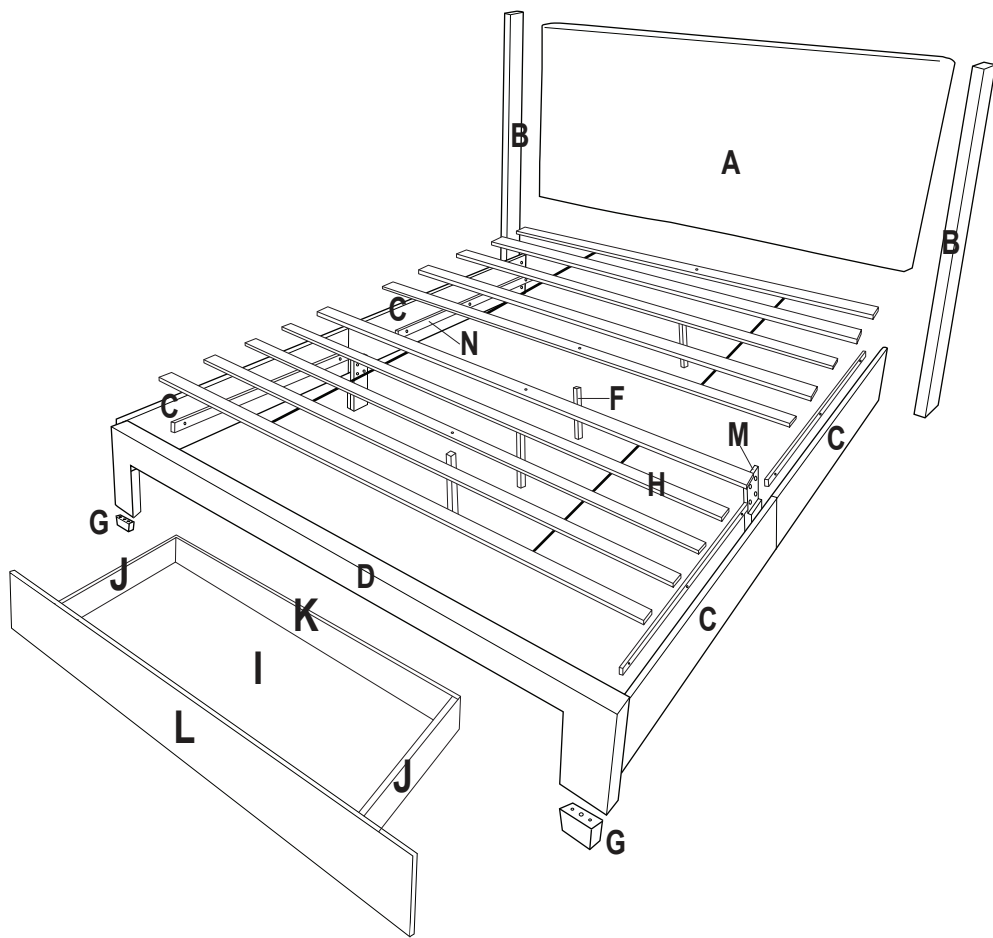

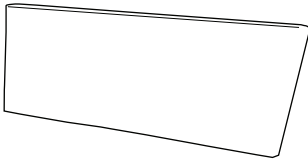

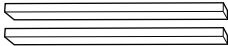
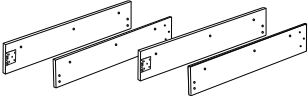
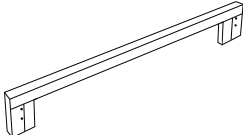
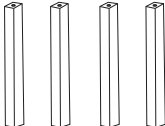
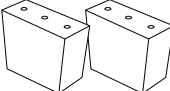

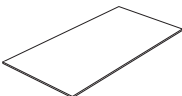
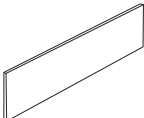
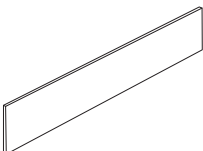
SRN-4011T

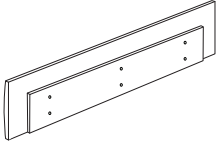
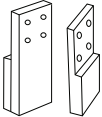
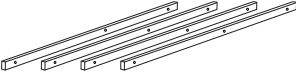

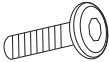

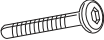
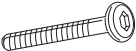
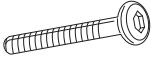
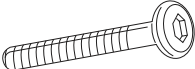
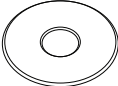
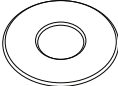
NO	PART LIST	QTY
A	Headboard 	1 pc
B	Wing 	2 pcs
C	Side Rail 	4 pcs
D	Footboard 	1 pc
F	Center Support Leg 	4 pcs
G	Bed Leg 	2 pcs
H	Bed Slat 	10 pcs
I	Drawer Bottom Panel 	1 pc
J	Drawer Side Panel 	2 pcs
K	Drawer Back Panel 	1 pcs

NO	PART LIST	QTY
L	Drawer Front Panel 	1 pcs
M	Side Rail Support 	2 pcs
N	Slat Support 	4 pcs

NO	HARDWARE LIST	QTY
1	JCBB M8 x 20mm 	4 pcs
2	JCBB M8 x 50mm 	6 pcs
3	JCBC M6 x 25mm 	8 pcs
4	JCBC M6 x 30mm 	12 pcs
5	JCBC M6 x 35mm 	6 pcs
6	JCBC M6 x 60mm 	4 pcs
7	JCBC M6 x 70mm 	2 pcs
8	Flat Washer M6 	14 pcs
9	Flat Washer M8 	6 pcs
10	Adjuster M6 	4 pcs
11	CSK M4 x 30mm 	28 pcs
12	CSK M3.5 x 12mm 	12 pcs
13	Dowel M8 	4 pcs

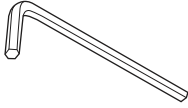
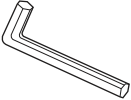
NO	HARDWARE LIST	QTY
14	Wheel 	4 pcs
15	Allen Key M4 	1 pc
16	Allen Key M5 	1 pc

Read this instruction carefully. Remove all wrapping material, staples and straps from the carton. See hardware and furniture part list for guidance. Be sure you have all wooden furniture parts on a clean and flat surface, such as carpet or rug, to prevent from being scratched.

**CAUTION :**

1. Do not Full Tighten the nut or screw until all ready to assemble.
2. Do not Over Tighten the nut or screw to avoid causing damages to the thread.
3. Keep all hardware part out reach of children.

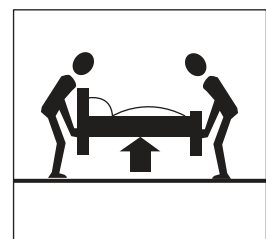
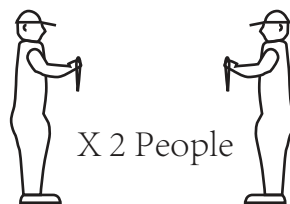

STEP 1 Drawer x 1pc



! Use screw driver only

11	12	14
8 pcs	12 pcs	4 pcs

Step 1

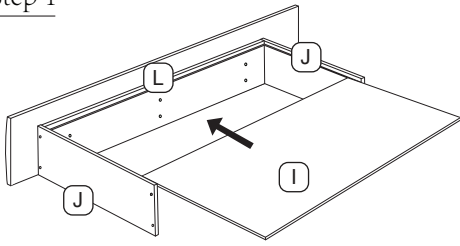

Step 3

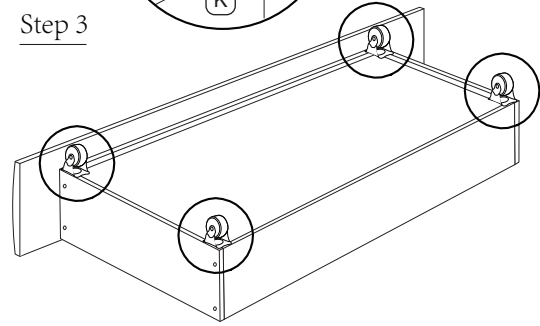
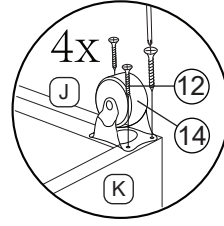

COMPLETED ASSEMBLY

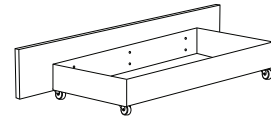

Step 2

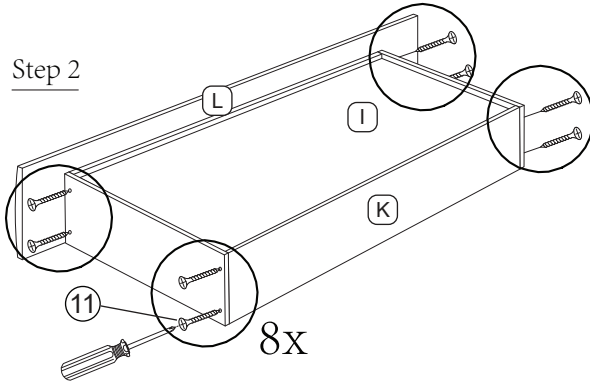

STEP 2

5	7	8	13
6 pcs	2 pcs	6 pcs	4 pcs

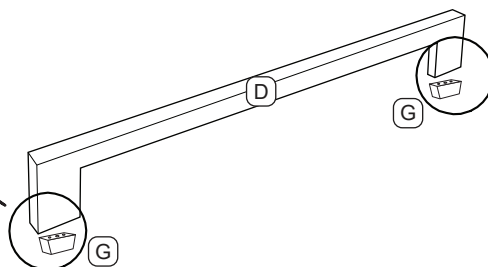
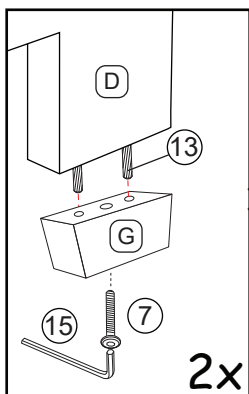
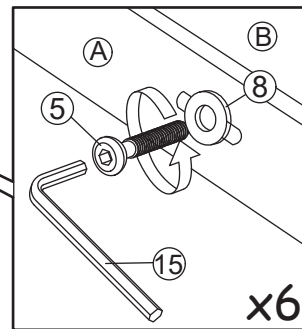
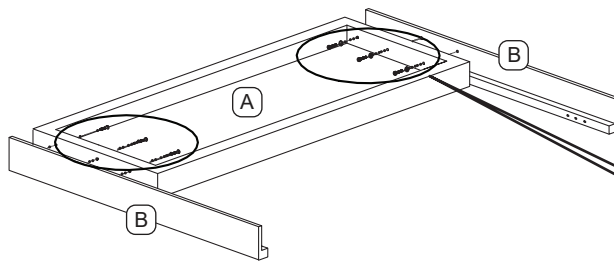

STEP 3

3	4	8
8 pcs	12 pcs	8 pcs

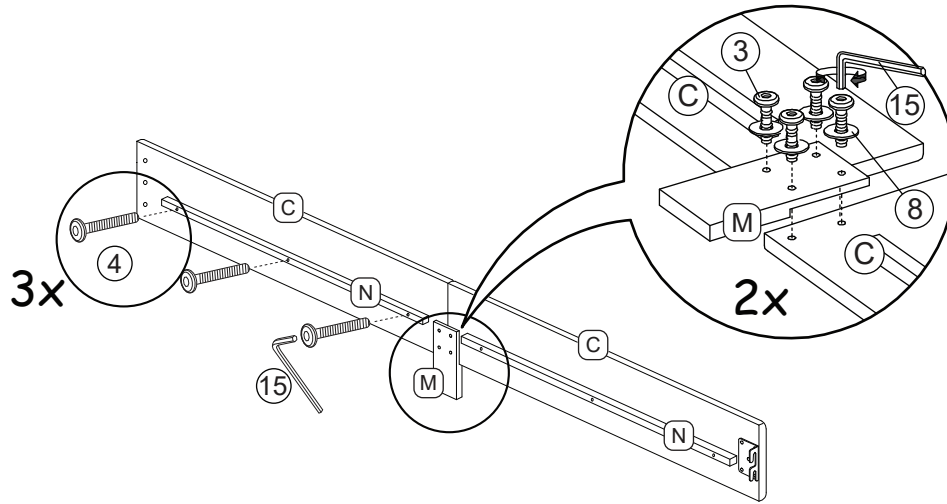

STEP 4

1	2	9
4 pcs	6 pcs	6 pcs

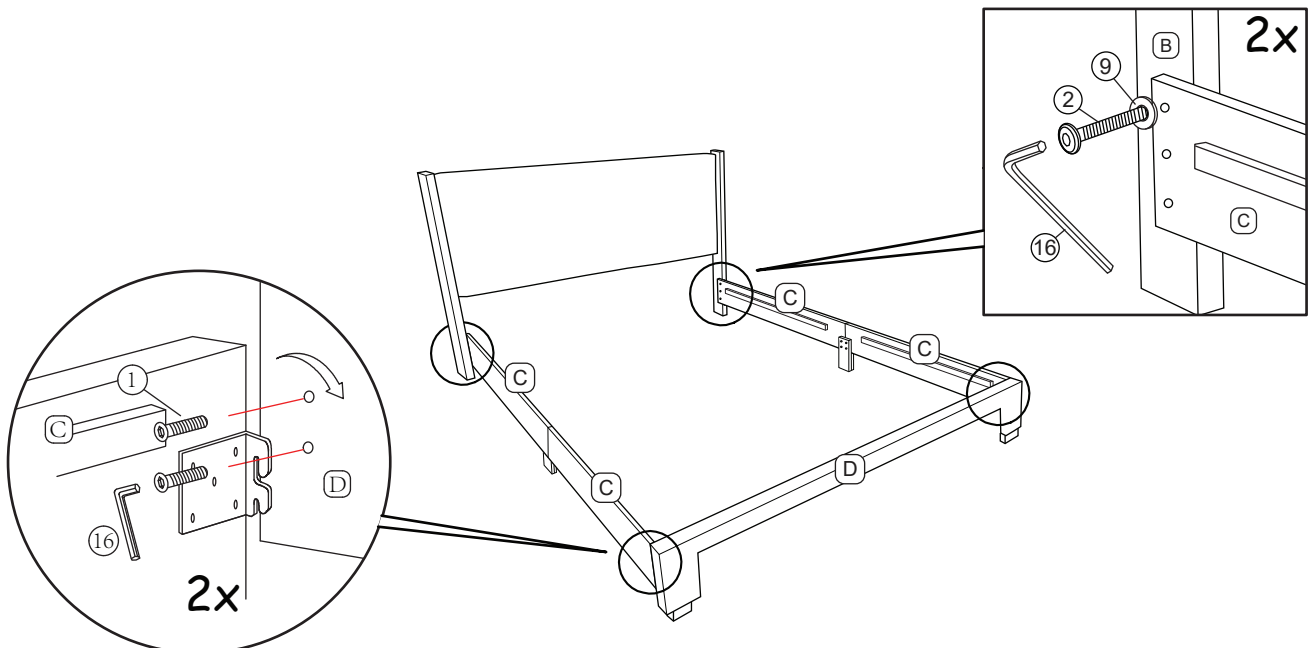

STEP 5

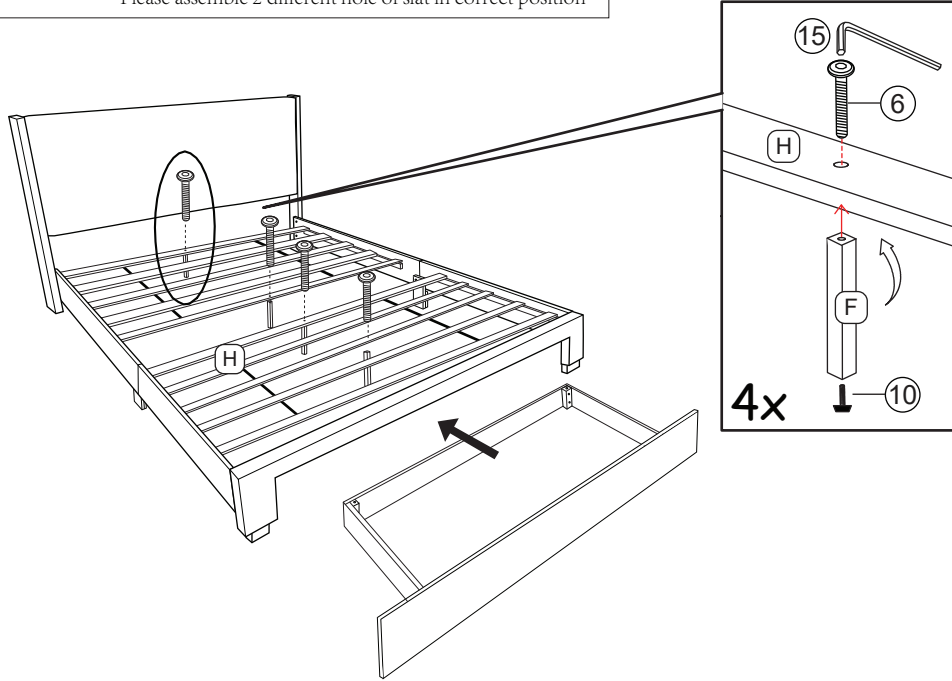
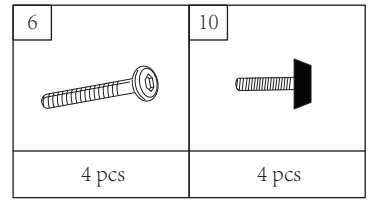
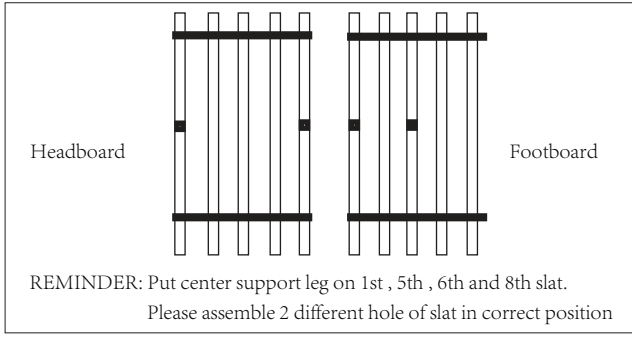

STEP 6

