

Assembly Instruction

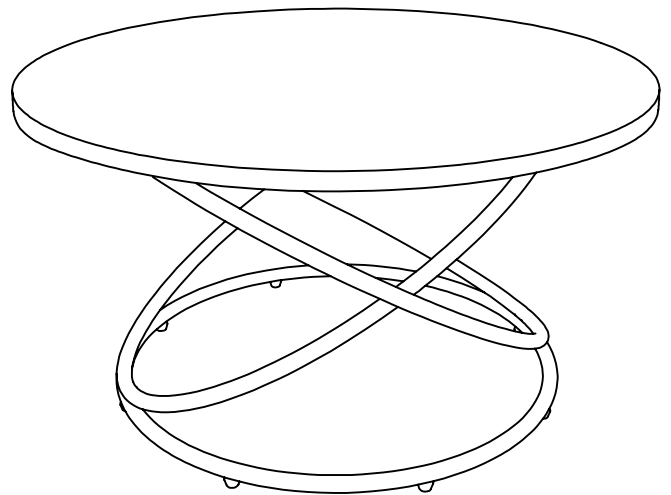

Coffee table & Dining table

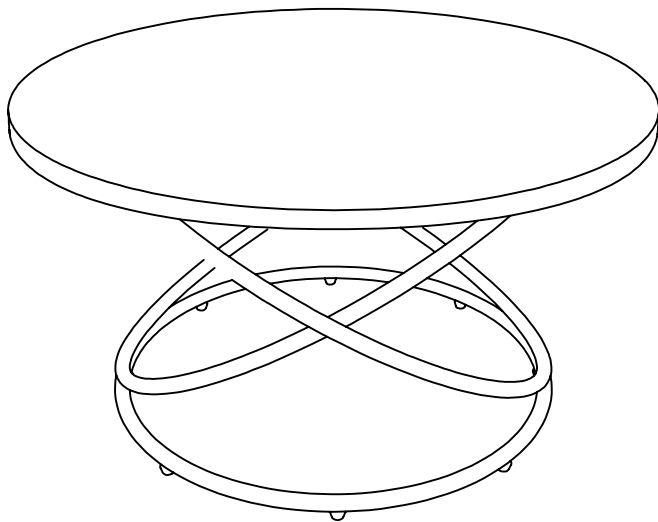



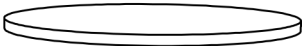
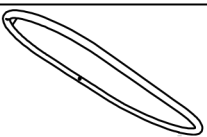
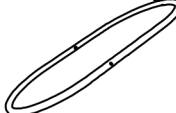

ASSEMBLY TIPS:

1. Remove hardware from box and sort by size.
2. Please check to see that all hardware and parts are present prior to start of assembly.
3. Please follow attached instructions in the same sequence as numbered to assure fast & easy assembly.

Parts List

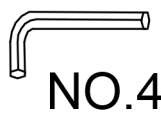
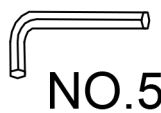
Number	Name	Part	Qty
1	Desktop		x1PC
2	Leg		x1PC
3	Leg		x1PC
4	Footrest		x1PC

Number	Hardware	Part	Qty
A	M6*30mm		x6+1EXT
B	M6*16mm		x4+1EXT
C	Allen Wrench	 NO.4	x1PC
D	Allen Wrench	 NO.5	x1PC
E	Foot		x8+1EXT

1

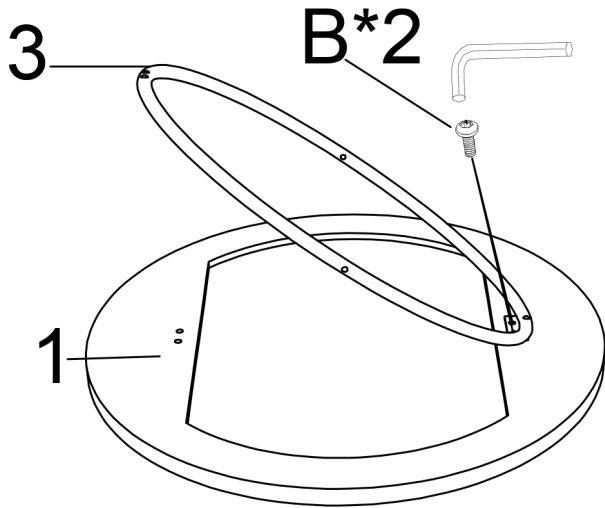
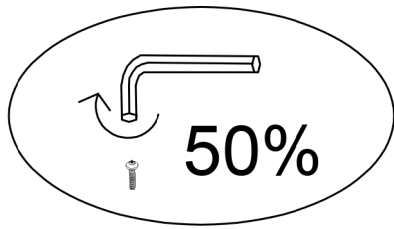

2

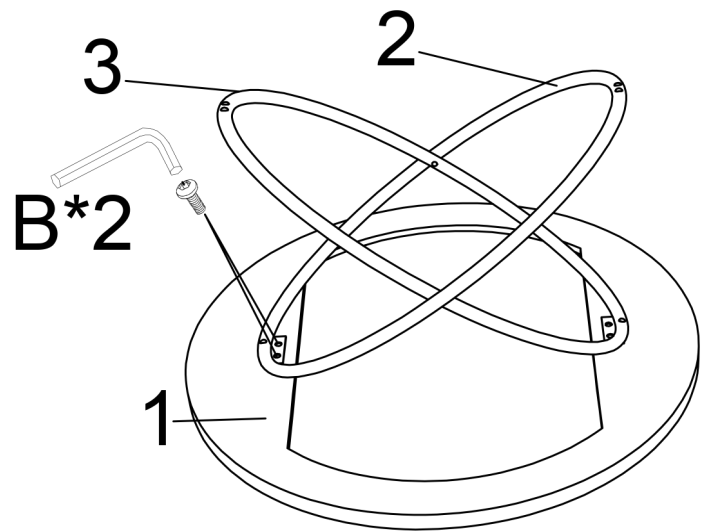
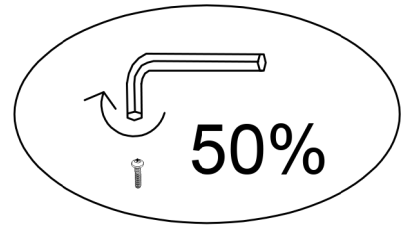

3

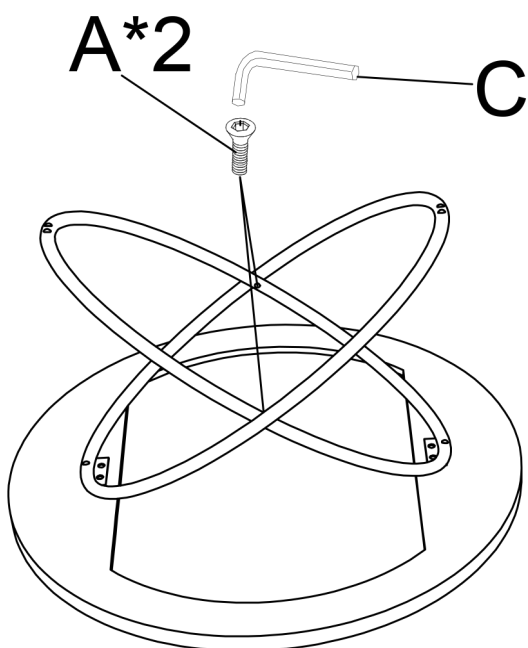
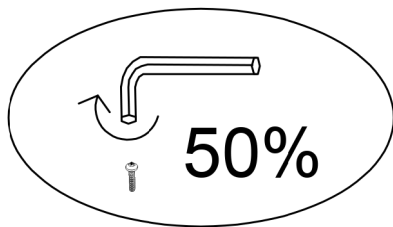

4

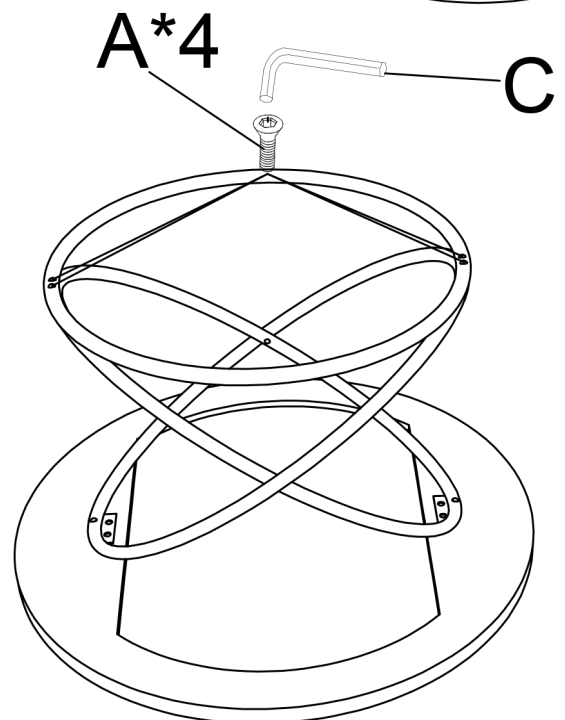
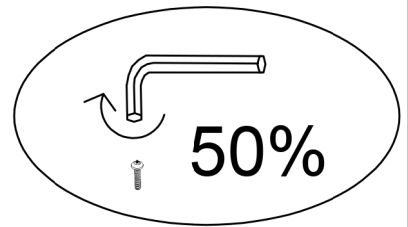

5

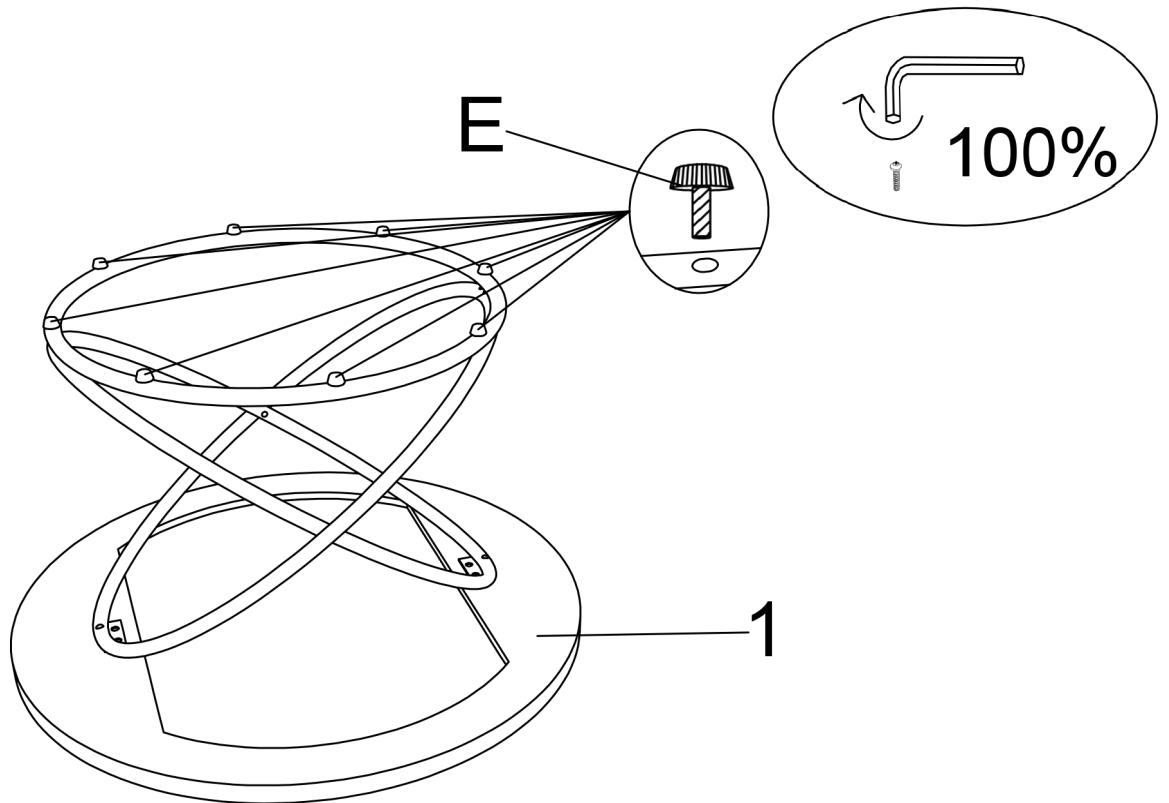

Fasten all screws, including step 1 and step 2, step 3, step 4.

6

Rotate it to ensure the table is flat on the floor !

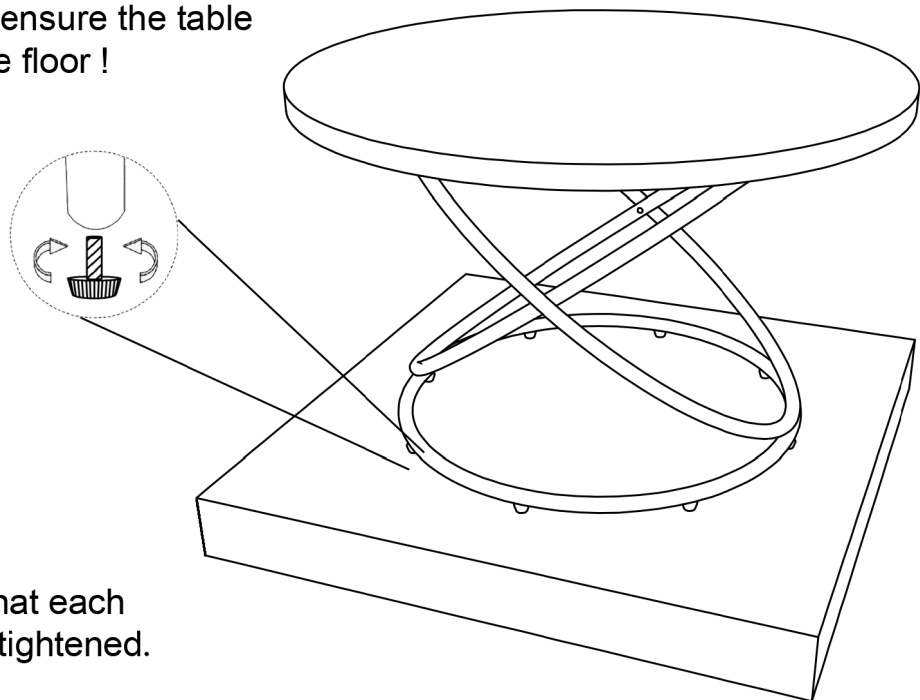

Ensure that each screw is tightened.

Additional Note About Safety: Bolts may loosen during normal everyday use. They should be periodically inspected and tightened to prevent damage or injury. Always check to be sure that all hardware is kept tightened. Thank you for your purchase.