

ASSEMBLY INSTRUCTIONS

Please identify and locate all assembly parts (see parts list) before discarding any packing materials.

Some parts may have become loose during transit.

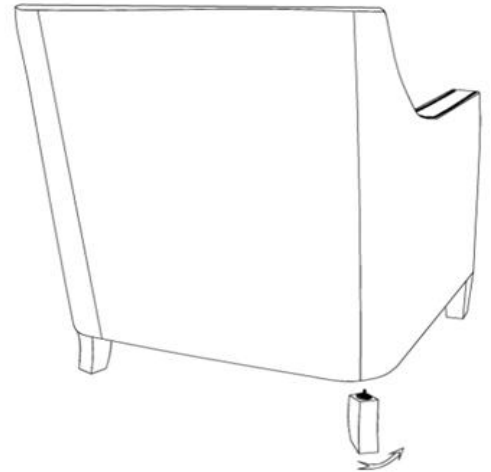
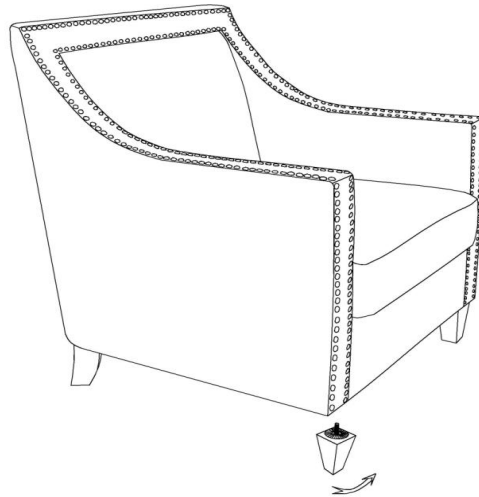
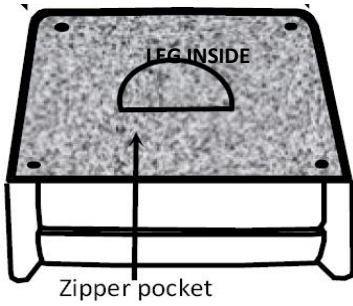

Step 1: TURN CHAIR (A) UPSIDE DOWN AND UNZIP POCKETS TO FIND LEGS AND HARDWARE. PLEASE TAKE OUT FOR ASSEMBLY.

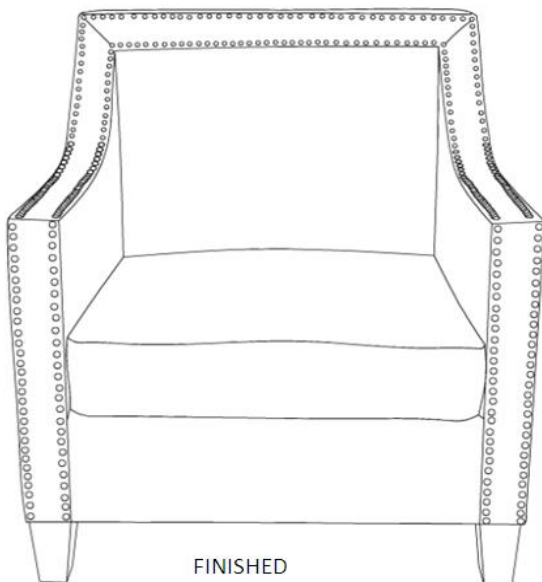

Complete: CONGRATULATIONS ON YOUR ASSEMBLE SUCCESS.



PARTS LIST:

NO.	DESCRIPTION	PHOTO	QTY
A	CHAIR		1PCS
B	FRONT LEG		2PCS
C	BACK LEG		2PCS