

Instructions

NOTE :

1. Please Check whether the accessories are missing in time after unpacking. (Bulbs not included)
2. We offer 12 months guarantee. If you find any damaged or missing parts in transit, please feel free to contact us by email , we will solve it ASAP!

Wire connector

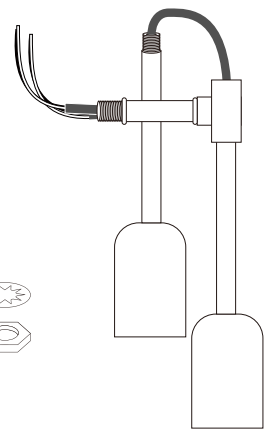
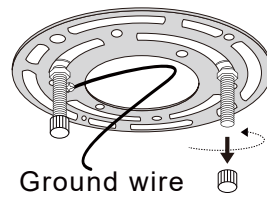
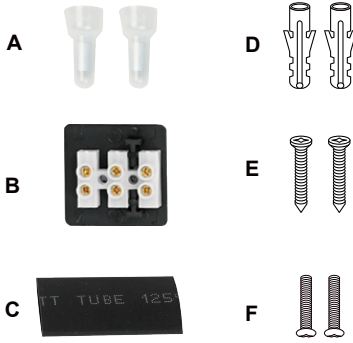

01 Tighten it

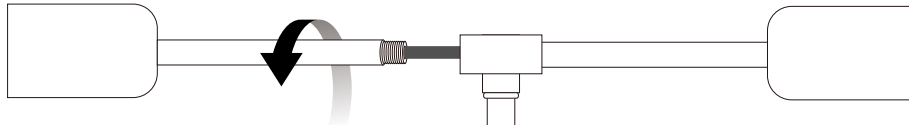

02 Install the ceiling plate

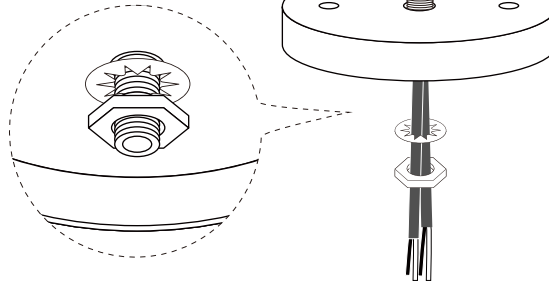

03 Screw the Mounting Bracket to the wall or junction box . (There are many gaps, you can screw it to the wall.)

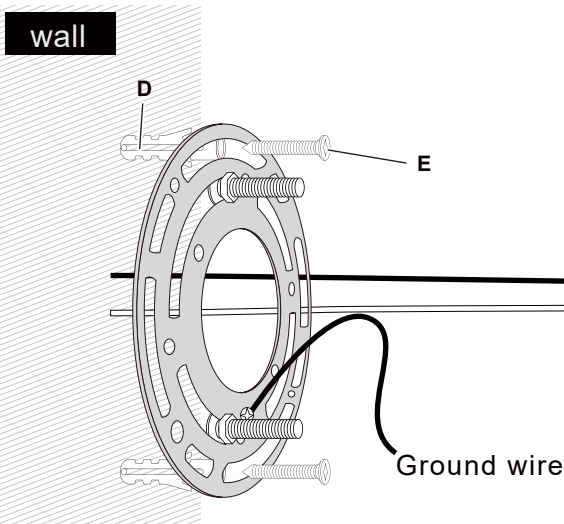

If you install the Mounting Bracket into the electrical box, please use F to fix it instead of E.

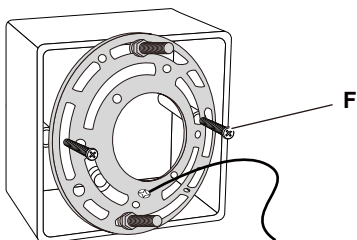

04

Fixture wires should be connected to ceiling wires by color, black wire to be attached to the black wire, white to white and ground wire to ground wire.

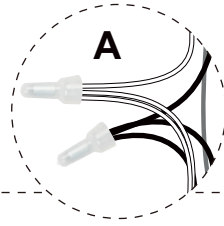

For your safety, you should use wire connector A or B as you like, if you choose connector A, you need to use Electric tape for it.

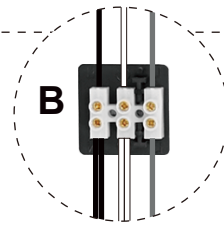

05

Fix the light to the ceiling

