



INSTRUCTION MANUAL

Loosely assemble before tightening.

IF YOU PURCHASED THIS CHAIR & TABLE ONLINE AND HAVE ANY
QUESTIONS OR CONCERNS

Lost accessories or parts costs will be incurred after 90 days of the date of purchase.

Date of Manufacture: 25W01

WARNING:

Proper use of the chair is for single person seating only. The chair is not to be used for standing purposes and will not function as a stool or step-ladder. Use on even surfaces only. Chair tested for use at weight of 300lbs (136.1kg) per seat. Maximum safe load within 350lbs per seat. Improper use of this product or failure to use as directed may result in injury.

Not intended for commercial use.

IMPORTANT:

Please read all the instructions and warnings before assembling. In order to make the whole product adjust to the best, please install all the screws on the product before fully tighten, and note to put the washer to the screw before putting the screw into the screw hole.

SAFETY INFORMATION:

- Keep children and pets away from assembly area. Children and pets should be supervised when they are in the area of the product construction.
- Keep assembly area at least 6 feet from any obstruction such as a fence, garage, house, overhanging branches, laundry line or electrical wires.
- Some parts may contain sharp edges. When assembling and using this product, basic safety precautions should always be followed to reduce the risk of personal injury and damage to the product. Please read all instructions before assembly and use.
- Check all bolts for tightness before use. **IMPORTANT** - check and tighten bolts often to keep them secure!
- The chair is not to be used for standing purposes and will not function as a stool or step-ladder. Use on even surfaces only.
- The chair use at weight of 300lbs (136.1kg) per seat. Improper use of this product or failure to use as directed may result in injury. Not intended for commercial use.

CARE & MAINTENANCE:

STAIN RESISTANT CUSHIONS CARE: Keep cushions in storage on rainy days.

SPILLS: Immediately wipe up spills using a white damp cloth. Repeat if necessary until the stain is gone. Allow cushions to air dry.

FABRIC CARE: Hand wash cold, non-chlorine bleach when needed, lay flat to dry. Cool iron if necessary. Do not dry clean.

RESIN WICKER PRODUCT CARE:

General Cleaning: Before using, clean the product completely with a soft, dry towel. When not in use, wipe off any dirt or loose objects. Use a mild soap and water solution for regular cleaning, rinse thoroughly, and dry completely.















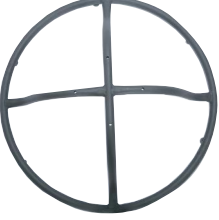







Weather Protection: To prolong the life of your resin wicker, avoid prolonged exposure to intense sunlight or heavy rain. Whenever possible, use a protective cover when the furniture is not in use, especially during extreme weather conditions.

Regular Maintenance: Over time, nuts and bolts may loosen. Occasionally check and re-tighten nuts and bolts on all chairs and tables if necessary.

Avoid Harsh Cleaners: Do not use strong detergents or abrasive cleaners, as these may damage the finish.

Warranty period: 180 days.

PARTS LIST

<p>A</p>  <p>2pcs</p>	<p>B</p>  <p>2pcs</p>	<p>C</p>  <p>2pcs</p>	<p>D</p>  <p>2pcs</p>
<p>E</p>  <p>2pcs</p>	<p>F</p>  <p>2pcs</p>	<p>G</p>  <p>2pcs</p>	<p>H</p>  <p>8pcs</p>
<p>I</p>  <p>1pc</p>	<p>J</p>  <p>1pc</p>	<p>K</p>  <p>4pcs</p>	<p>L</p>  <p>2pcs</p>
<p>M</p>  <p>2pcs</p>	<p>N</p>  <p>1pc</p>	<p>O</p>  <p>M6x15 12pcs</p>	<p>P</p>  <p>M6x35 16pcs</p>
<p>Q</p>  <p>M6x40 20pcs</p>	<p>R</p>  <p>M6x45 16pcs</p>	<p>S</p>  <p>96pcs</p>	<p>T</p>  <p>16pcs</p>
<p>U</p>  <p>32pcs</p>	<p>V</p>  <p>1pc</p>	<p>W</p>  <p>1pc</p>	<p>X</p>

ASSEMBLY

1

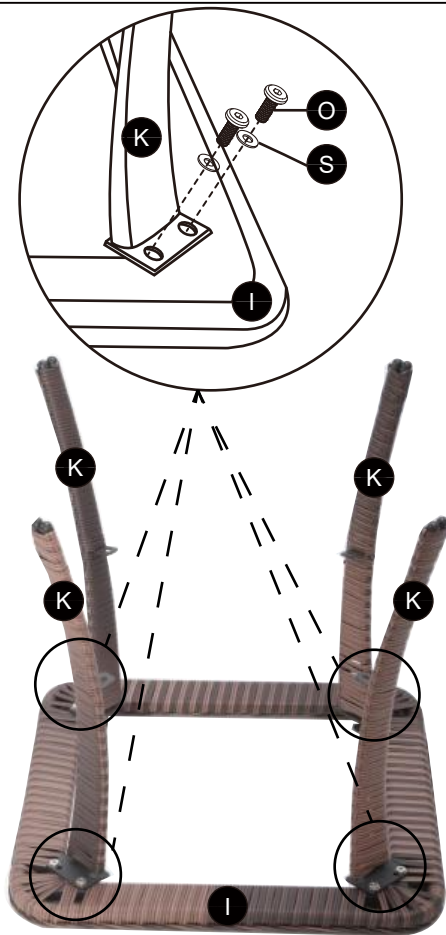

O:8pcs
S:8pcs

2

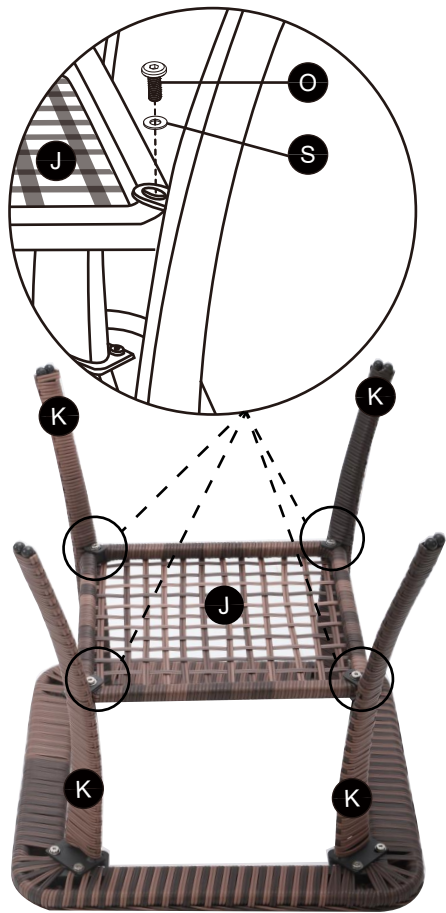

O:4pcs
S:4pcs

3



4

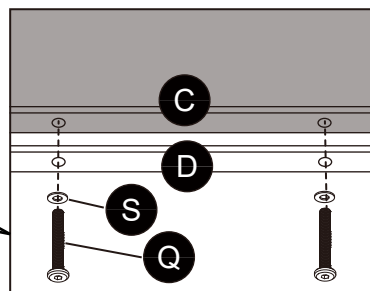
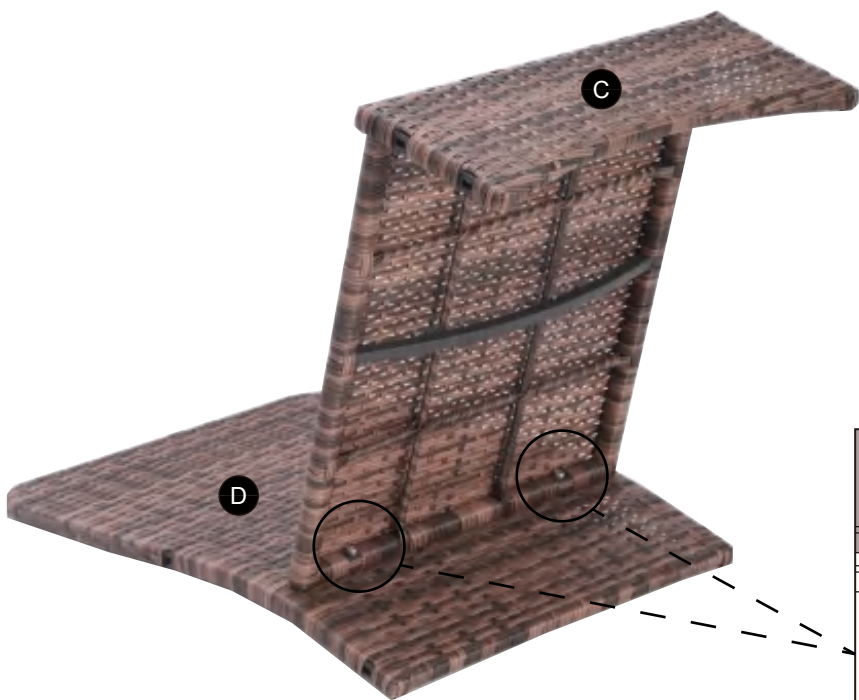

Q:2pcs x2
S:2pcs x2

5

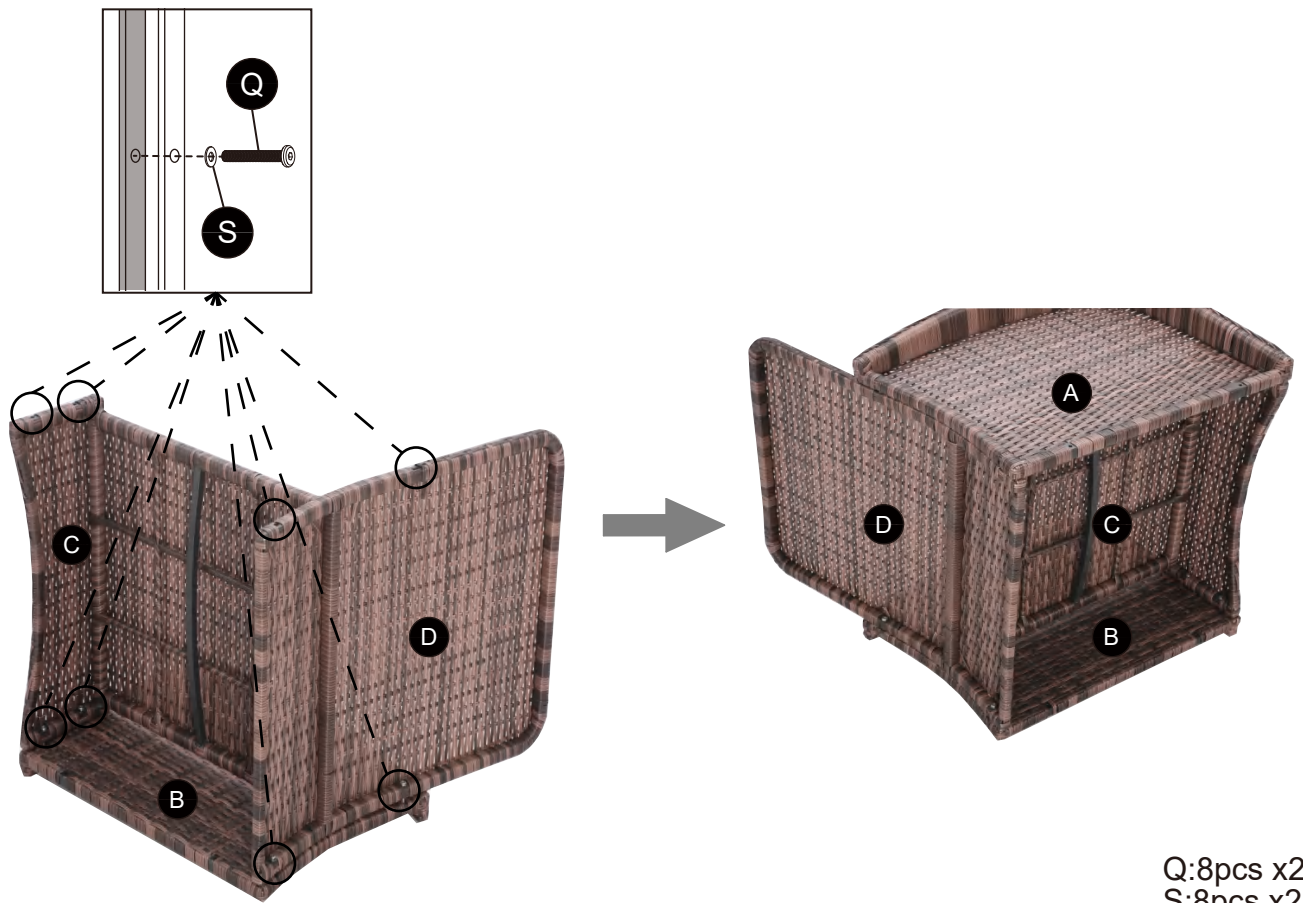

Q:8pcs x2
S:8pcs x2

6

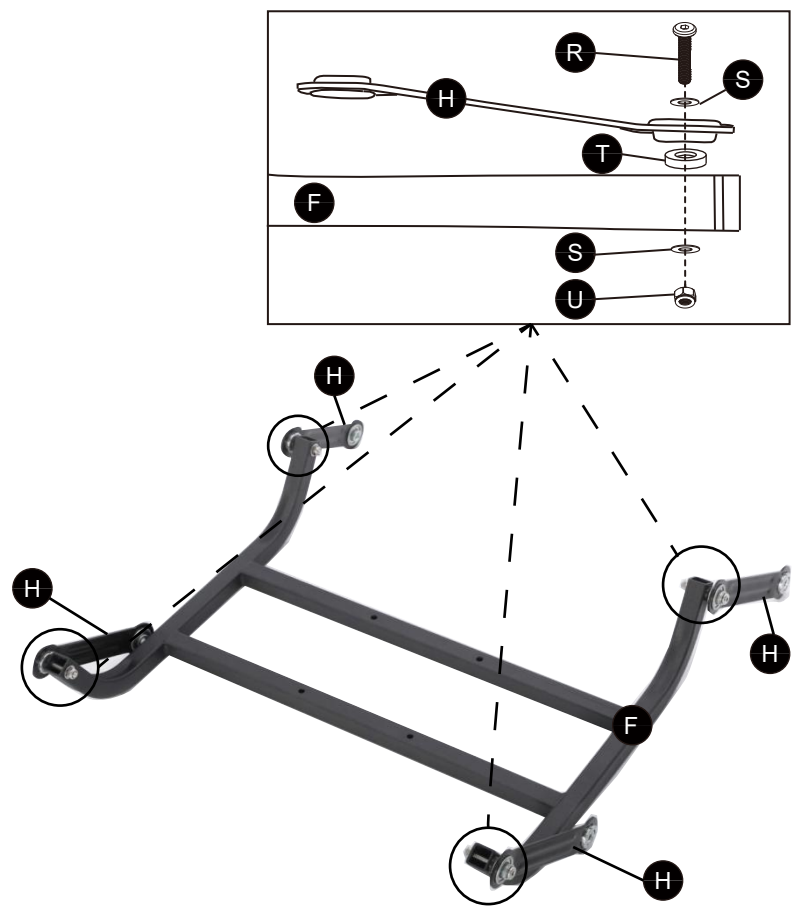

R:4pcs x2
S:8pcs x2
T:4pcs x2
U:4pcs x2

7

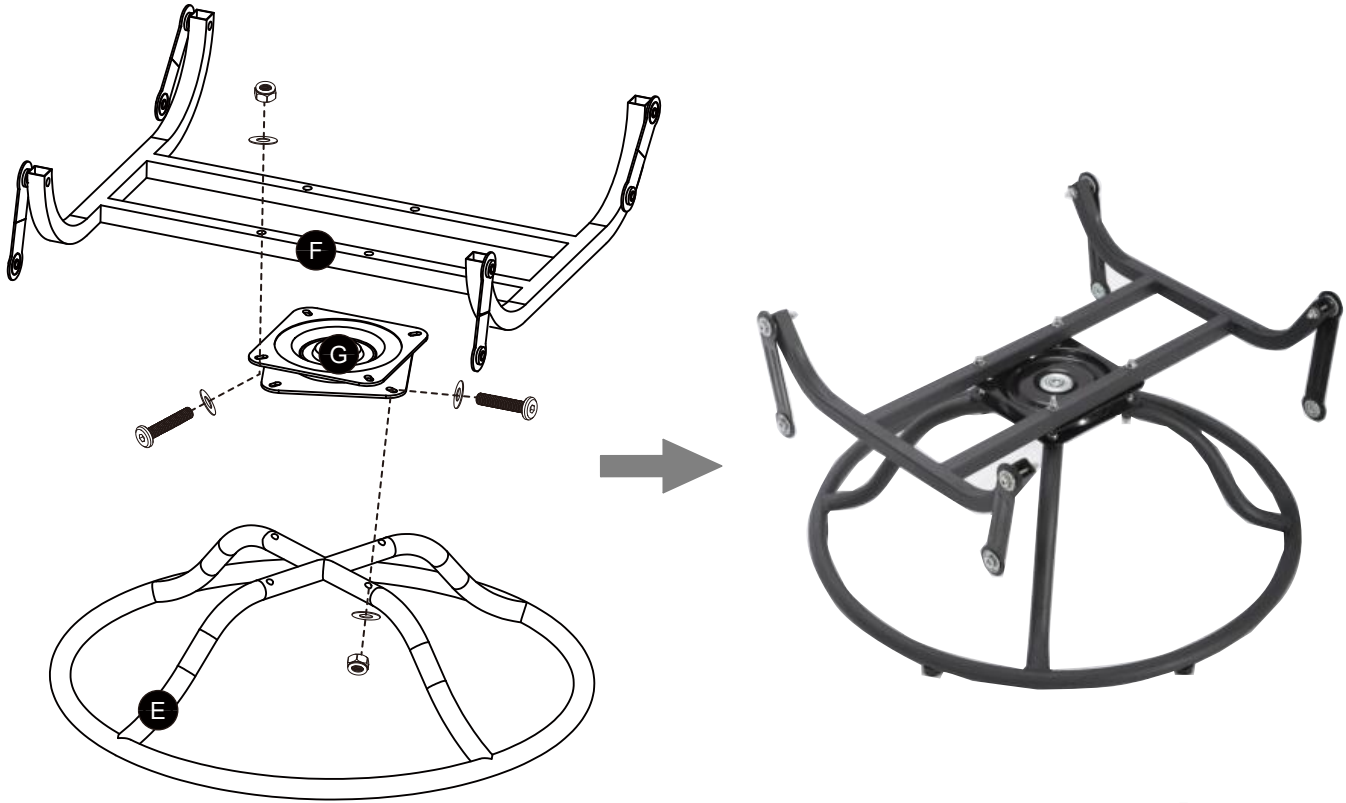

P:8pcs x2
 S:16pcs x2
 U:8pcs x2

8

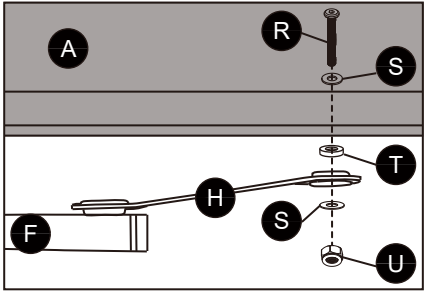
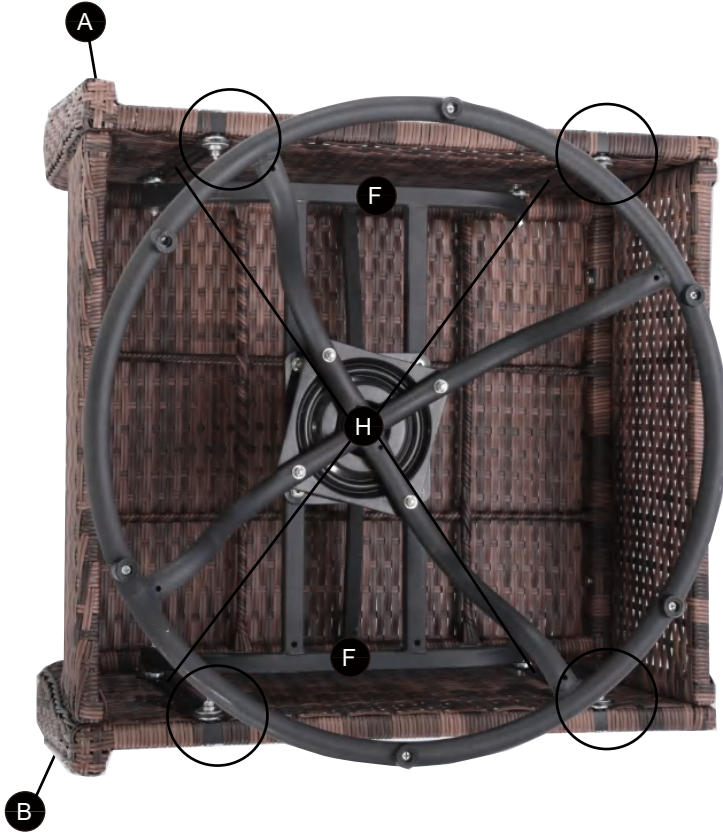

R:4pcs x2
 S:8pcs x2
 T:4pcs x2
 U:4pcs x2

