

Instruction Manual

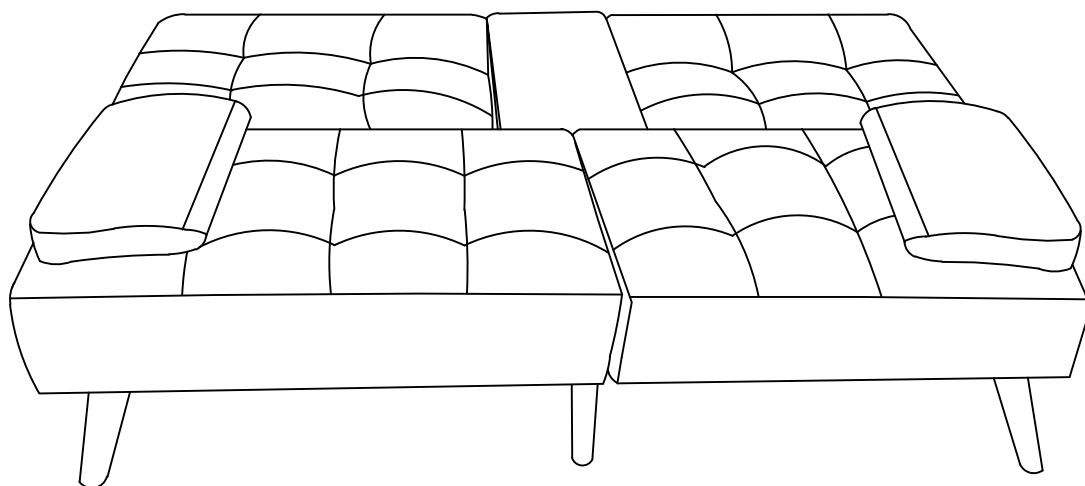

Thank you for shopping with us!





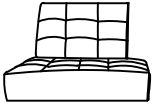
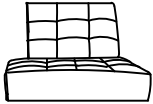
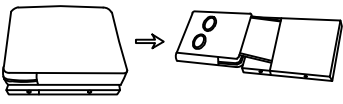
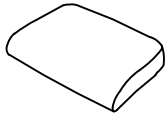

If any parts is missing, broken upon receipt or you need any help from us. For the FASTEST solutions, please FIRSTLY CONTACT US

Accessories list

Note: All the parts or hardware marked with*are tucked under seat frame

A  Left seat frame	B  Right seat frame	C  Coffee Table Board(1)	D  Armrest bag(2)
--	---	---	---

Hardware list

E *  M5x95x35Wrench(1)	F *  16mmGasket (4)	G *  6x22Screw(4)	H *  70x25x3 Foot plate(2)
I *  Middle foot of sofa(4)	J *  Sofa foot(2)	K *  8*50Screw(6)	

Step 1:

Get all the hidden parts out of A and B

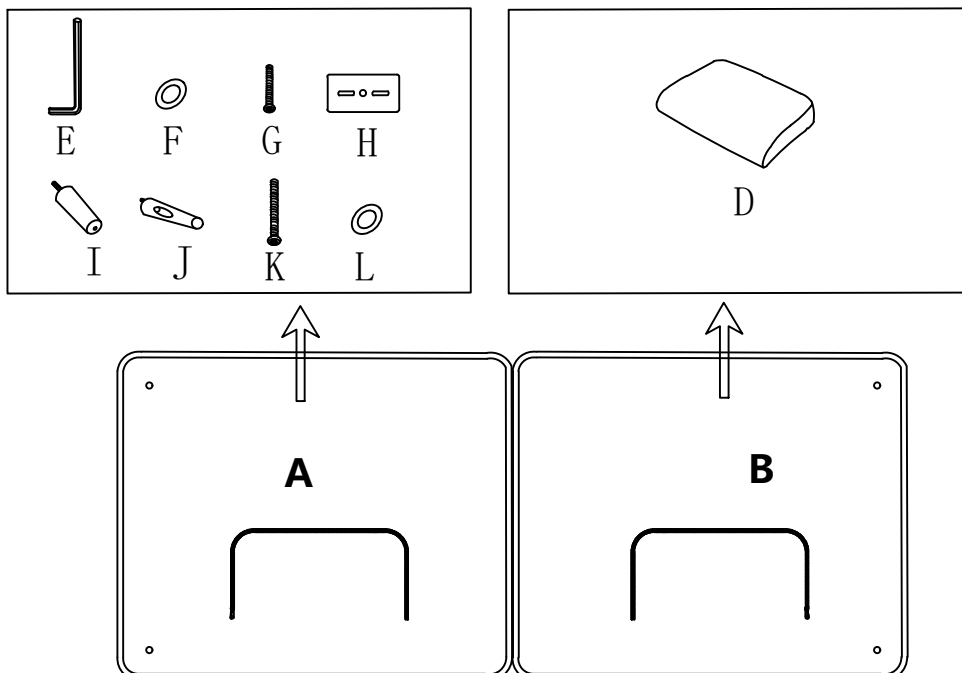

STEP 2:

Install the sofa leg J into the hole at the lower left corner of the seat frame A, and then install the sofa foot I into the hole at the upper left corner of the seat frame A

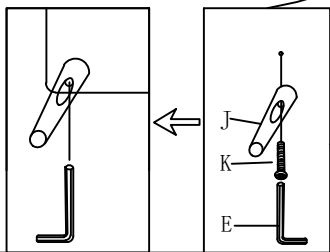
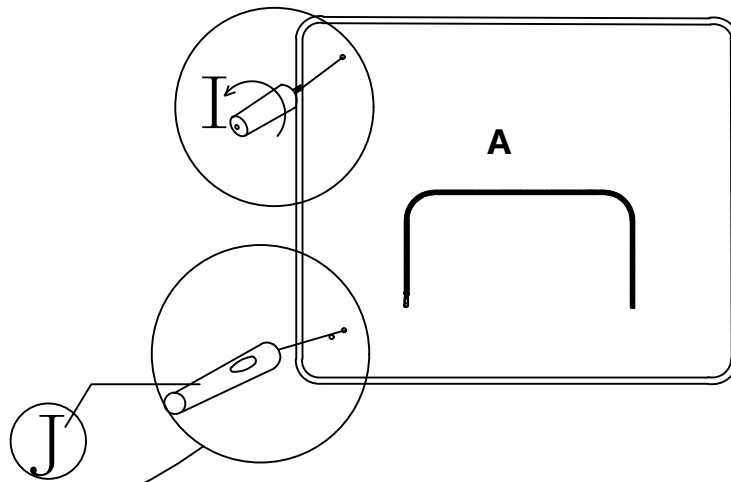

STEP 3:

Install the sofa leg J into the hole at the lower right corner of the seat frame B, and then install the sofa foot I into the hole at the upper right corner of the seat frame B

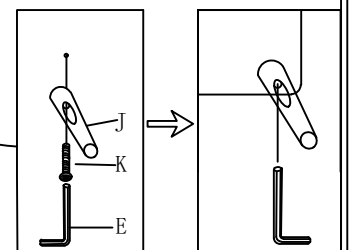
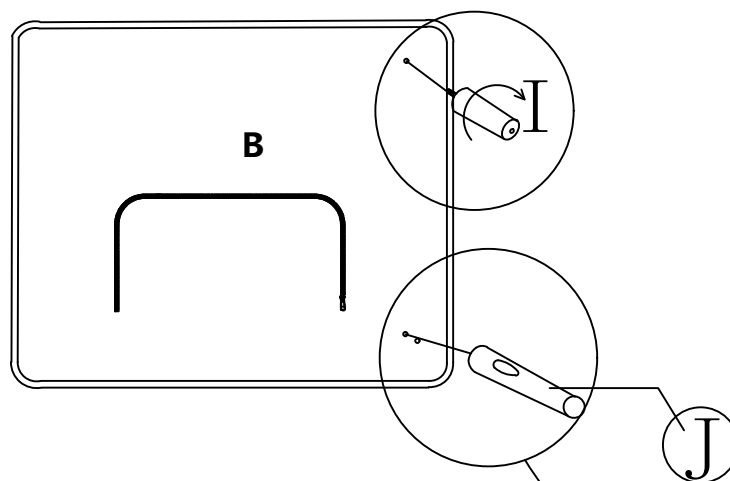

STEP 4:

Connect the upper and lower two holes of the A and B seat frames without sofa legs with an iron sheet H and a screw G, and then install the sofa legs I onto the iron sheet H

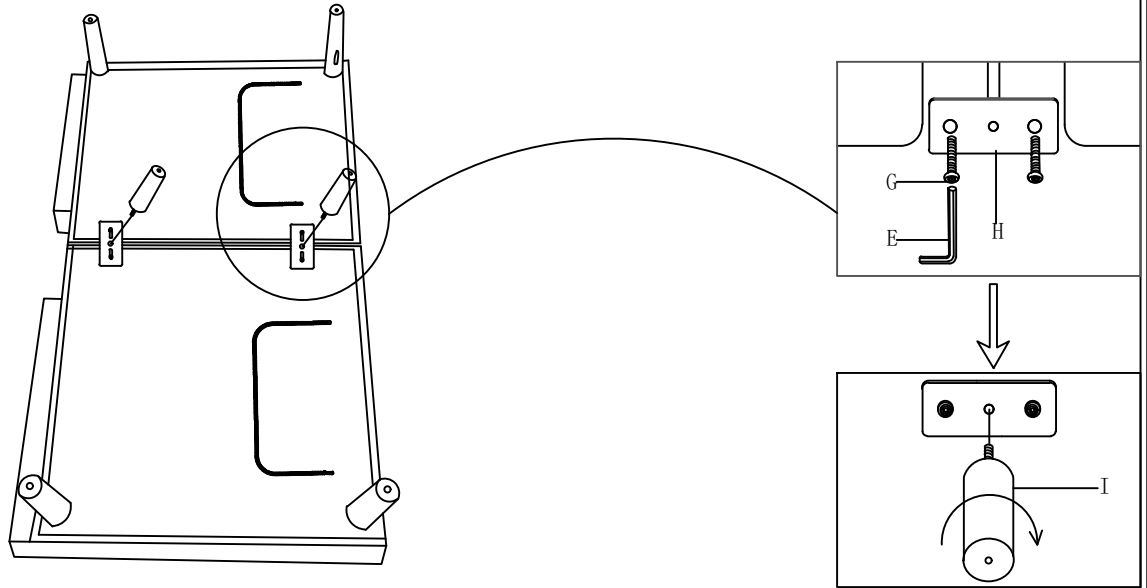

STEP 5:

Lift up the backrest and insert the coffee table. Fix with screws and stick on Velcr

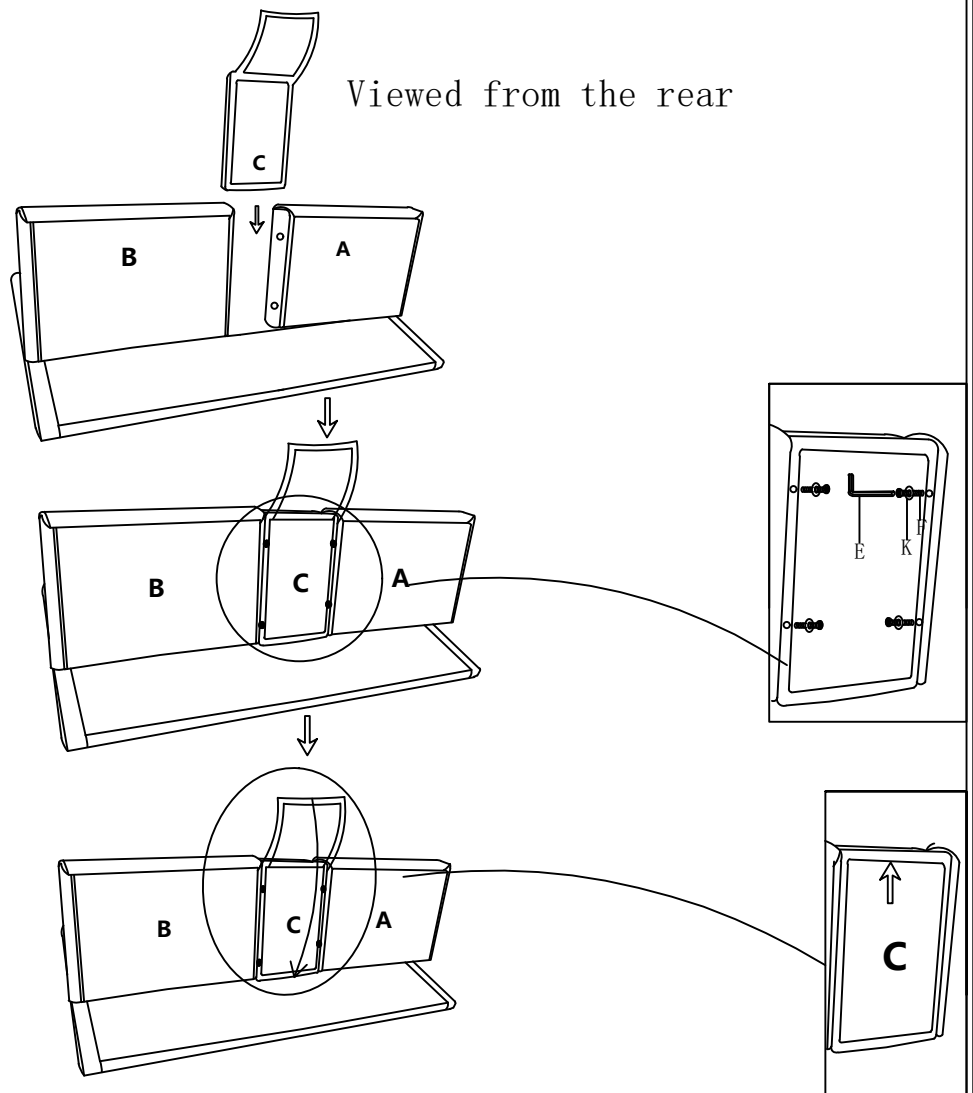

STEP 6:

Put the armrest bag on the sofa

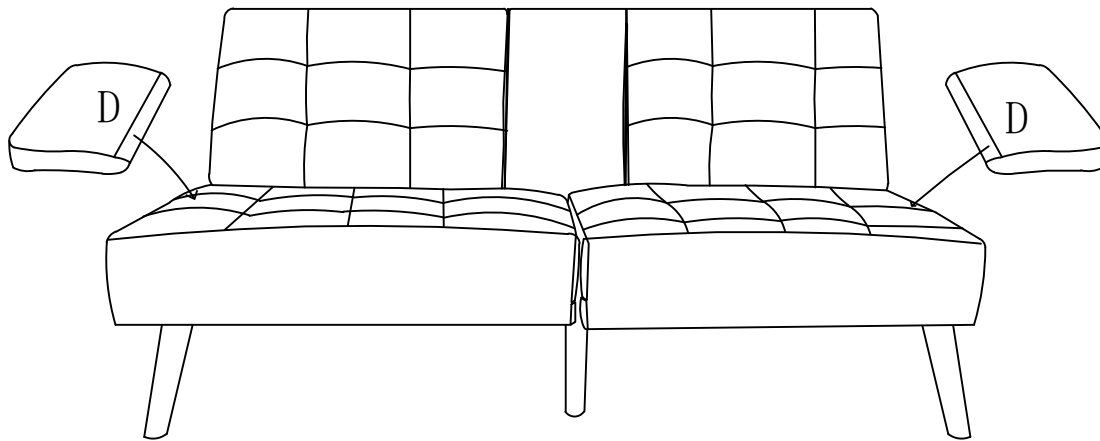

STEP 7:

Put down the coffee table and the assembly is finished

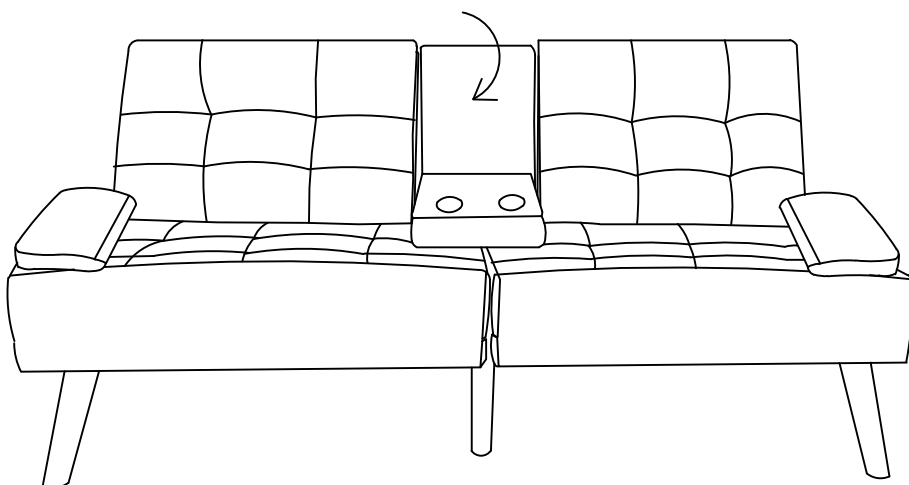

STEP 8:

The backrest is adjustable for three angles

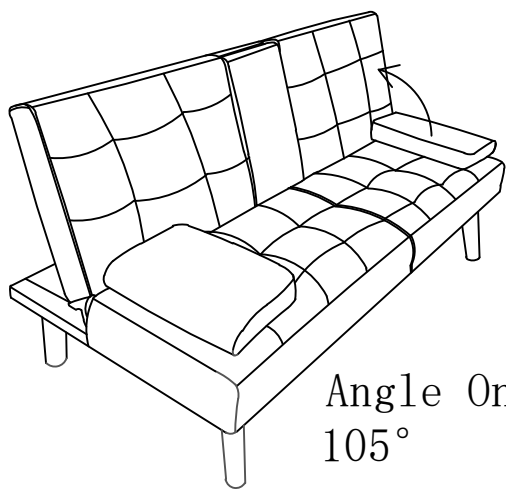

Angle One
105°

Tip:

Pull the backrest forward till you hear the snap sound and push it backwards slowly to the angle you want.

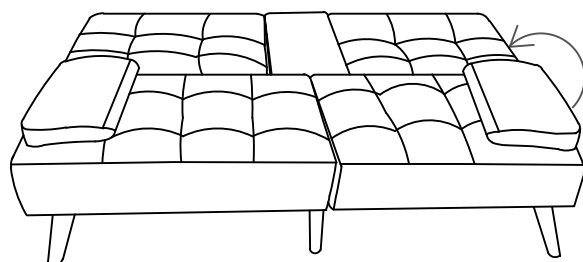

Angle Three
180°

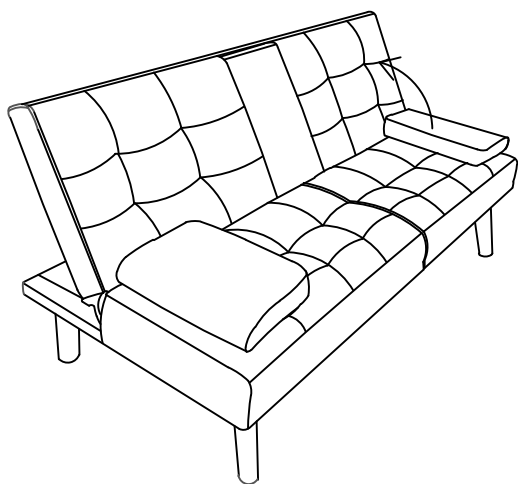

Angle Two
135°