

ASSEMBLY INSTRUCTION

ITEM NO.N715P195561

Console Table



ASSEMBLY INSTRUCTION

ITEM NO.N715P195561

Please read these instructions fully before starting assembly:

1. Place all wooden parts on a clean and smooth surface such as a rug or carpet to avoid scratching the parts.
2. Kindly follow the assembly instructions step by step.
3. Do not tighten all screws and bolts until the table is fully assembled.
4. Unscrew the protective plastique supports from the metal insert of the table legs before assembly.
5. Parts of the assembly will be easier with 2 people.

Care and maintenance:

Only clean using a damp cloth and mild detergent, do not use bleach or abrasive cleaners.

ASSEMBLY INSTRUCTION

ITEM NO.N715P195561

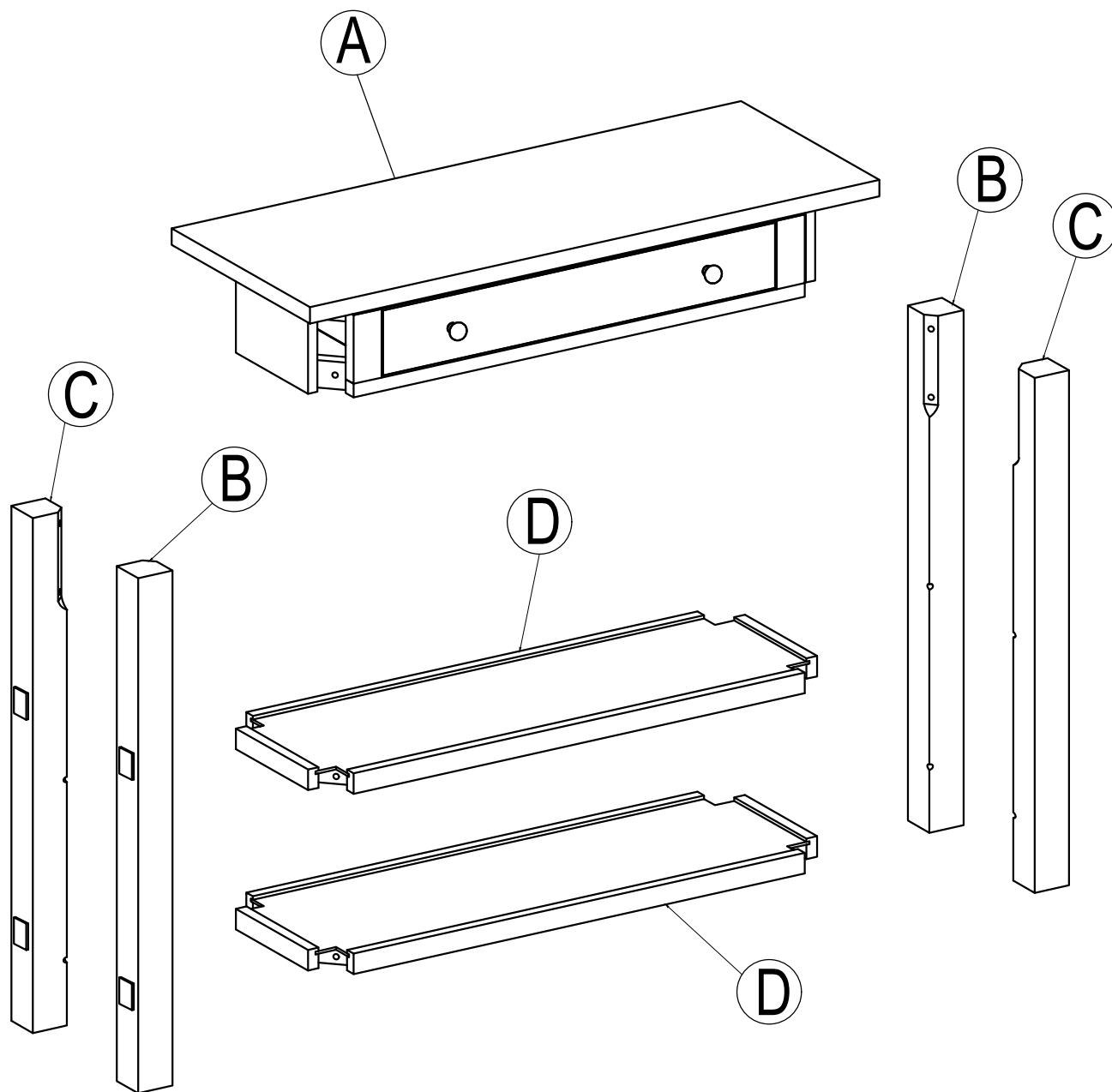

ASSEMBLY INSTRUCTION

ITEM NO.N715P195561

Part List

(A)

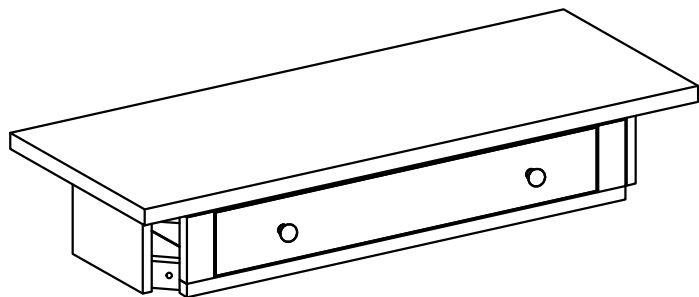
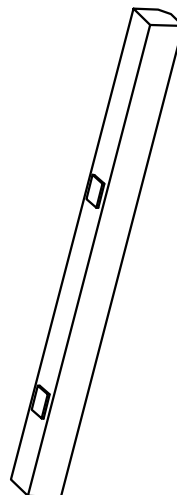

TABLE TOP (1 pc)

(B)



LEG LEFT (2 pcs)

(C)

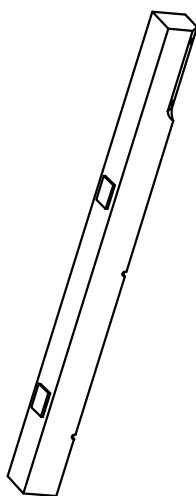

LEG RIGHT (2 pcs)

(D)

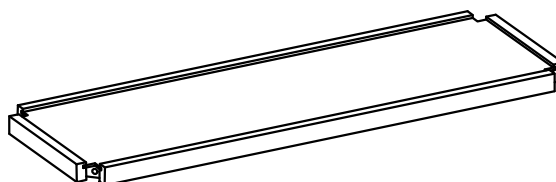

SHELF PANEL (2 pcs)

ASSEMBLY INSTRUCTION

ITEM NO.N715P195561

Hardware List

①

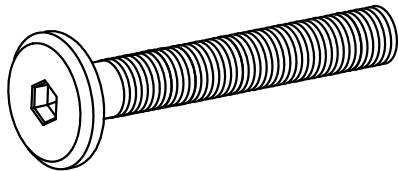

Ø 5/16" x 55 mm

BOLT (16 pcs)

②

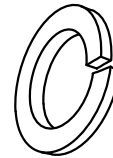

Ø5/16" x 13 mm

FLAT WASHER (16 pcs)

③

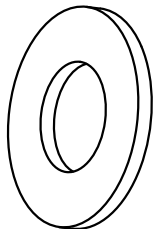

Ø5/16" x 19 mm

LOCK WASHER (16 pcs)

④

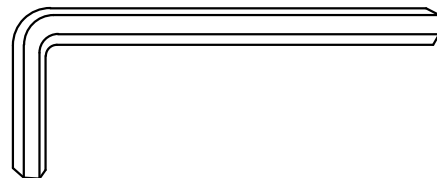

4 mm

ALLEN KEY (1 pc)

⑤

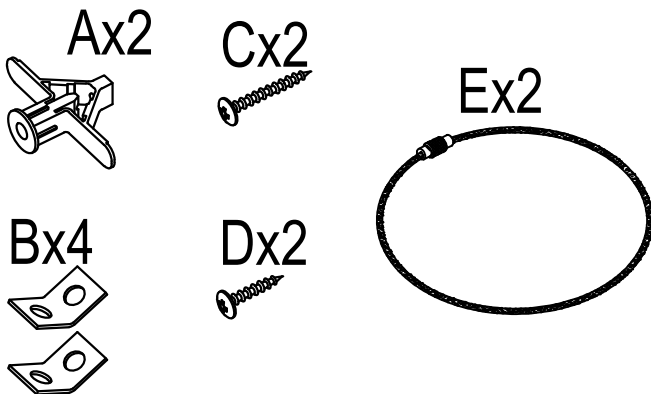





ANTI-PARKING KIT (2 sets)

ASSEMBLY INSTRUCTION

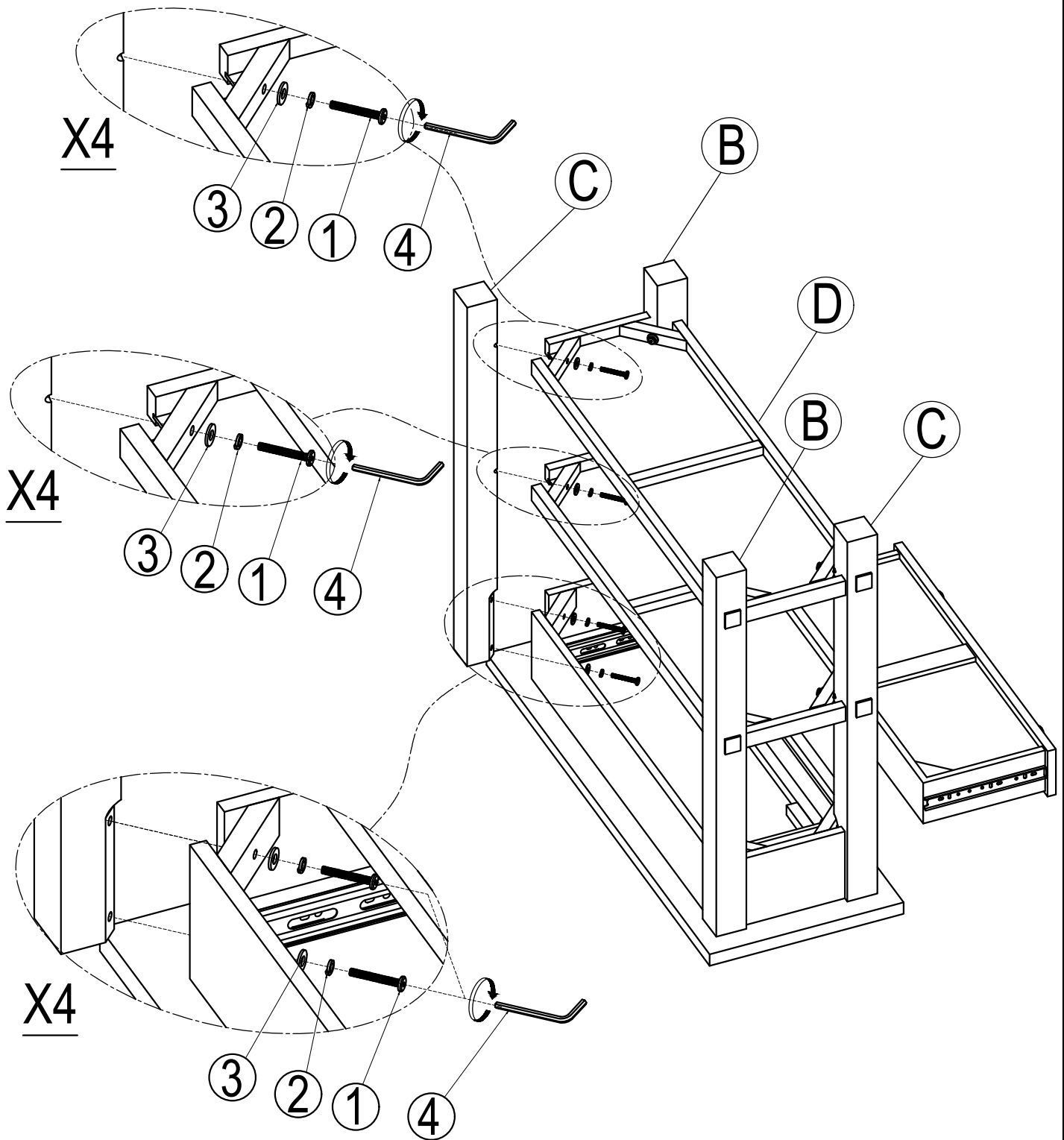
ITEM NO.N715P195561

STEP 1:



BOLT Ø 5/16" x 55 mm	FLAT WASHER Ø5/16" x 13 mm	LOCK WASHER Ø5/16" x 19mm	ALLEN KEY 4 mm
			
①x 16	②x 16	③x 16	④x 1





ASSEMBLY INSTRUCTION

ITEM NO.N715P195561

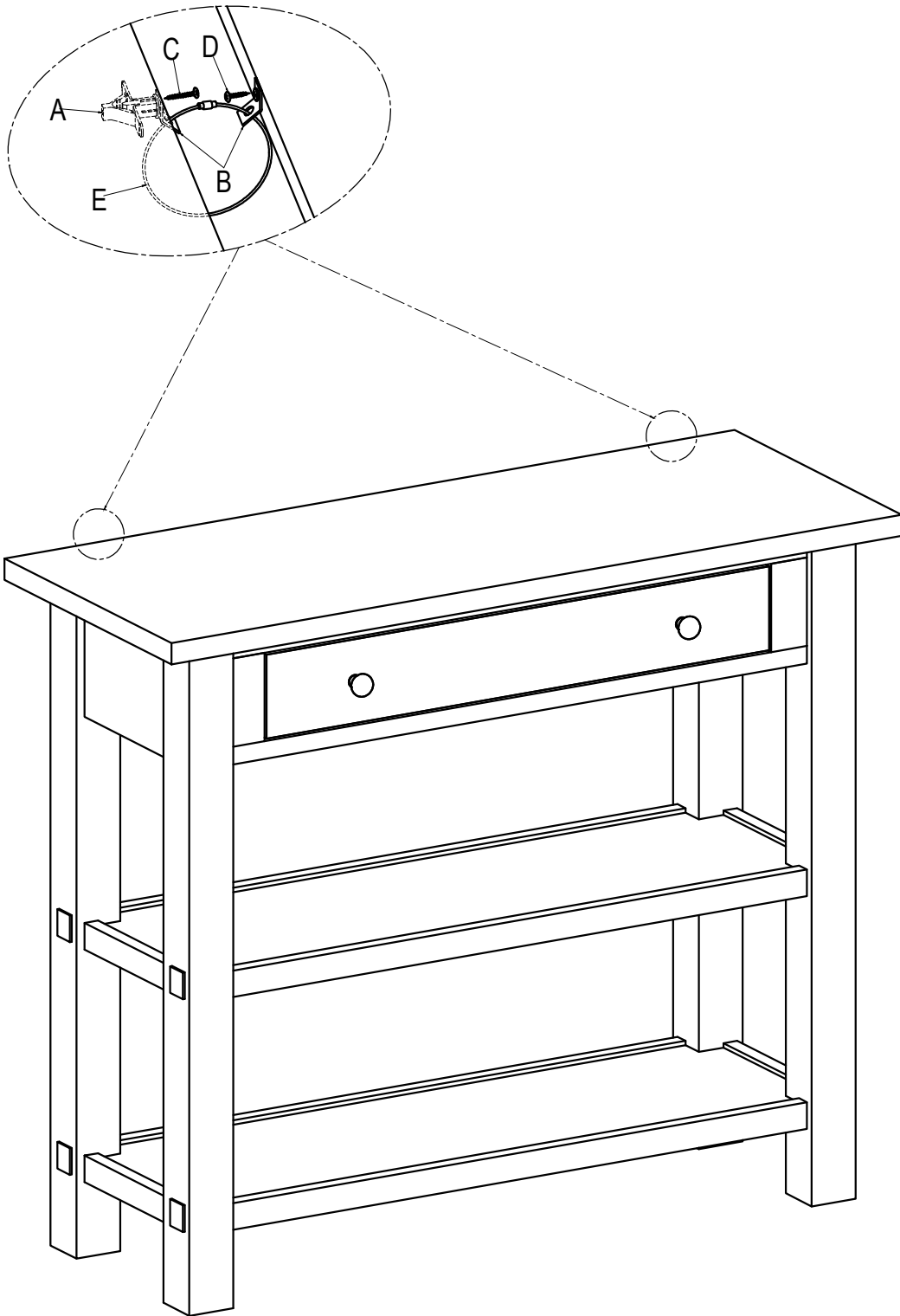
STEP 2:

X2



 2 pcs	 4 pcs	 2 pcs	 2 pcs	 2 pcs
---	--	--	--	--

COMPLETE