

# ASSEMBLY INSTRUCTIONS

HYDS-016-HT

HYDS-016-HS

HYDS-016-YM

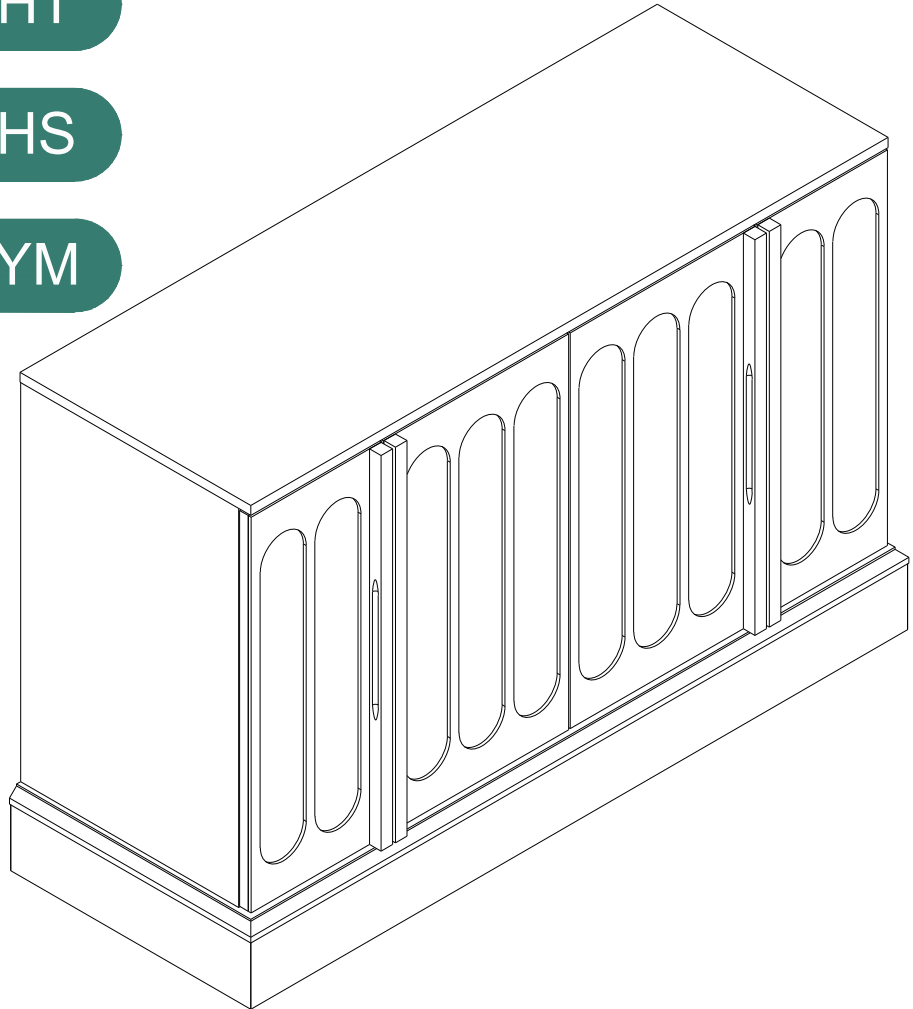

## Notice:

1. Follow the installation instructions. Please confirm all accessories are preset before installation.
2. Do not fully tighten the screws during initial assembly. Fully tighten screws only once all pieces which are correctly assembled.
3. If you encounter any problems during installation, please contact our customer service.
4. Please unbox the item from the side with an open-label and put a carpet on the floor to avoid scratching it.

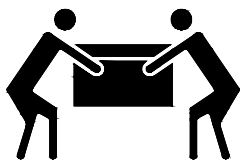

Recommended installers:2

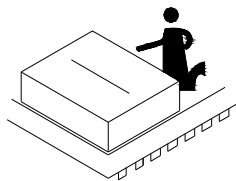

Put a carpet on the floor  
before unpacking

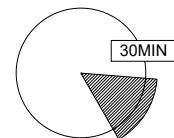

Estimate installation time:  
30minutes





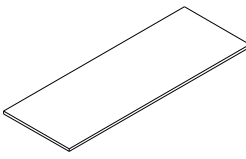
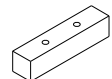
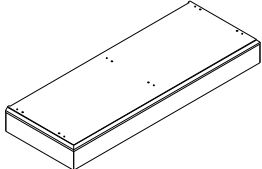
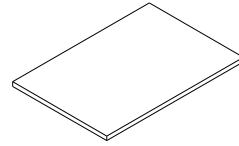
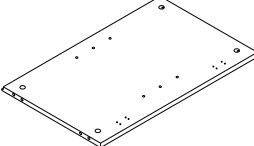
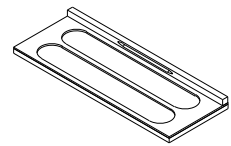
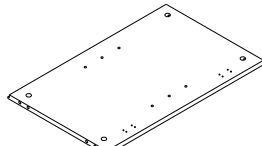
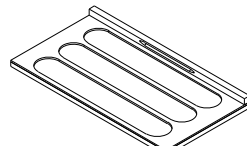
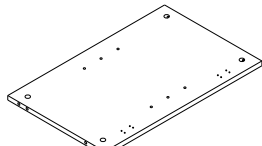
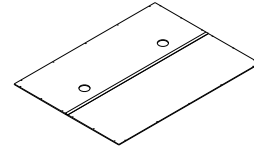

# ASSEMBLY INSTRUCTIONS

## PART LIST

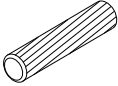
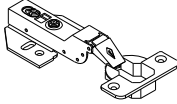
Item no.	Reference Image	Qty		Item no.	Reference Image	Qty
Ⓐ		X1		Ⓕ		X2
Ⓑ		X1		Ⓖ		X2
Ⓒ		X1		Ⓖ		X2
Ⓓ		X1		Ⓖ		X2
Ⓔ		X1		Ⓖ		X1

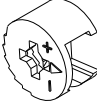
# ASSEMBLY INSTRUCTIONS

## HARDWARE LIST

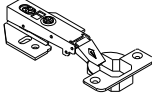
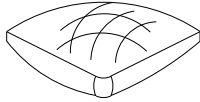
Item no.	Reference Image	Qty	Item no.	Reference Image	Qty
1	 Ø8*30mm	X12+1	6		X4
2		X12+1	7	 Ø3*14mm	X48+4
3		X12+1	8	 Ø3*15mm	X22+2
4	 Ø4*25mm	X4	9		X8
5		X4	10		X2

# ASSEMBLY INSTRUCTIONS

---

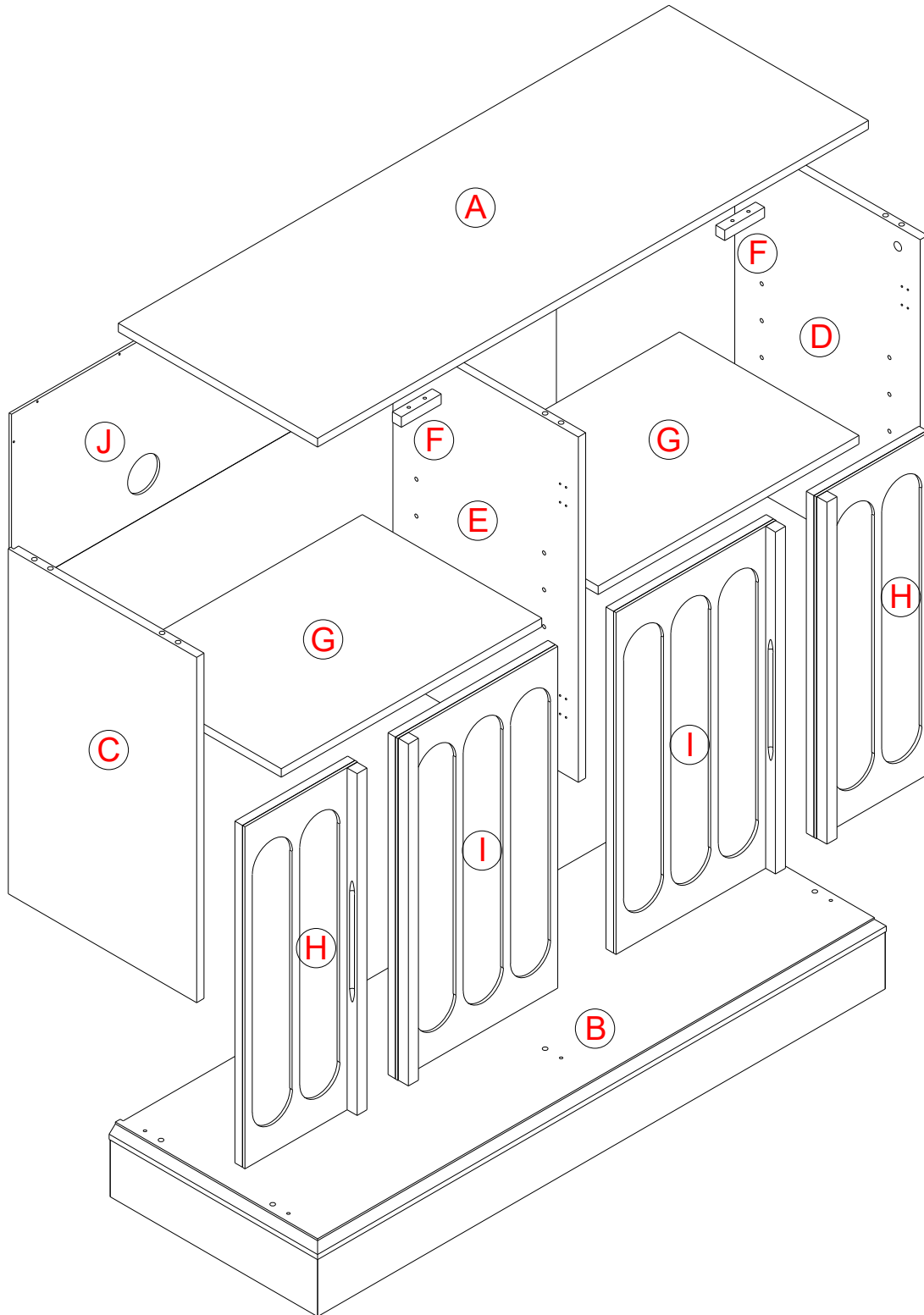

# ASSEMBLY INSTRUCTIONS

1

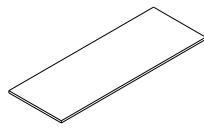

(A) 1PC

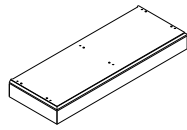

(B) 1PC

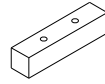

(F) 2PC



Ø4\*25mm

(4) 4PCS



(2) 12PCS

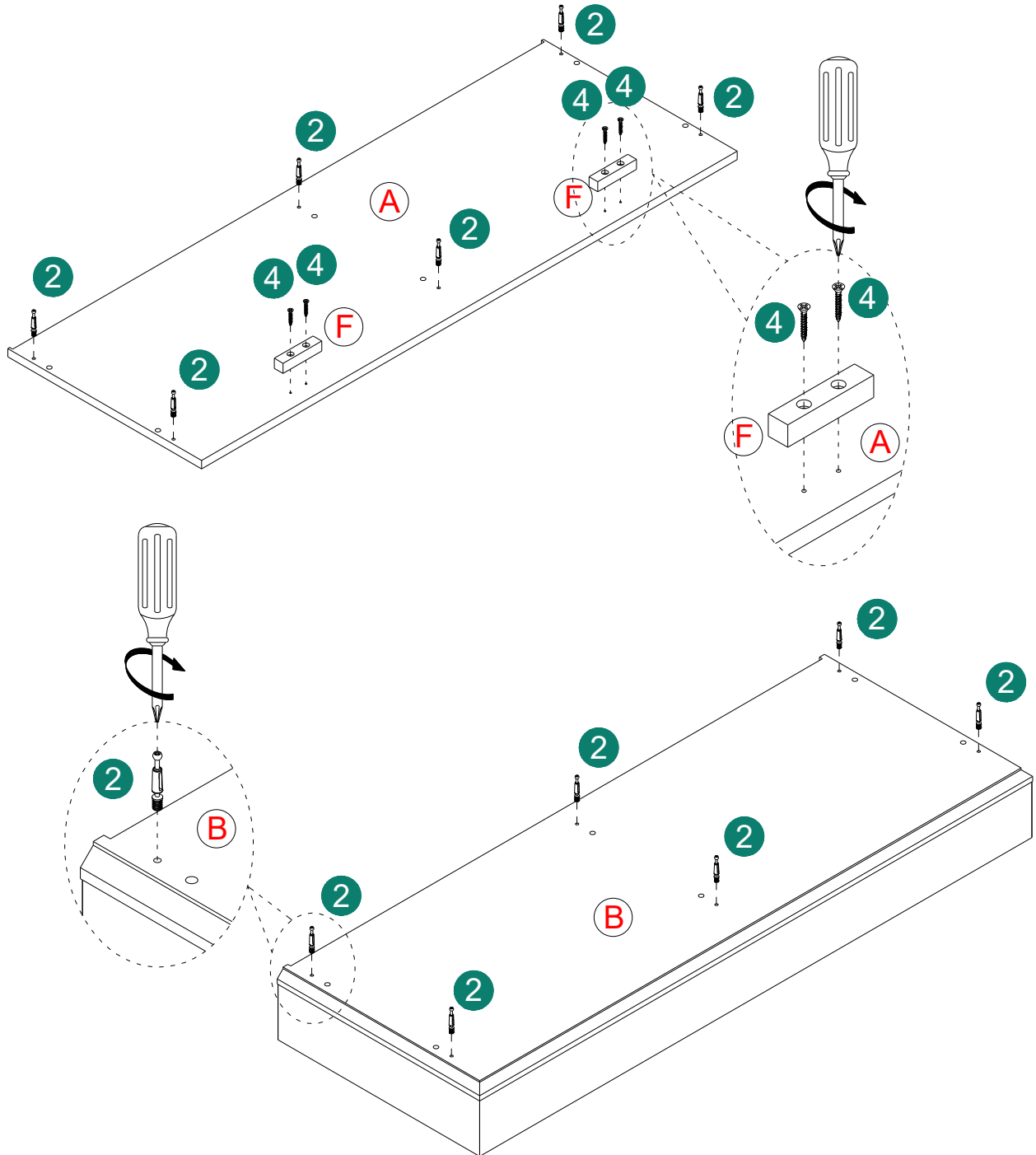

5

# ASSEMBLY INSTRUCTIONS

2

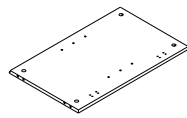

C 1PC

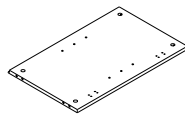

D 1PC

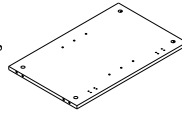

E 1PC

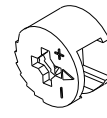

3 12PCS

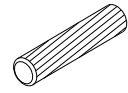

1 12PCS

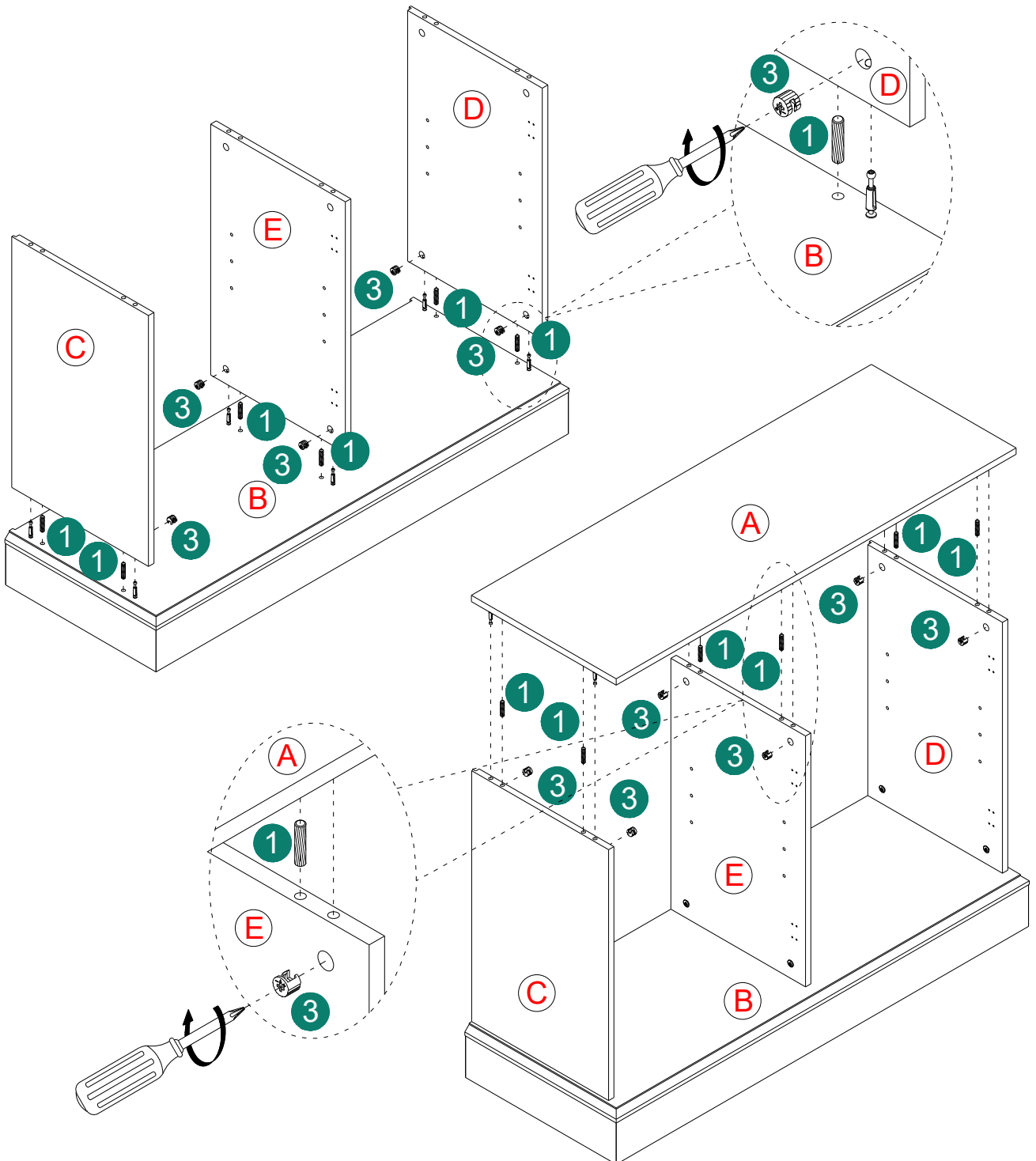

6

# ASSEMBLY INSTRUCTIONS

3

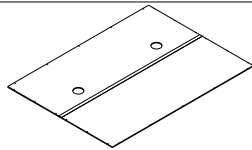

J 1PC

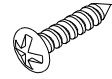

Ø3\*15mm  
8 22PCS

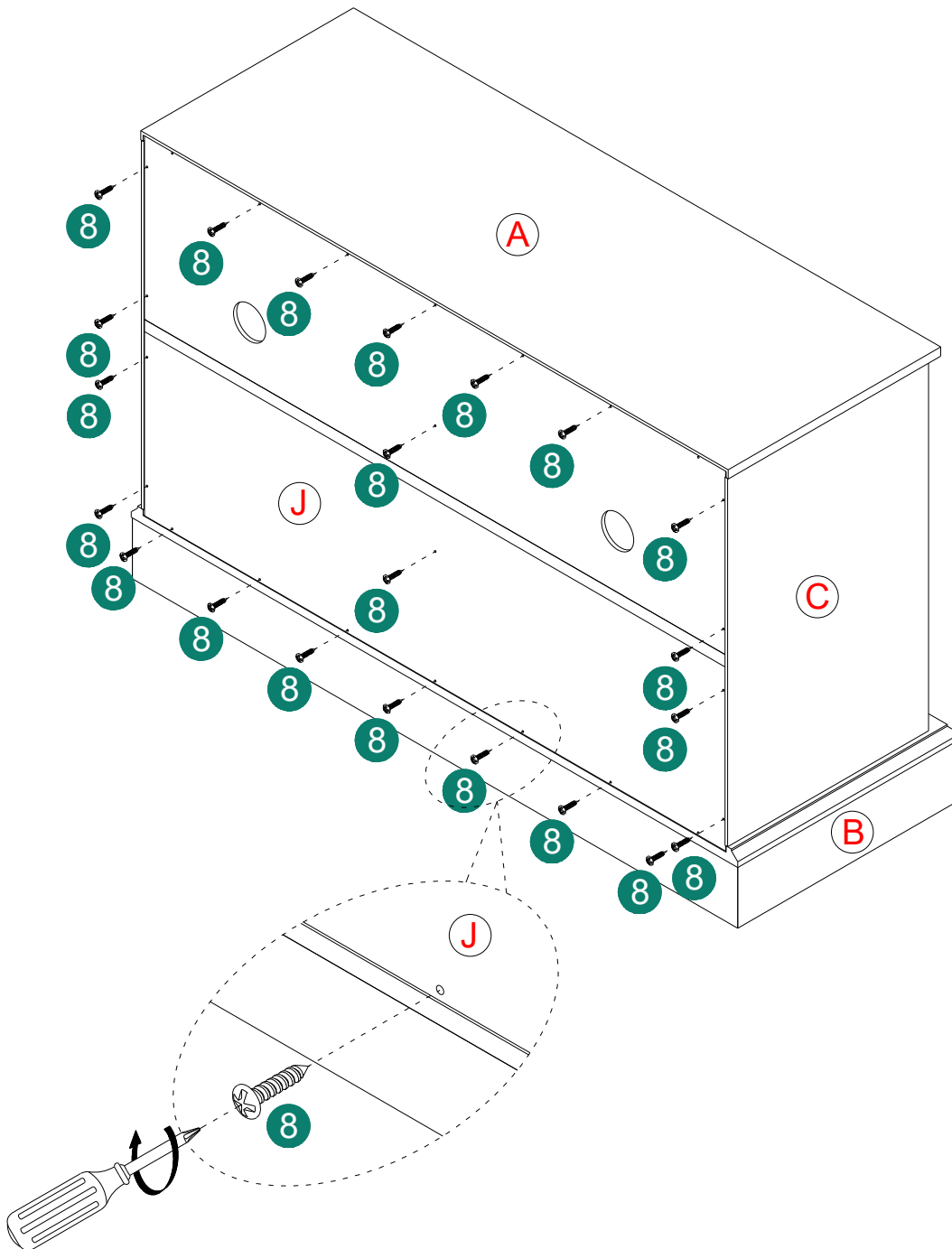

# ASSEMBLY INSTRUCTIONS

4

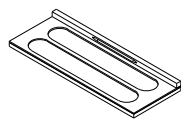

(H) 2PC

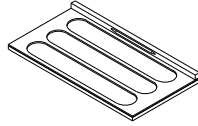

(I) 2PC

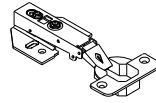

(5) 4PCS

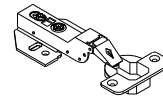

(6) 4PCS



Ø3\*14mm

(7) 16PCS

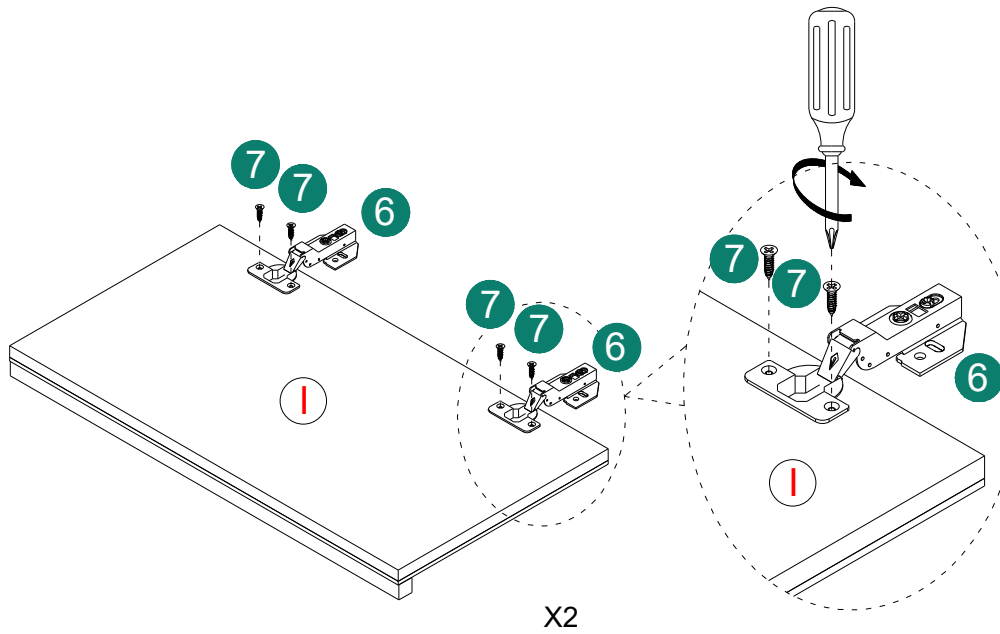
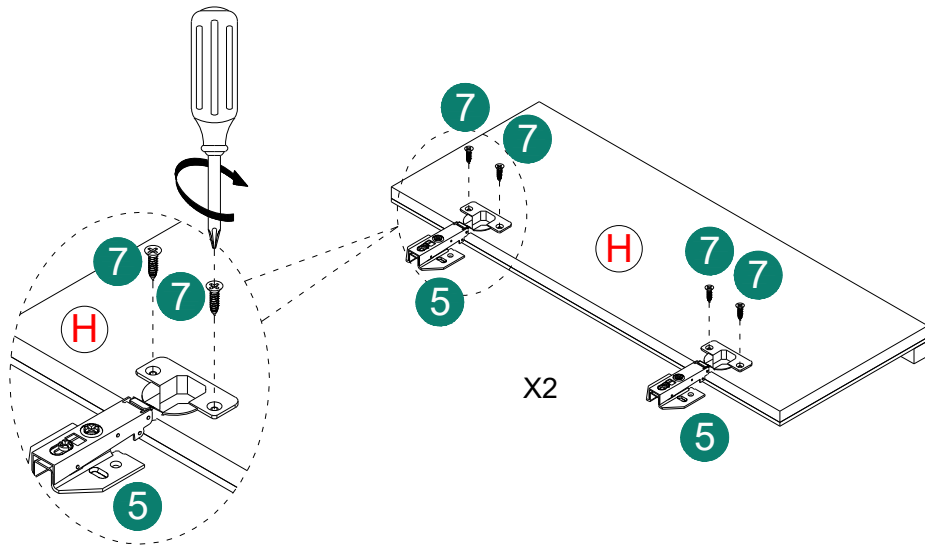

# ASSEMBLY INSTRUCTIONS

5

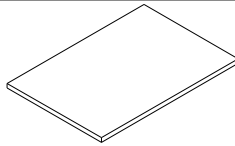

G 2PC



9 8PCS

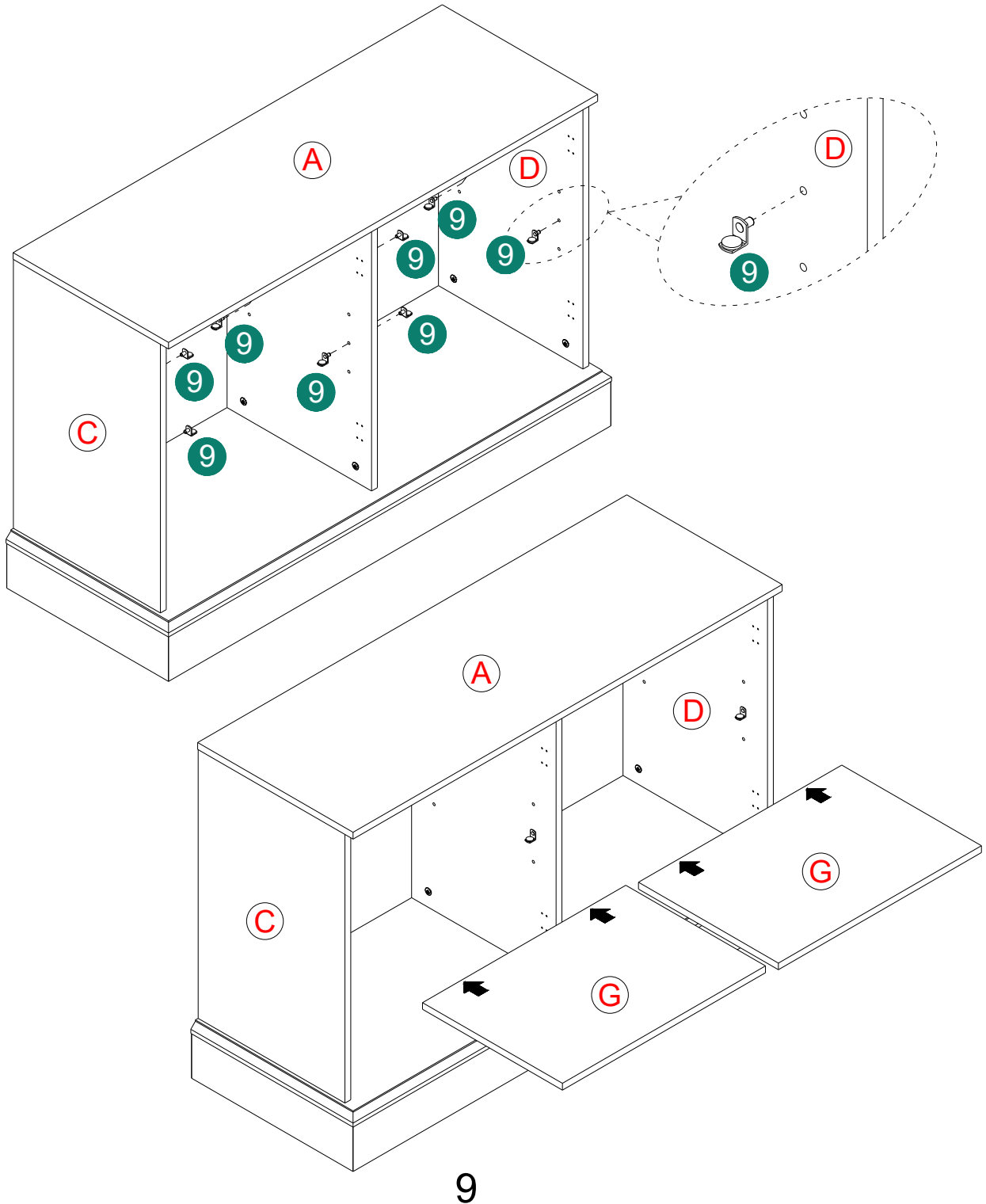

# ASSEMBLY INSTRUCTIONS

6

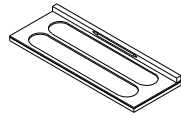

(H) 2PC

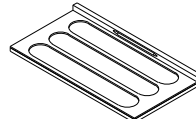

(I) 2PC



Ø3\*14mm

(7) 32PCS

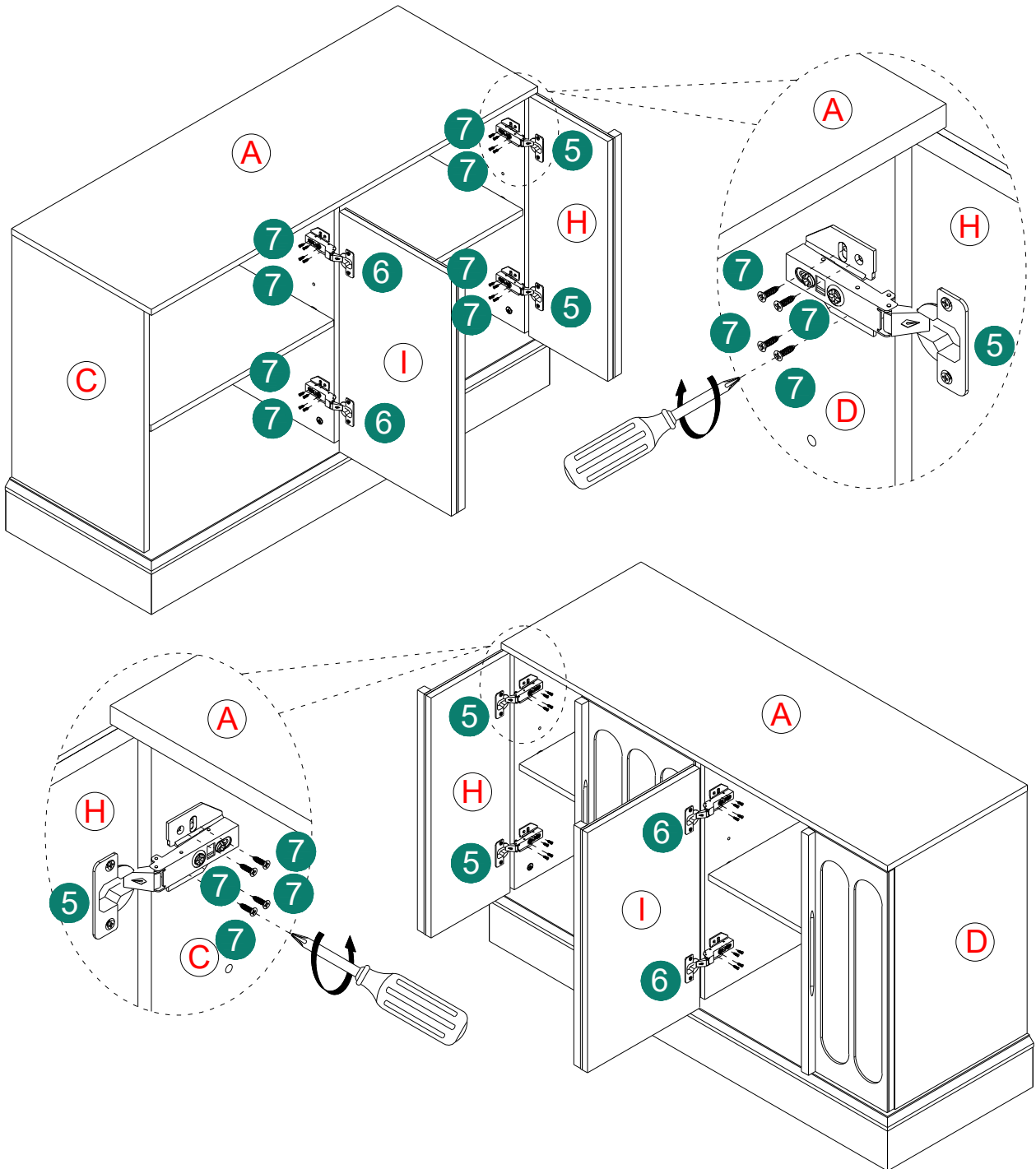

# ASSEMBLY INSTRUCTIONS

7

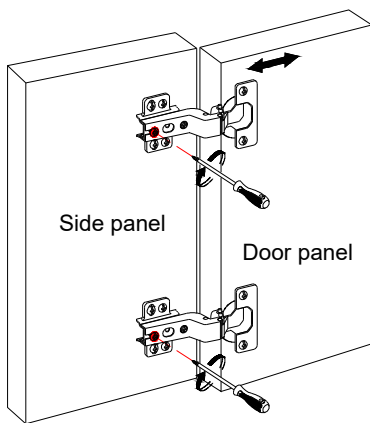

①

## Front-to-Back Direction Adjustment:

Rotate the screws on the door hinges shown in the image. The door panel can be moved front-back.

Adjustment range: 4mm

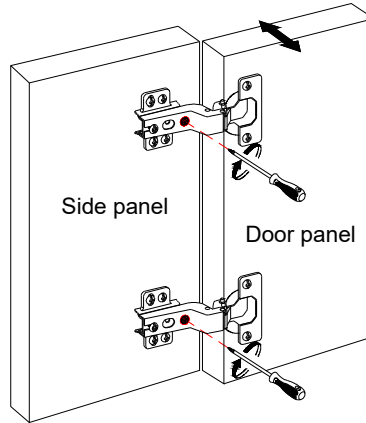

②

## Left-Right Direction Adjustment:

Rotate the screws on the door hinges shown in the image. The door panel can be moved left-right.

Adjustment range: 3mm

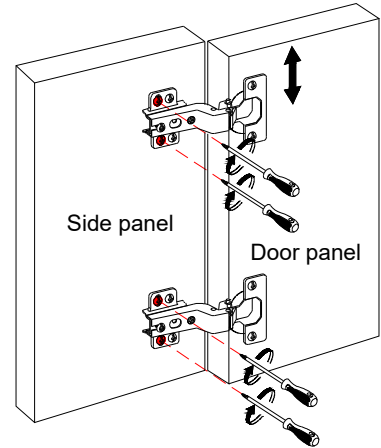

③

## Up-Down Direction Adjustment:

Rotate the screws on the door hinges shown in the image. The door panel can be moved up-down.

Adjustment range: 4mm

# ASSEMBLY INSTRUCTIONS

8

## Common Door Panel Issues:

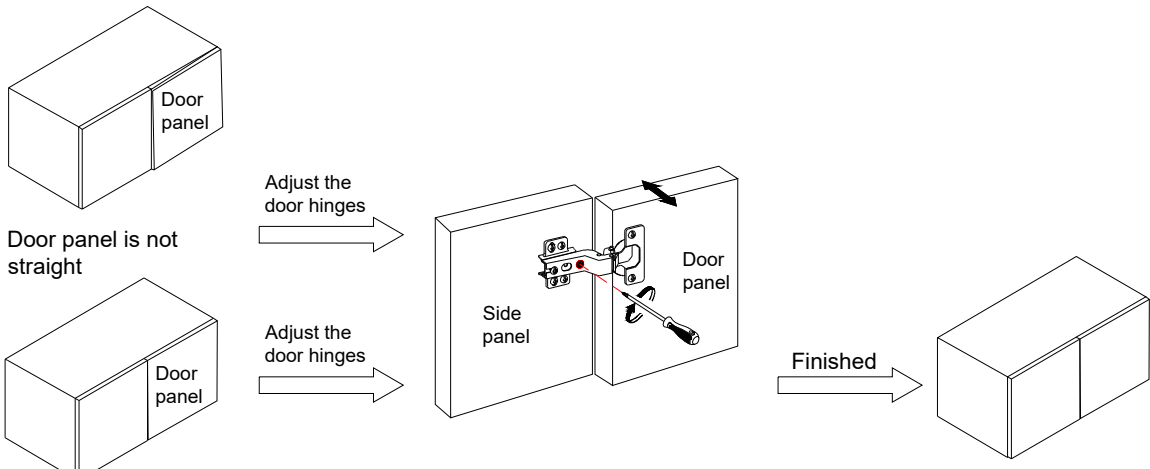

The gap between door panels is too large

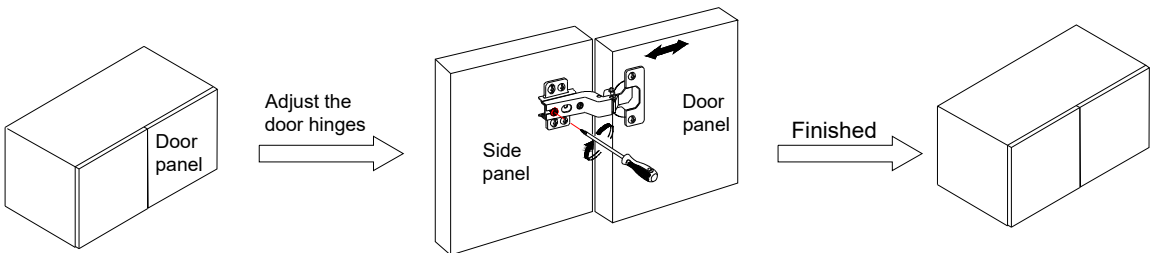

The door panels are not coplanar

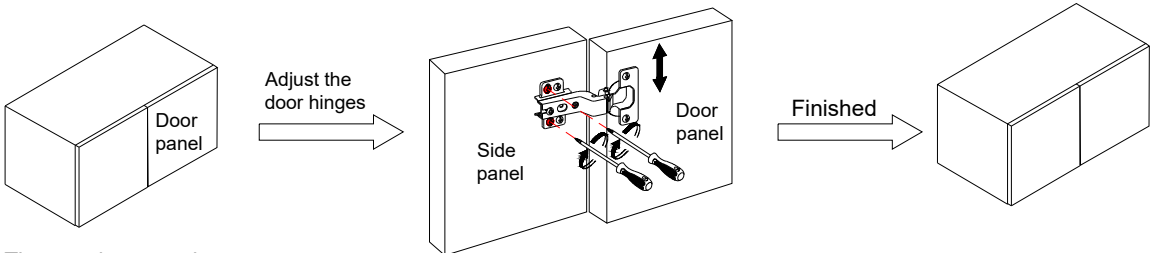

The two door panels are not at the same height

# ASSEMBLY INSTRUCTIONS

9

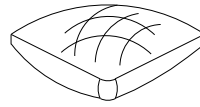

10 2set

A

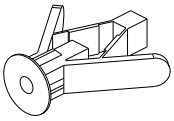

2pcs

B

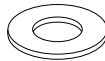

4pcs

C

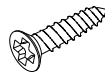

Ø8\*3/4"  
2pcs

D

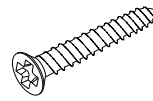

Ø8\*1-1/2"  
2pcs

E

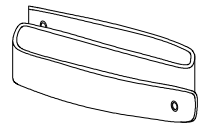

2pcs

