

DINING CHAIRS

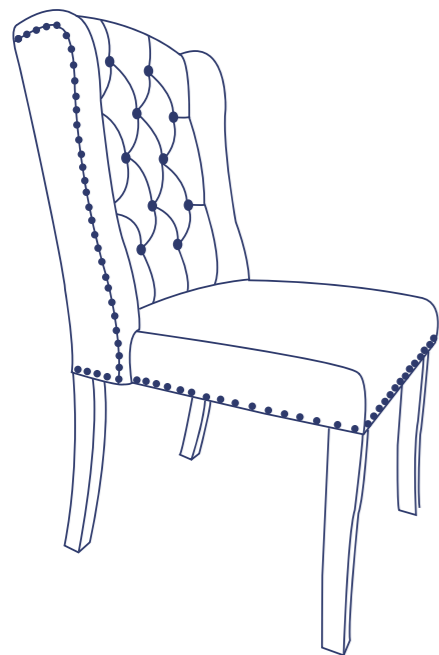

PARTS LIST

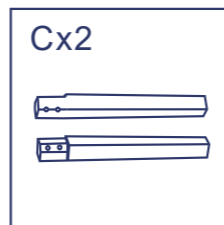
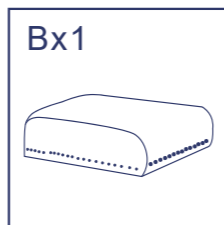
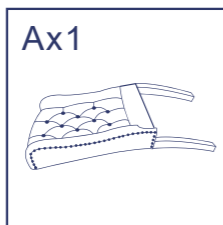

HARDWARE LIST

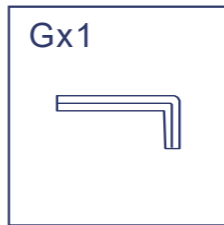
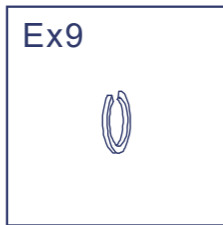
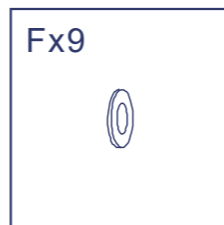

STEP1

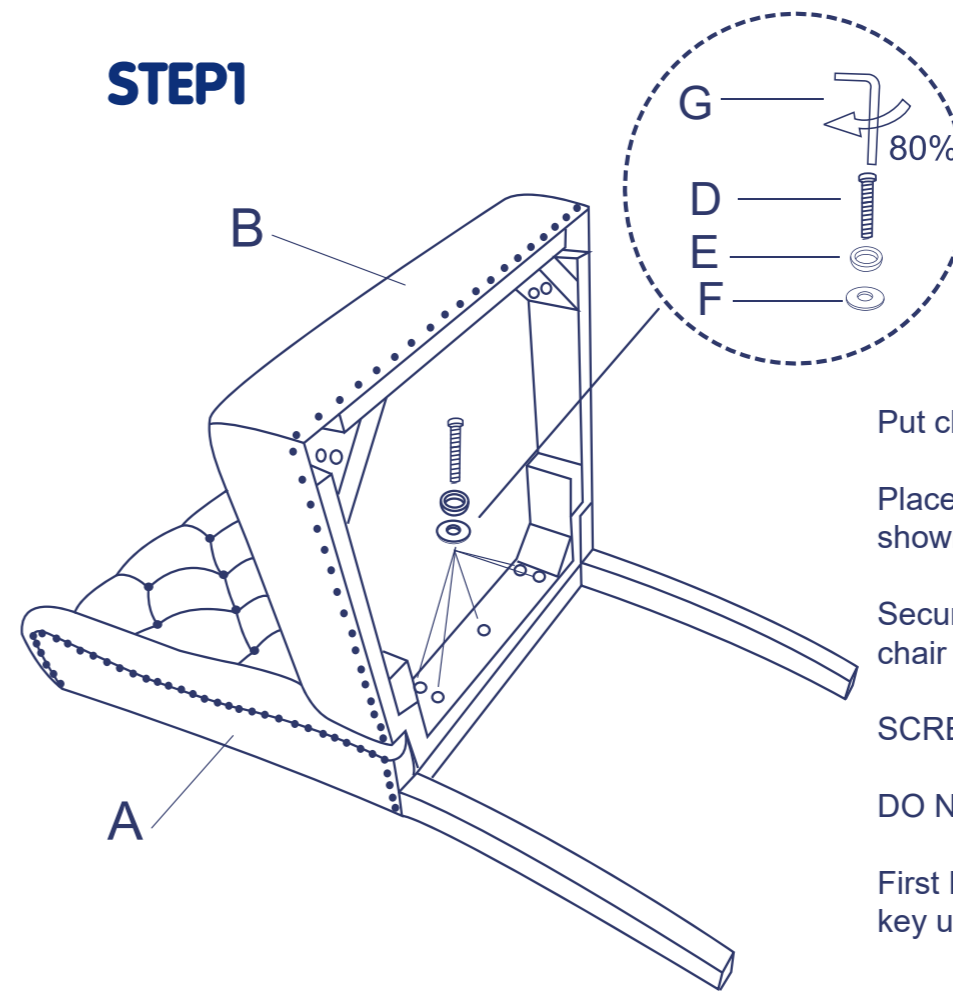

Put chair back on a clean flat surface.

Place seat pad against chair back as shown in diagram.

Secure center holes of the seat pad to chair back by using SHORTER

SCREW (D) with Washer (#E,F).

DO NOT FULLY TIGHTEN.

First HAND tighten then tightened using key up-to 60-80% only at this stage.

STEP2

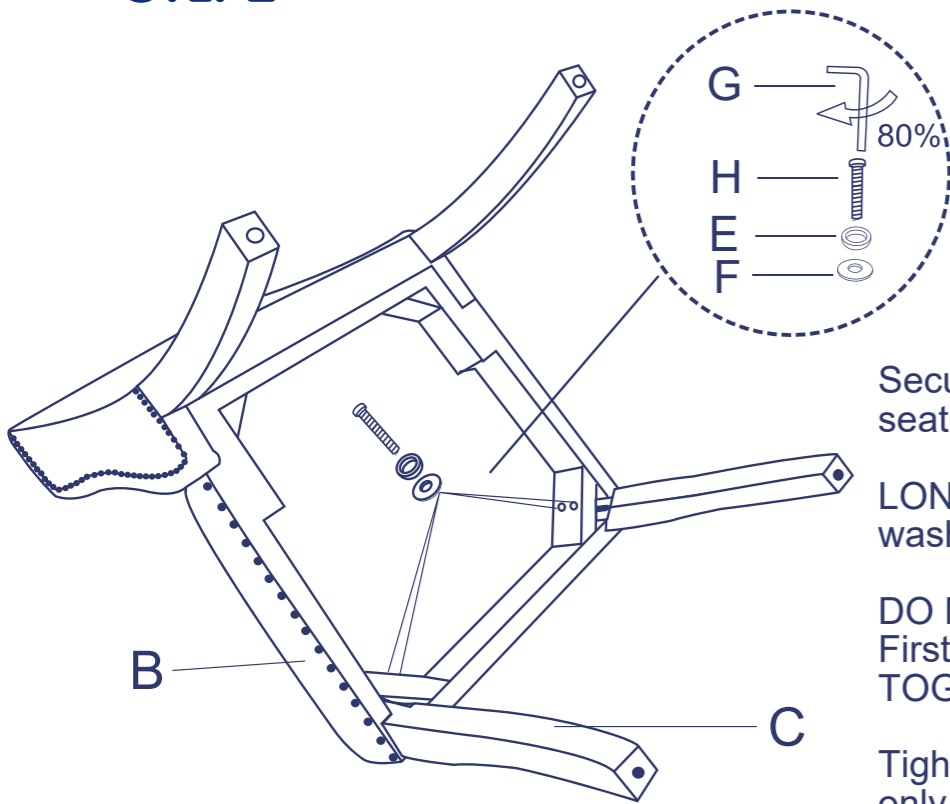

Secure both corner holes of the seat pad to the chair back by using

LONGER SCREWS (H) with washers (#E,F).

DO NOT FULLY TIGHTEN.
First HAND tighten All 4 screws TOGETHER at the same time.

Tightened up-to 60-80% using key only at this stage.

STEP3

Put chair in the upright position and SIT ON THE CHAIR to press downwards on the seat pad ensuring that all 4 feet touch the ground and chair is leveled.

Proceed to tighten all screws making sure the chair remains level when tightening. Check that all screws are tight on a regular basis to ensure chair remains level and secure.

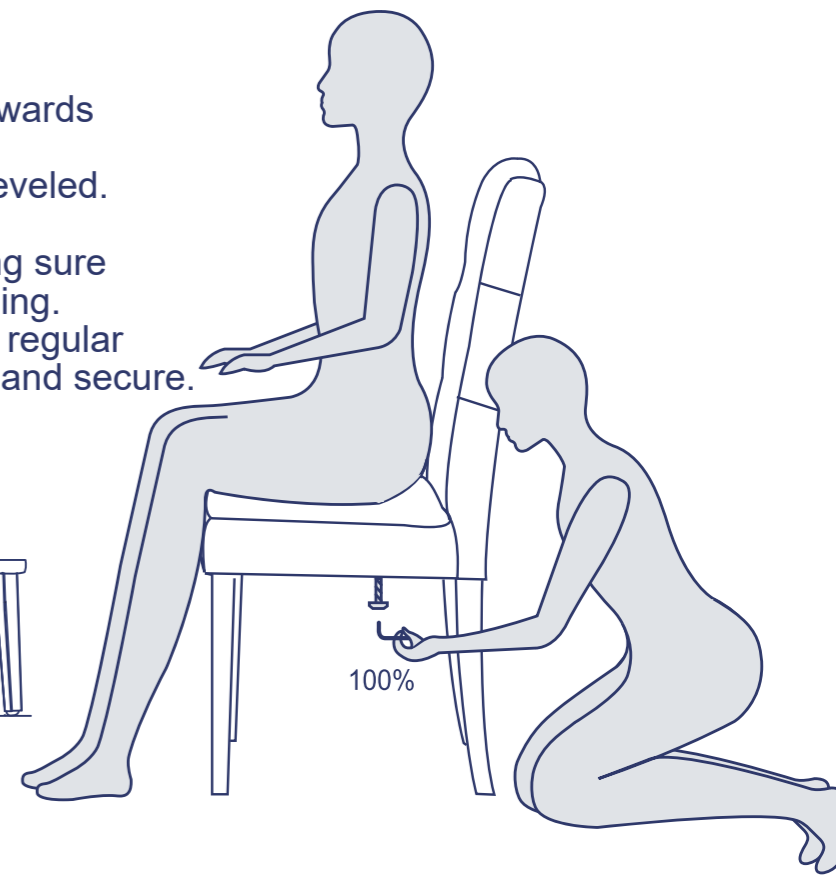
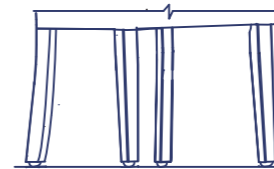
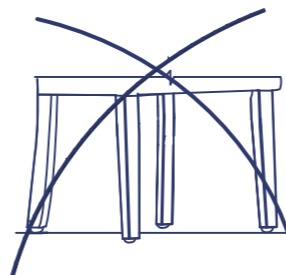

STEP4

Put the fabric cover under the seat
after 100% finished chair assembly

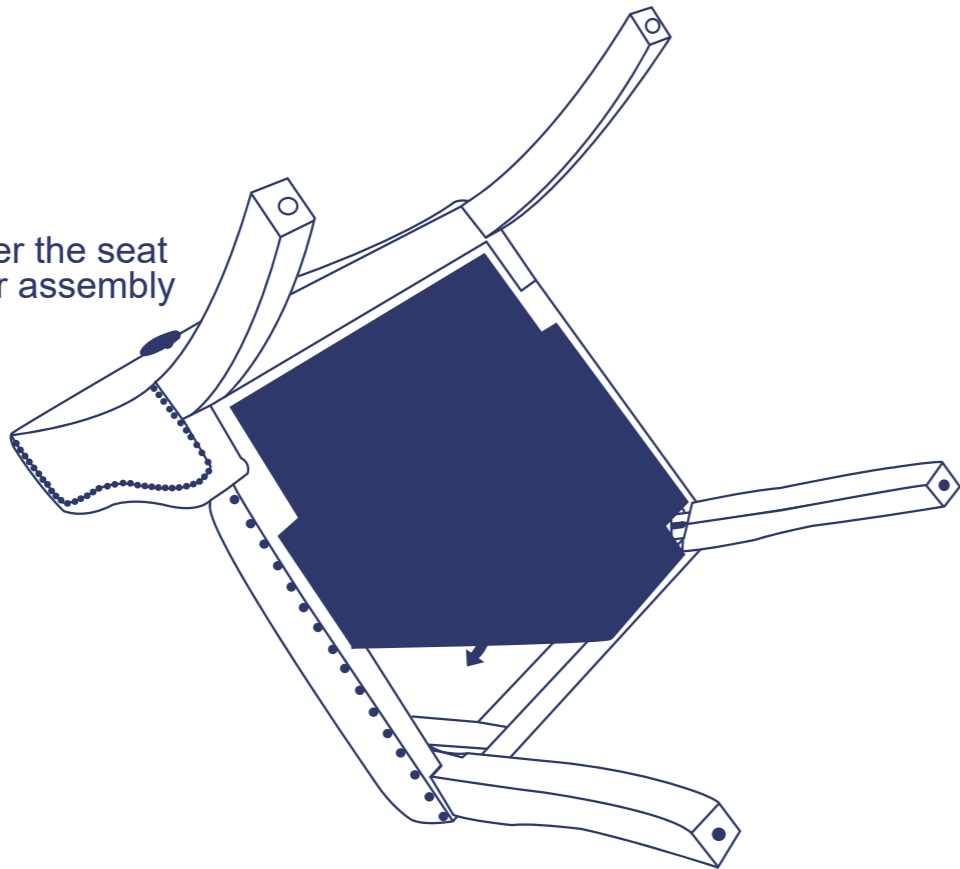
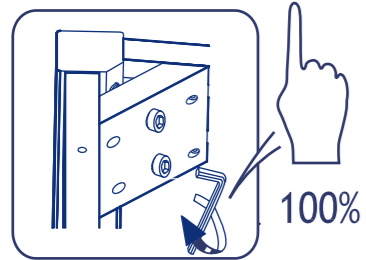

STEP5

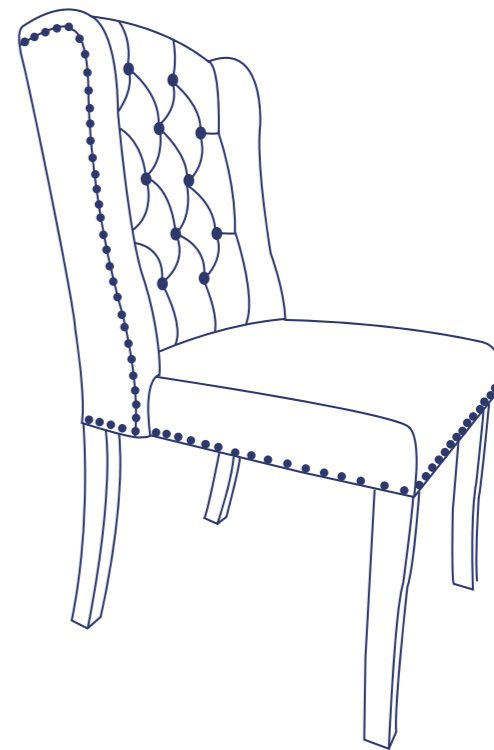
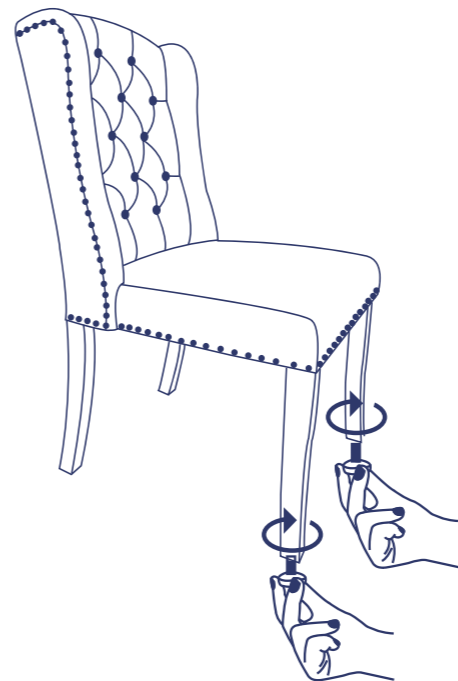

Several days after the initial installation,
the product can acclimate to its new
environment. Please ensure that all
screws are still tightened to 100%.