







ASSEMBLY INSTRUCTIONS & PARTS IDENTIFICATION RECT TABLE

Thank you for purchasing this quality product. Be sure to check all packing material carefully for small parts that may have come loose inside the carton during shipment

KeyParts			
No		Qty	Description
1		1pc	Tabletop
2		2pcs	Leg Assembly
3		1pcs	Support Stretcher
4		4pcs	Floor Glide

Hardware kit			
No		Description	Qty
A		Flat washer (Large) For Bracket	16 pcs
B		Flat washer (Small) For Stretcher	3 pcs
C		Lockwasher	19 pcs
D		Bolt 8x25mm - To attach the Bracket	16 pcs
E		Bolt 8x75mm - To attach Support Stretcher	3 pcs
F		Allen Key	1 pcs
G		Metal Corner Bracket	8 pcs

Step 1

Attach the Support Stretcher to the tabletop using a Long Bolt E, Lock Washer C, and Small Flat Washer B. Fully tighten all bolts after all three bolts are in place.

SETUP REQUIRES 2 PEOPLE

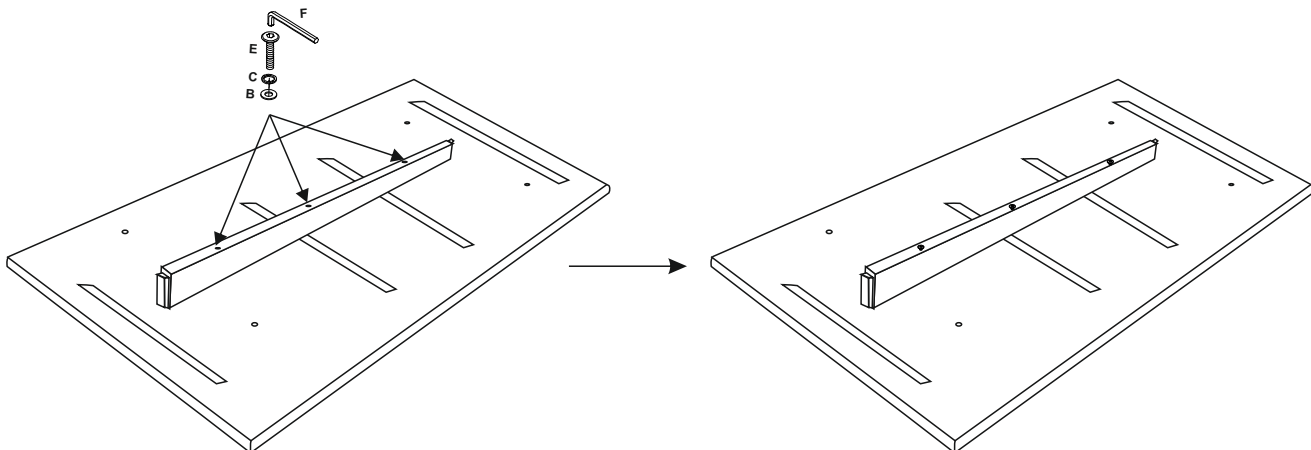

Step 2

Attach two Metal Corner Brackets G to the inside and outside of each panel of the Leg Assembly using a Short Bolt D, Lock Washer C, and Large Flat washer A. Do not fully tighten at this point.

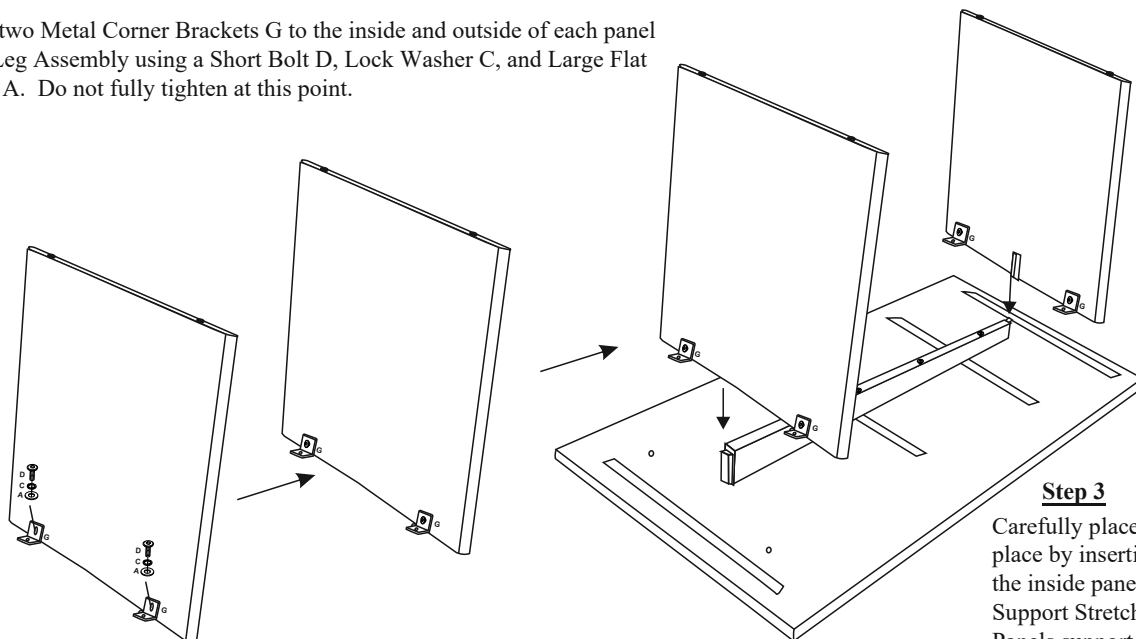







Step 3

Carefully place the Leg Assembly into place by inserting the notched portion of the inside panel to the receiver on the Support Stretcher. Keep Leg Assembly Panels supported.

ASSEMBLY INSTRUCTIONS & PARTS IDENTIFICATION RECT TABLE

Thank you for purchasing this quality product. Be sure to check all packing material carefully for small parts that may have come loose inside the carton during shipment

KeyParts			
No		Qty	Description
1		1pc	Tabletop
2		2pcs	Leg Assembly
3		1pcs	Support Stretcher
4		4pcs	Floor Glide

Hardware kit			
No		Description	Qty
A		Flat washer (Large) For Bracket	16 pcs
B		Flat washer (Small) For Stretcher	3 pcs
C		Lockwasher	19 pcs
D		Bolt 8x25mm - To attach the Bracket	16 pcs
E		Bolt 8x75mm - To attach Support Stretcher	3 pcs
F		Allen Key	1 pcs
G		Metal Corner Bracket	8 pcs

Step 4

Attach the Metal Corner Bracket to the tabletop using a Short Bolt D, Lock Washer C, and Large Flat washer A. Once all bolts are on place, fully tighten by hand using the provided Allen Key.

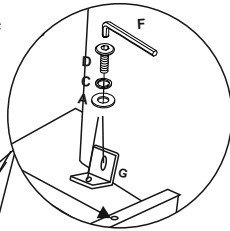

SETUP REQUIRES 2 PEOPLE

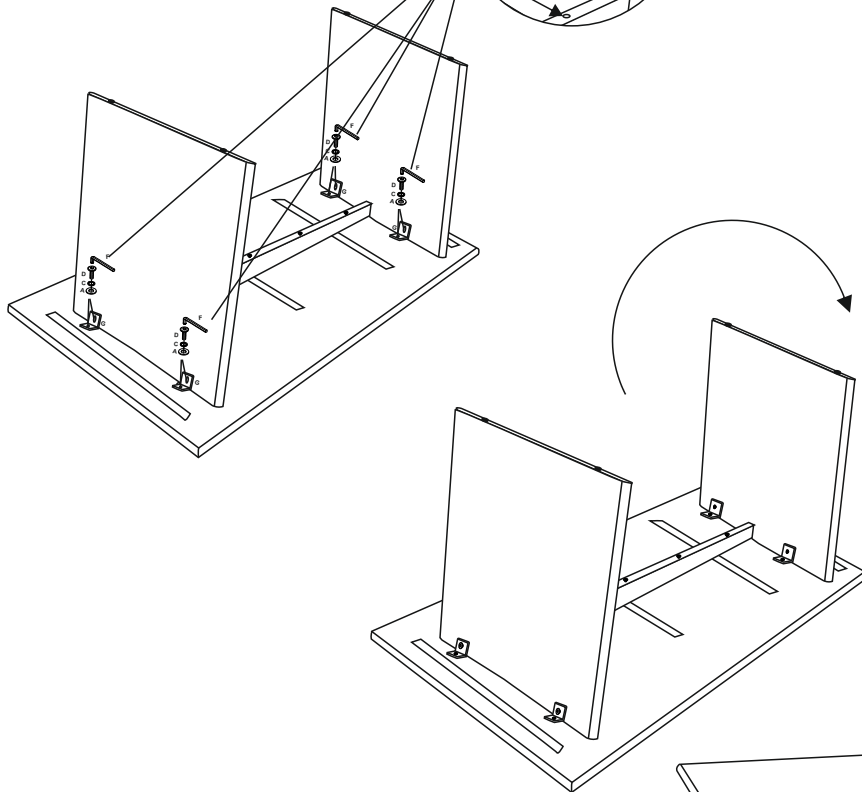

Step 5

With the help of a second person turn the table upright. Do not put any pressure on the end flat portion of the leg panel when turning the table.

