

Owner Manual

WARNINGS AND CAUTIONS

Released Date: 2025-01

READ AND SAVE THESE INSTRUCTIONS

Please read and understand this entire manual before attempting to assemble, install or operate the product.

WARNING

- **RISK OF ELECTRIC SHOCK** - Before beginning installation, turn off electricity at the circuit breaker box or the main fuse box.
- **RISK OF FIRE** - Use bulbs specified by the markings and/or labels on the fixture.
- **RISK OF PERSONAL INJURY** - **DO NOT** bend the blades when installing the fan, or cleaning the fan. Do not insert foreign objects in between rotating fan blades.
- **RISK OF FIRE, ELECTRIC SHOCK, OR PERSONAL INJURY** - mount to outlet box marked and use mounting screws provided with the outlet box.
- All set screws must be checked, and re-tightened where necessary, before installation.
- After making the wire connections, the wires should be spread apart with the grounded conductor and the equipment-grounding conductor on one side of the outlet box and the ungrounded conductor on the other side of the outlet box.
- This unit weights 6kg(13.23 lbs).

CAUTION

- For your safety, read instructions completely before beginning installation.
- If in doubt about electrical installation, consult a licensed electrician.
- Disconnect fixture from the power source before replacing bulbs or cleaning. Make sure the bulbs are given sufficient time to cool be before removing.

TOOLS REQUIRED

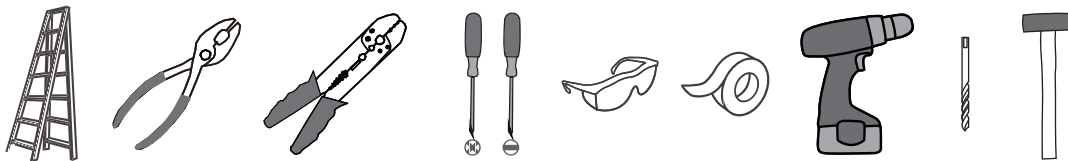

CARE AND MAINTENANCE

- Wipe clean using soft, dry cloth or static duster. Always avoid using harsh chemicals and abrasives to clean fixture as they may damage the finish.

PACKAGE CONTENTS

A Lamp body
X1

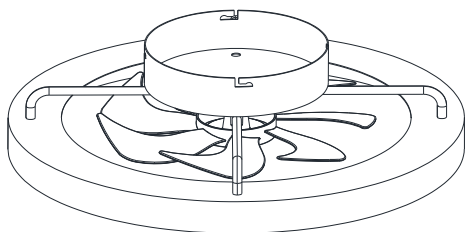

B Mounting Bracket
X1

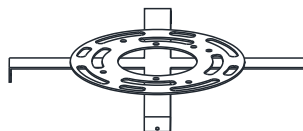

PACKAGE CONTENTS (PARTS BAG 1)



AA



BB



CC



DD



EE



NOTE: Hardware not shown to actual size.



FF

AA	Wire Connector	4
BB	Screw	4
CC	Wall Anchor	4
DD	Anchor Bolt	2
EE	Mechanical Screw	2
FF	glove	2

PACKAGE CONTENTS (PARTS BAG 2)



MM Remote Control
Transmitter
x 1

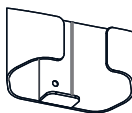

OO Wall Bracket
x 1



PP Screw
x 2

1 Take the hanging board

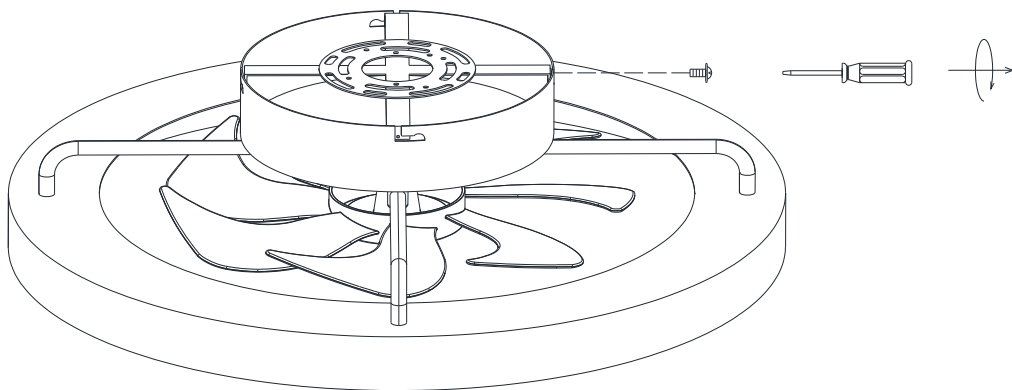

2 Install the hanging board

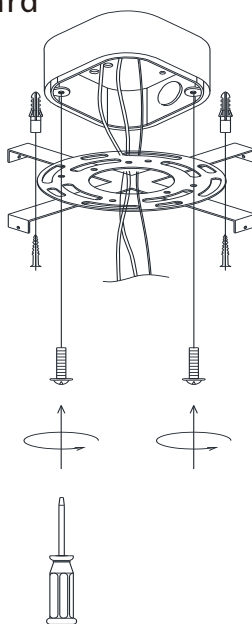

3 Wiring

- 1: connect the wires from the fixture to the house supply wires with Wire Nut, ground wire (green, green/yellow, or bare) to ground wire, neutral wire (white) to neutral wire, and hot wire (black) to the hot wire. Wrap the connection with electrical tape.
- 2: Spread apart the wires so that the hot wires are on one side of the outlet box and the neutral wires are on the other side.

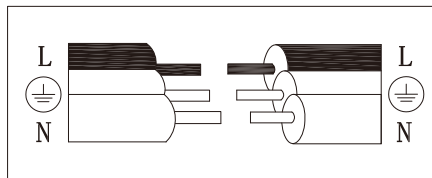
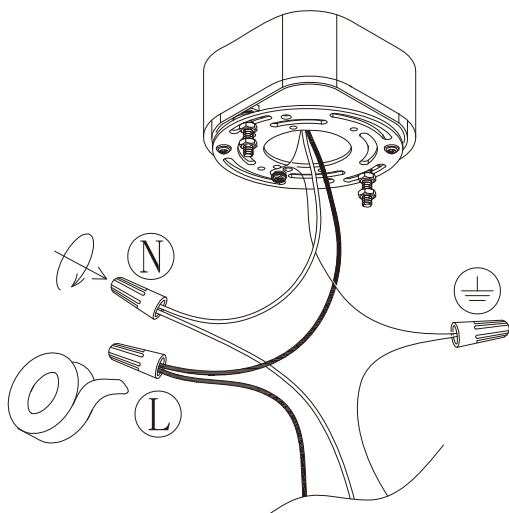

4 Install lighting fixtures

Attention: The hanging plate screws should be placed at the semi-circular hole position

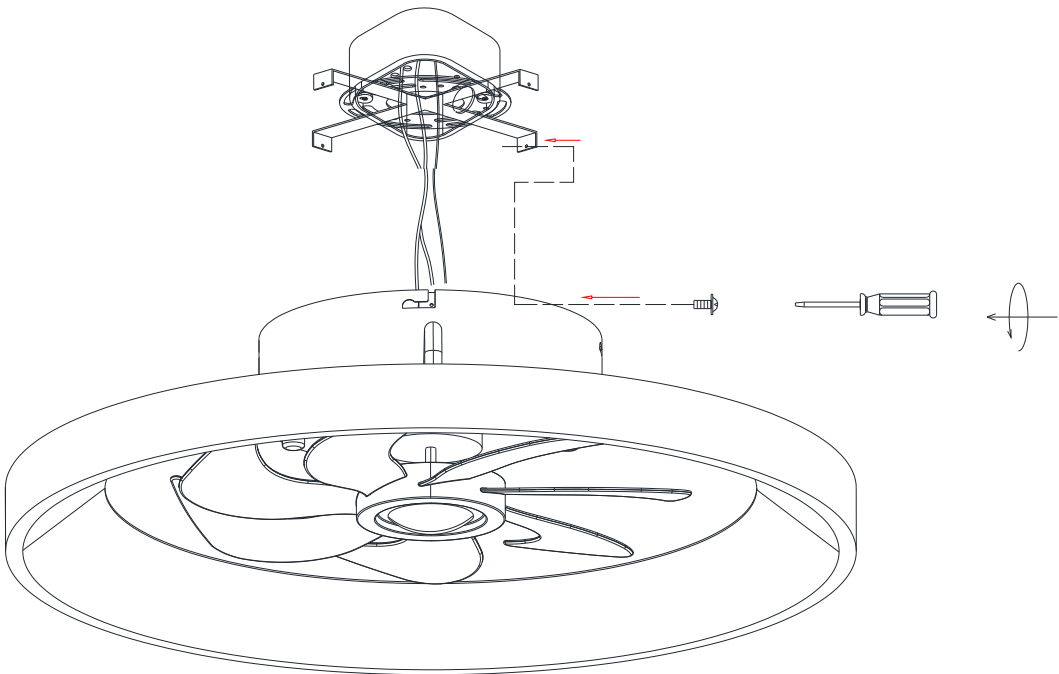

5 Install Wall Bracket

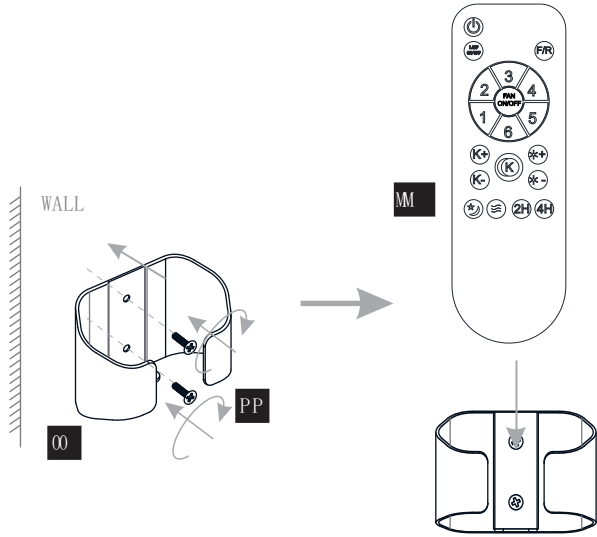

6 Remote Control Instructions

1

Remove the back cover

2

Installing the battery

3

Close the back cover

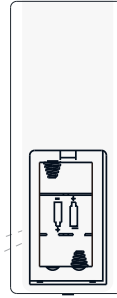
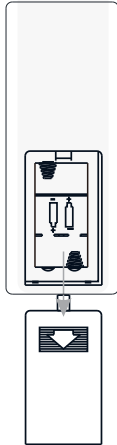
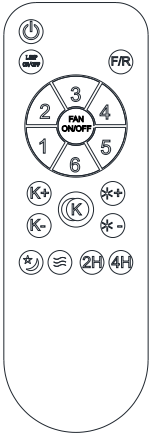

AAA Batteries

be careful: Battery not included

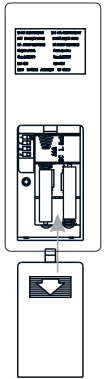

General off

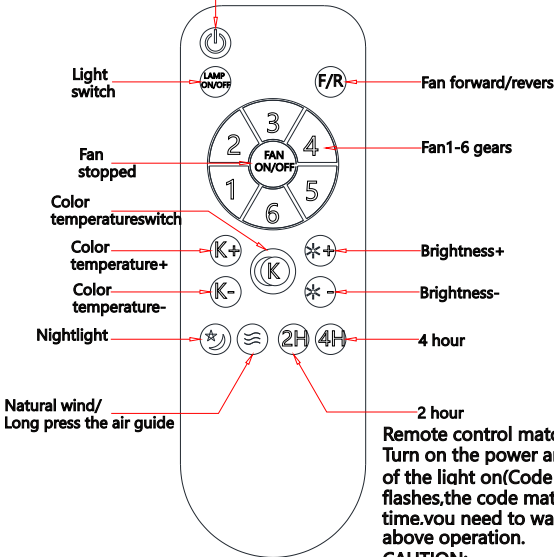

Remote control matching code:

Turn on the power and Press and hold the light pairing key within 5 seconds of the light on(Code building:). When you hear a beep or a light flashes,the code match is successful.If you need to match the code a second time.you need to wait 30 seconds before turning on the power and repeat the above operation.

CAUTION:

The electronic switch is not an isolated product and needs to be operated by professional personnel during installation
The electronic switch is triqgered by the remote control,and the wireless frequency of the remote control transmitter is

Your installation is now complete. Save this sheet for future