

# SHOWER ROD

## CURVED SHOWER CURTAIN ROD

SKU: 911700



### FEATURES

- Rod may be shortened to desired length by trimming equal amounts from each end.
- Packed in individual carton with two Shower Curtain Rod Swivel Flanges and installation materials.
- Mounting hardware included.
- For best fit, shower curtain should be 6" - 12" wider than shower rod.
- To determine your rod size, measure straight across from wall to wall.
- Curves in the rod and mounting brackets are already accounted for.
- Choose from 48", 60", 66" and 72".

### CONTENTS

48" ROD	.....	PAGE 2
60" ROD	.....	PAGE 3
66" ROD	.....	PAGE 4
72" ROD	.....	PAGE 5

REVISED 10/08/2021

# 48" SHOWER ROD

## CURVED SHOWER CURTAIN ROD

SKU: 911700-48, 466753, 466754, 466755, 466756, 466757

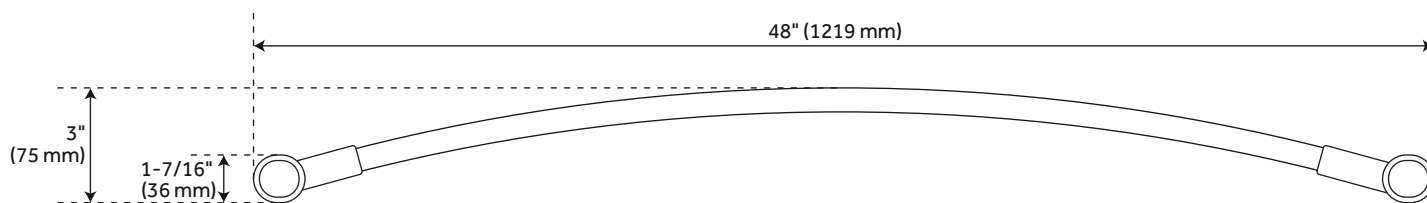
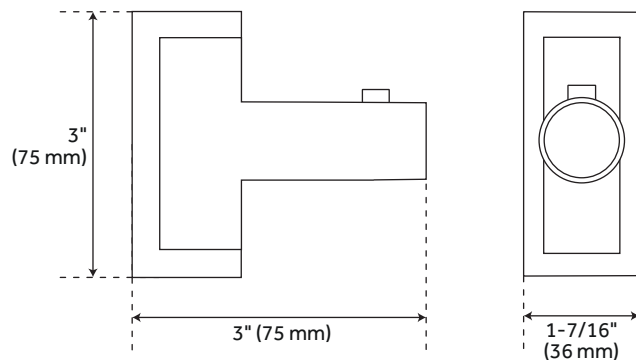

### FEATURES

- Shower Rod Diameter: 1"
- Shower Rod Length: 48"
- Flange Length: 3"
- Flanges Width: 1-3/4"
- Flange Height: 2-1/4"
- Shower Rod Curves: 20°

### PRODUCT IMAGE



All dimensions and specifications are nominal and may vary. Use actual products for accuracy in critical situations.

PAGE 2  
Code: SH555005

# 60" SHOWER ROD

## CURVED SHOWER CURTAIN ROD

SKU: 911700-60, 466758, 466759, 466760, 466761, 466762

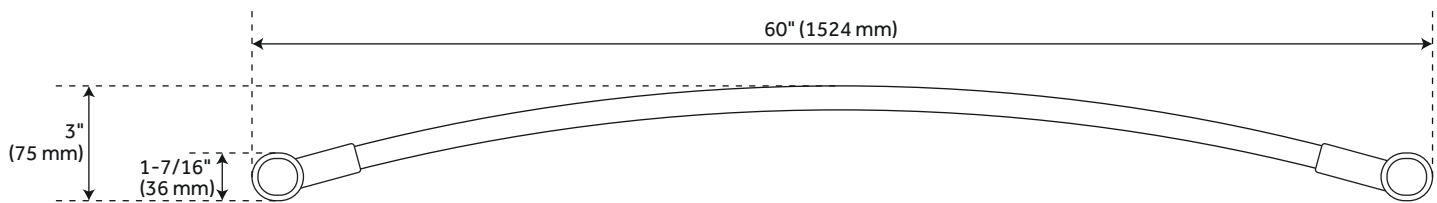
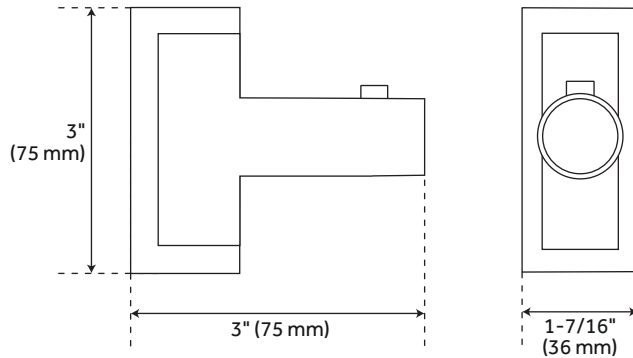

### FEATURES

- Shower Rod Diameter: 1"
- Shower Rod Length: 60"
- Flange Length: 3"
- Flanges Width: 1-3/4"
- Flange Height: 2-1/4"
- Shower Rod Curves: 22°

### PRODUCT IMAGE



All dimensions and specifications are nominal and may vary. Use actual products for accuracy in critical situations.

PAGE 3  
Code: SH555006

# 66" SHOWER ROD

## CURVED SHOWER CURTAIN ROD

SKU: 911700-66, 466763, 466764, 466765, 466766, 466767

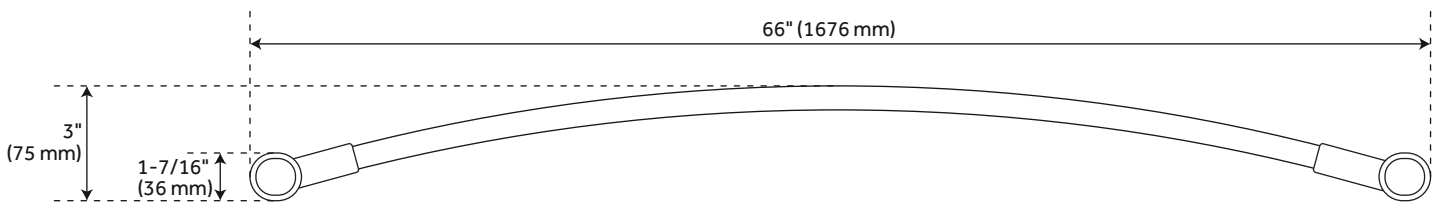
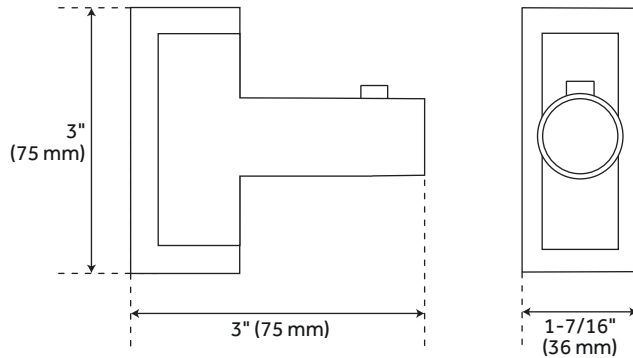

### FEATURES

- Shower Rod Diameter: 1"
- Shower Rod Length: 66"
- Flange Length: 3"
- Flanges Width: 1-3/4"
- Flange Height: 2-1/4"
- Shower Rod Curves: 22°

### PRODUCT IMAGE



All dimensions and specifications are nominal and may vary. Use actual products for accuracy in critical situations.

PAGE 4  
Code: SH555007

# 72" SHOWER ROD

## CURVED SHOWER CURTAIN ROD

SKU: 911700-72, 466768, 466769, 466770, 466771, 466772

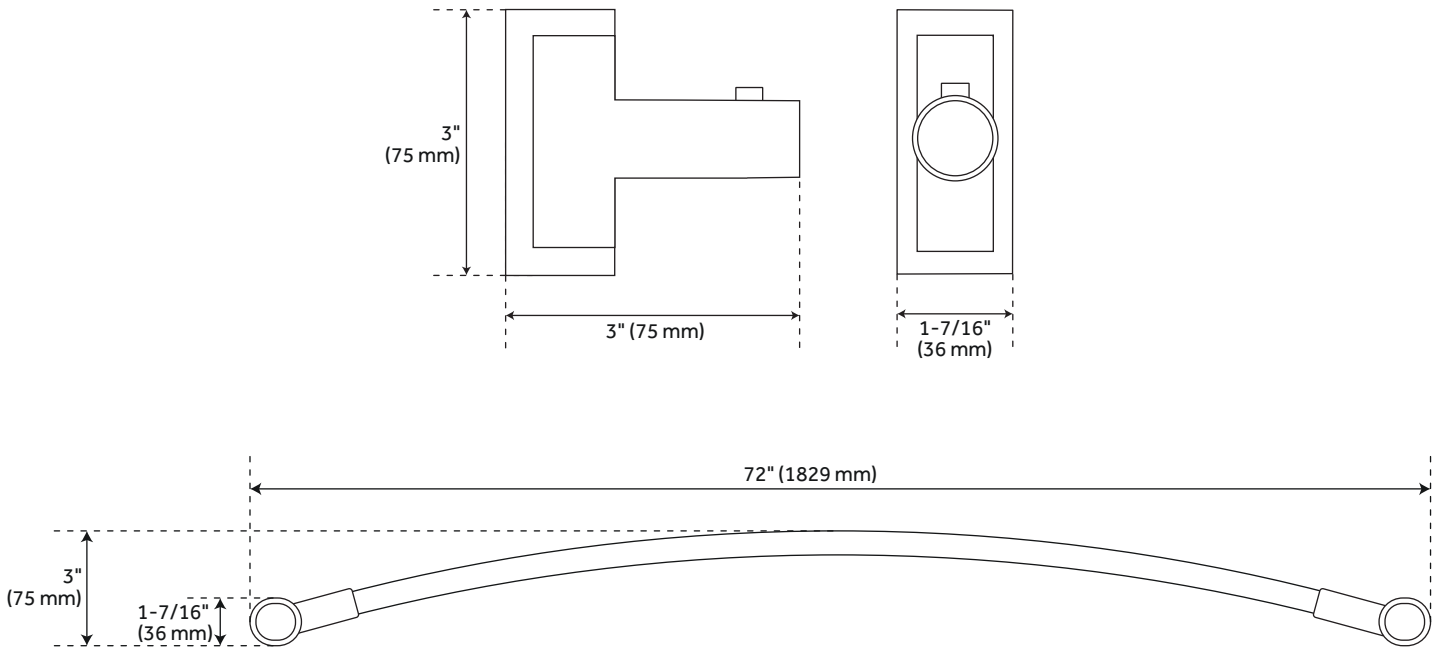

### FEATURES

- Shower Rod Diameter: 1"
- Shower Rod Length: 72"
- Flange Length: 3"
- Flanges Width: 1-3/4"
- Flange Height: 2-1/4"
- Shower Rod Curves: 22°

### PRODUCT IMAGE



All dimensions and specifications are nominal and may vary. Use actual products for accuracy in critical situations.

PAGE 5  
Code: SH555008