

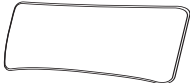

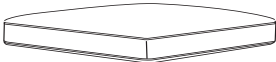

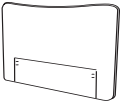

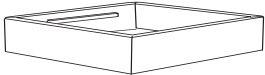



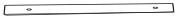

Assembly Instructions

Note: Please help to read my instruction before you ready to assemble.

Sofa



Part List			
Label	Picture	Description	QTY (PCS)
A		Back Cushion	2
B		Seat Cushion	2
C		Arm / Backrest	2
D		Seat Frame	2
E		Seat Panel	2
F		Wood Batten	4
G		Leg	8

Hardware List			
①		Plastic Washer	J
②		Metal Hook	I
③		Bolt(M6*35MM)	J
④		Flat Washer(M6)	J
⑤		Spring Washer(M6)	J
⑥		Bolt(M6*20MM)	13
⑦		Metal Connector	2
⑧		Plastic Clip	2
⑨		Allen Wrench(S4)	1

STEP 1

x2

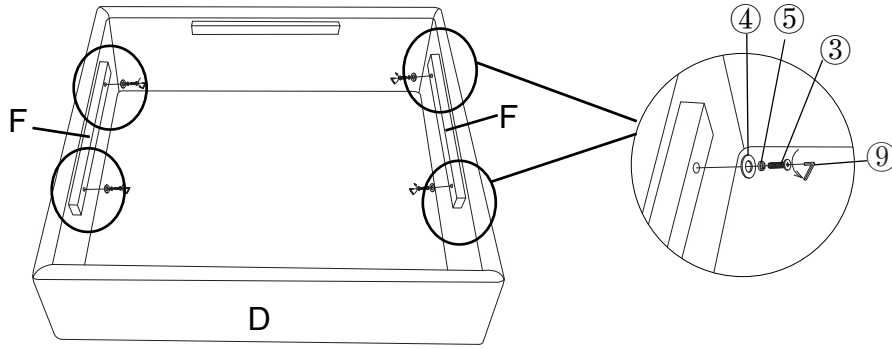

STEP 2

x2

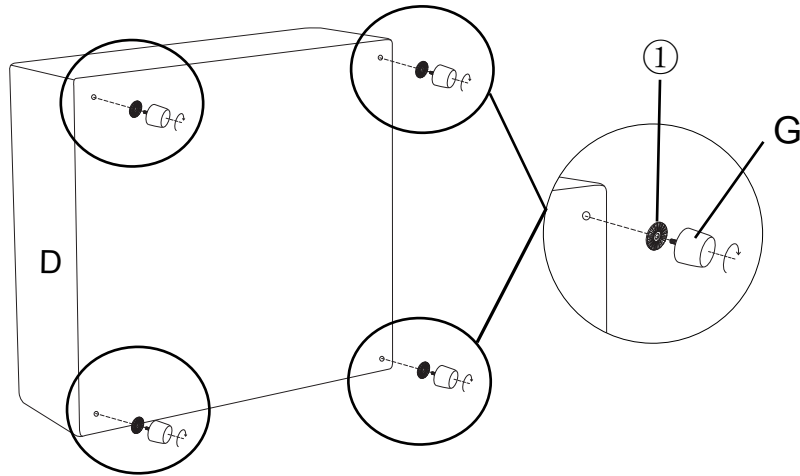

STEP 3

x2

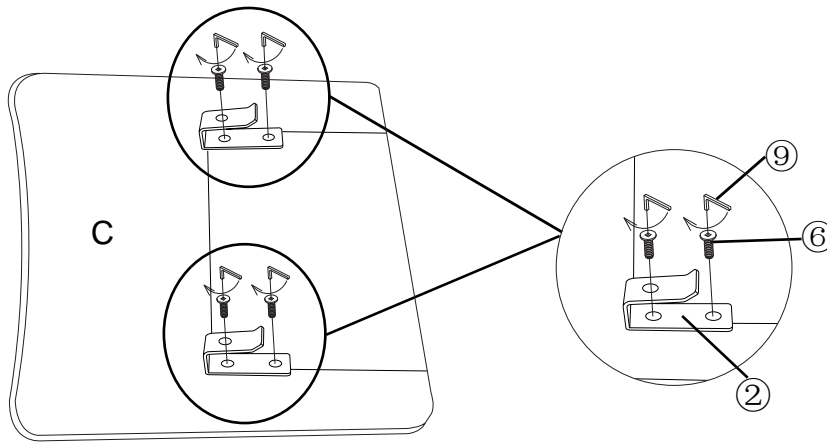

STEP 4

x2

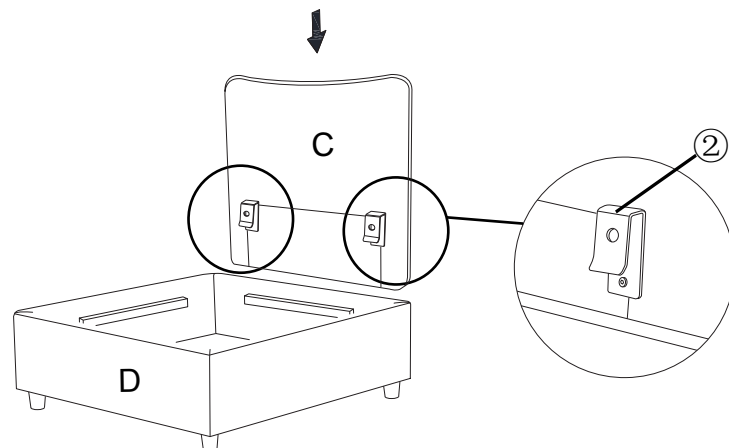

STEP 5

X2

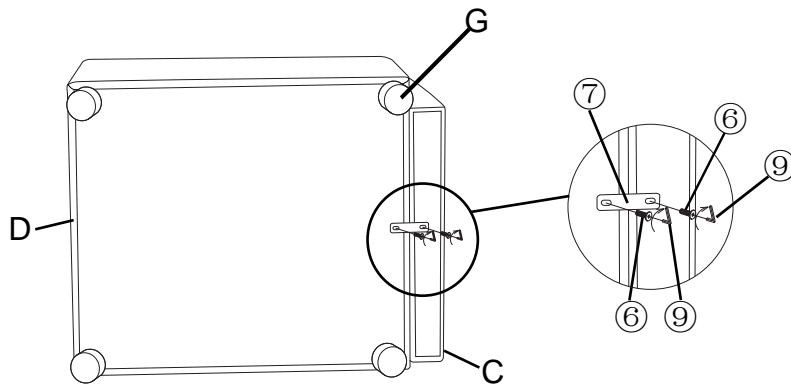

STEP 6

X2

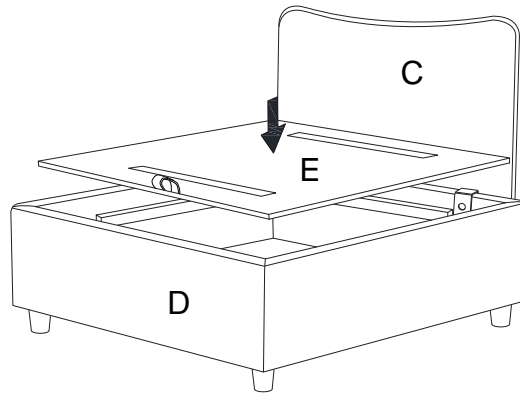

STEP 7

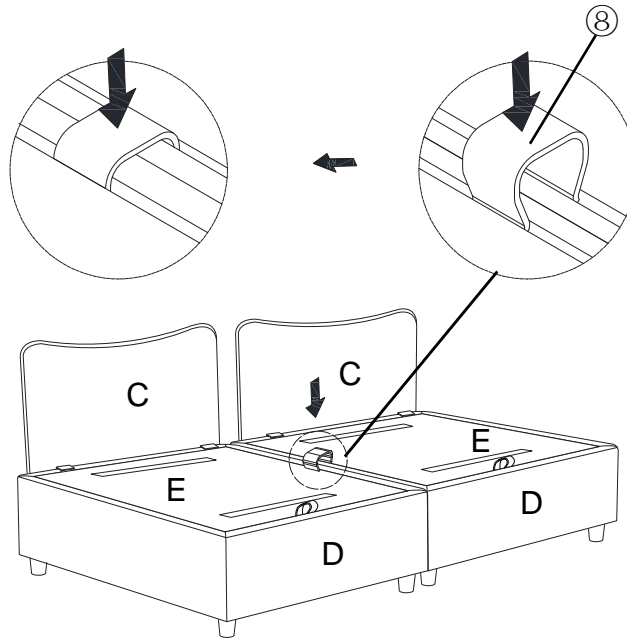

STEP 8

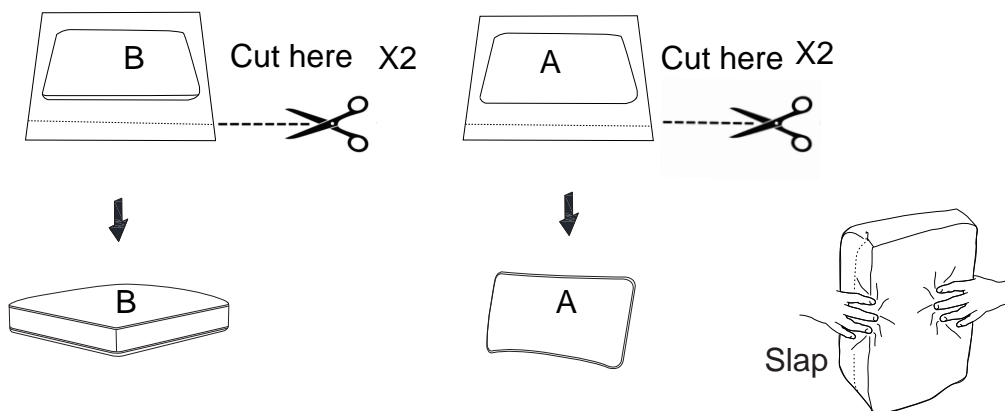

STEP 9

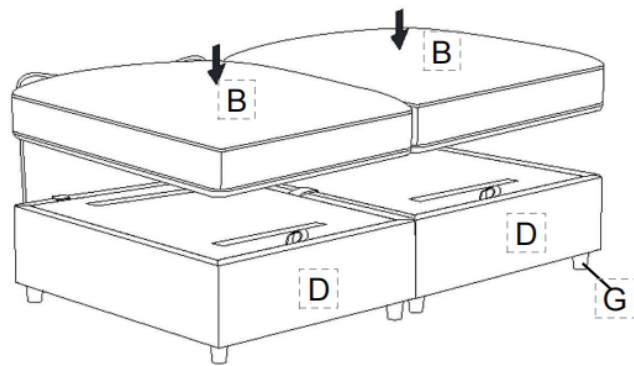

STEP 10

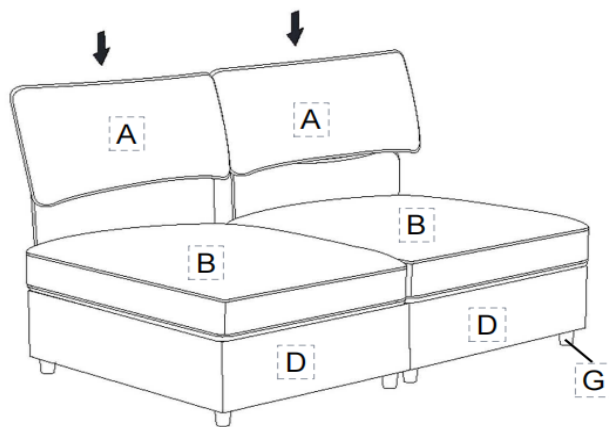

STEP 11

