

Instruction Manual



Thank you for shopping with us!

If any parts is missing, broken upon receipt or you need any help from us. for the FASTEST solutions, please FIRSTLY CONTACT US



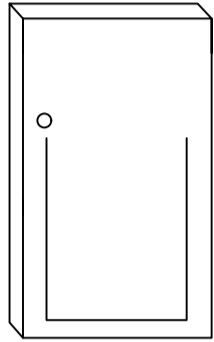
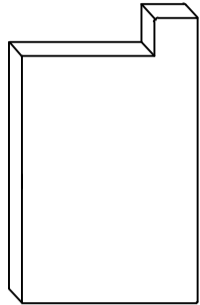
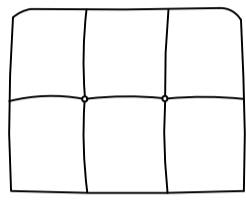
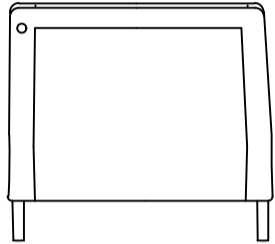
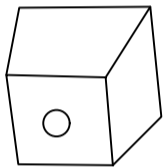
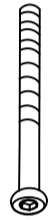
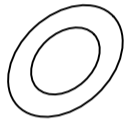
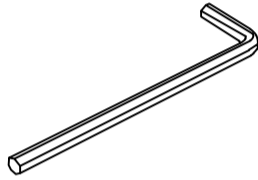
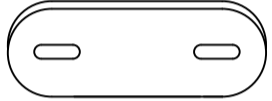
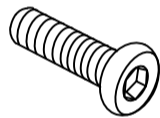
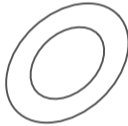
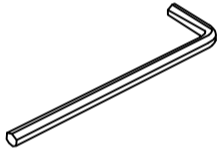

Accessories list

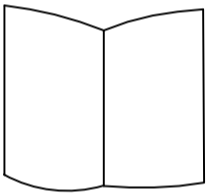
2 Seater sofas on the left

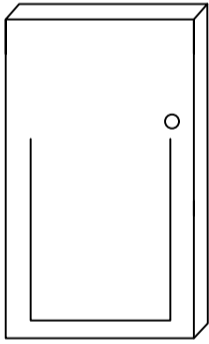
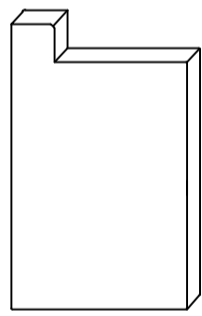
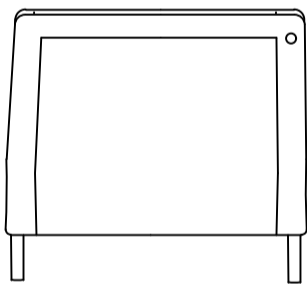
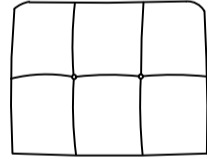
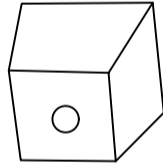
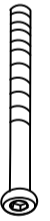
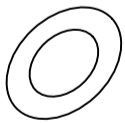

Note: all the parts or hardware marked with*are tucked under seat frame

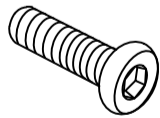
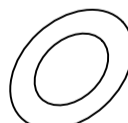
A  Left seat frame(1)	B  Left seat cushion(1)	C*  Backrest cushion(1)	R*  Left backrest(1)	
D*  13cm Leg(6)	E*  8*100 Screw(6)	F*  17mm Gasket(6)	G*  M5*100*45mm Wrench(1)	H*  50 Metal plate(1)
I*  6*25 Screw(2)	J*  13mm Gasket(2)	K*  M4*65*23 Wrench(1)	L*  85mm U connector(1)	 Instruction Manual(1)

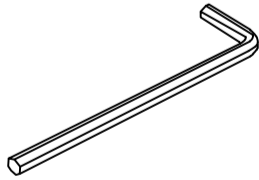
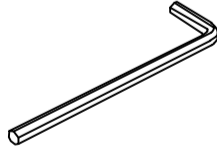
2 Seater sofas on the right

M  Right seat frame(1)	N  Right seat cushion(1)	S*  Right backrest(1)	C*  Backrest cushion(1)	D*  13mm Leg(6)	E*  8*100 Screw(6)	
F*  17mm Gasket(6)	H*  50 Metal plate(1)	I*  6*25 Screw(2)	J*  13mm Gasket(2)	L*  85mm U connector(1)	G*  M5*100*45mm Wrench(1)	K*  M4*65*23 Wrench(1)

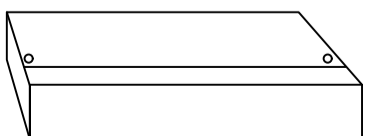
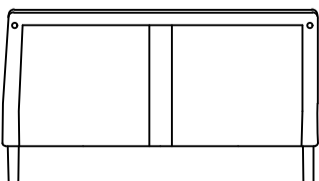
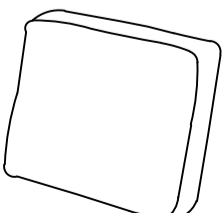
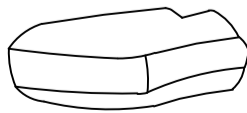
2 Seater sofa

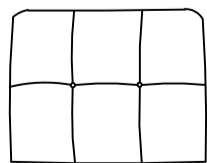
O  Double seat frame(1)	P  Double backrest(1)	Q*  Seat cushion(2)	T*  Left armrest soft bag(1)	U*  Right armrest soft bag(1)	C*  Backrest cushion(2)
---	---	---	--	---	---

STEP1:

Get all the hidden parts out of A, M and O

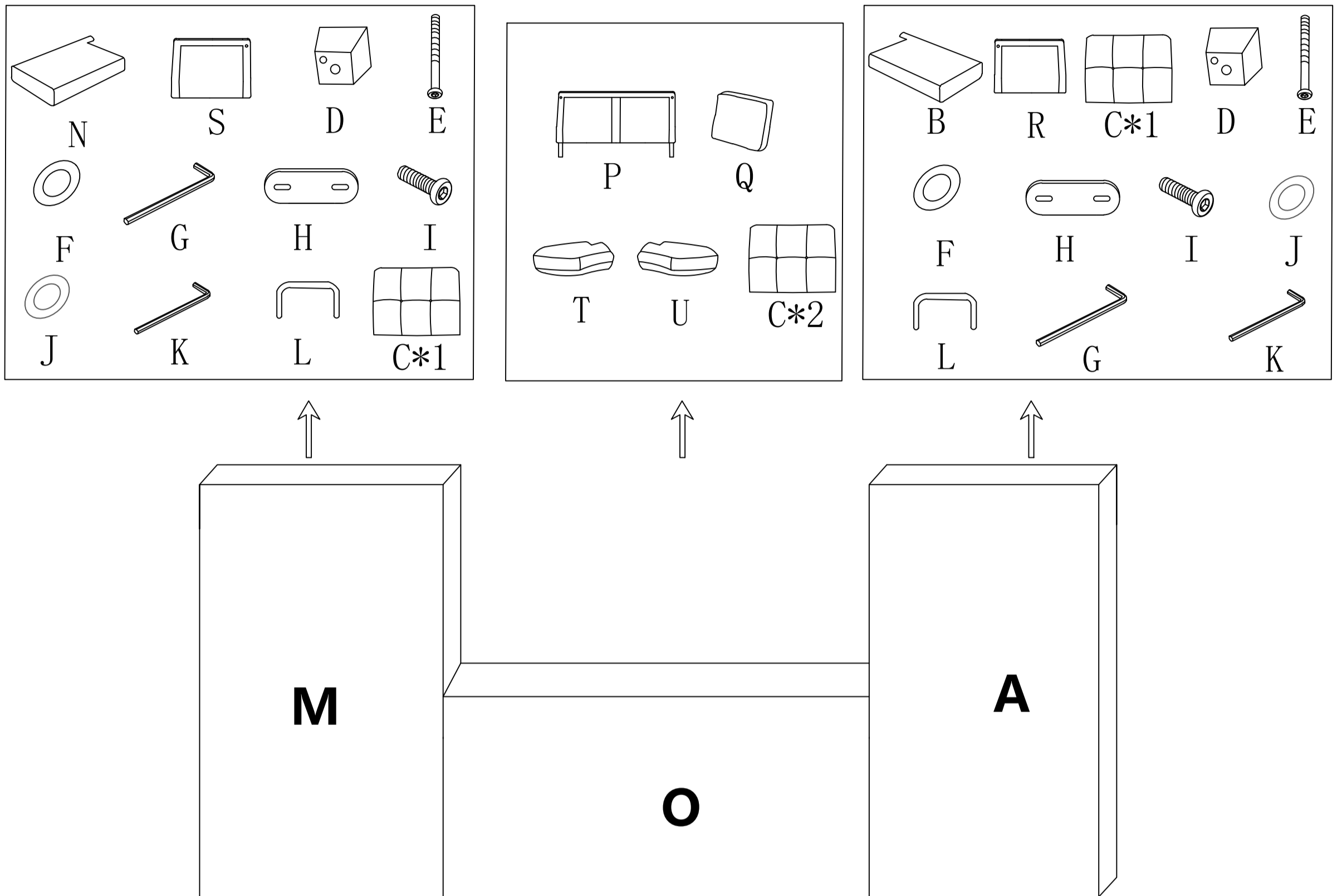

STEP2:

Install the sofa legs of the left Consort

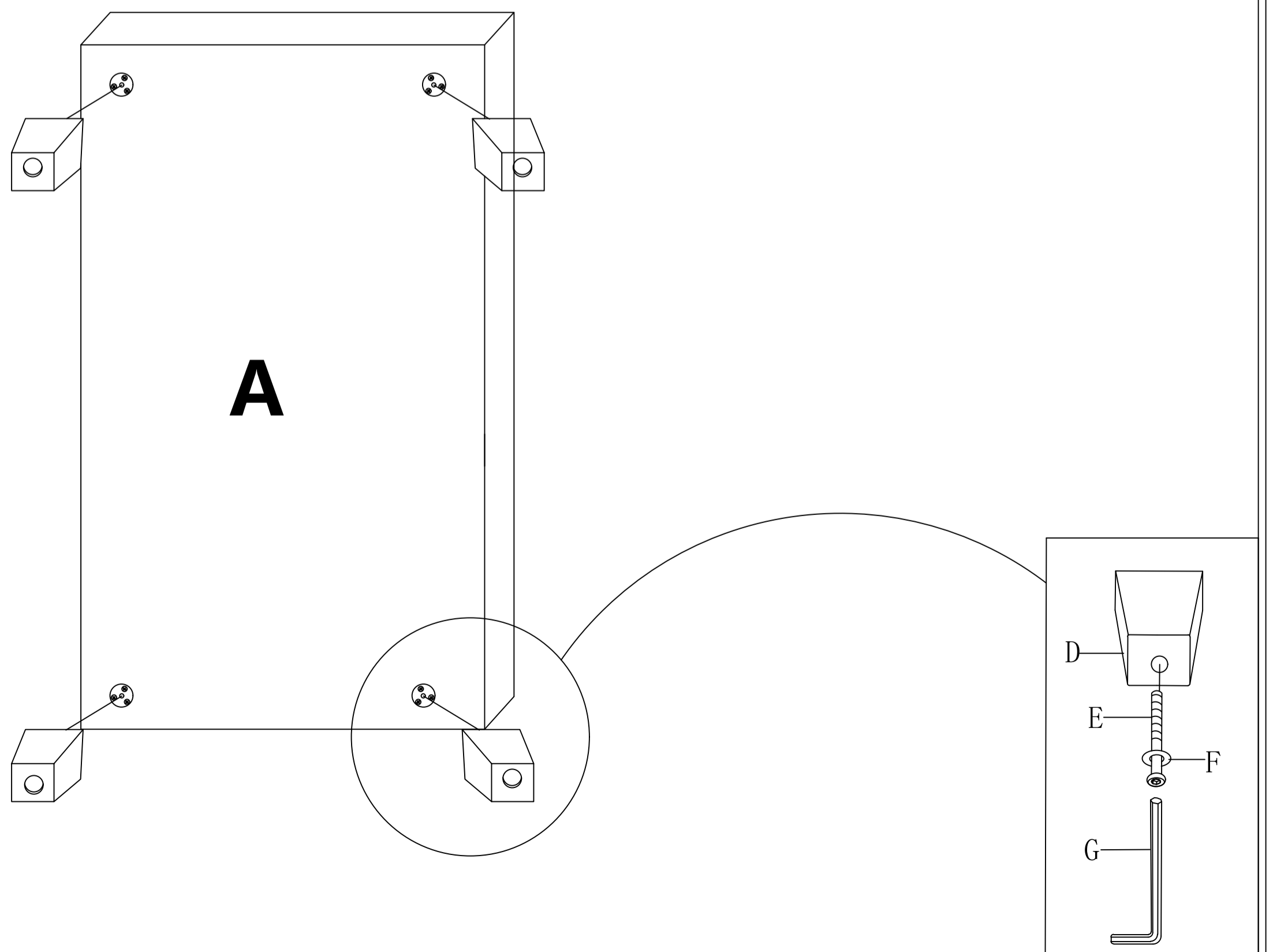

STEP3:

Install the sofa legs of the right Consort

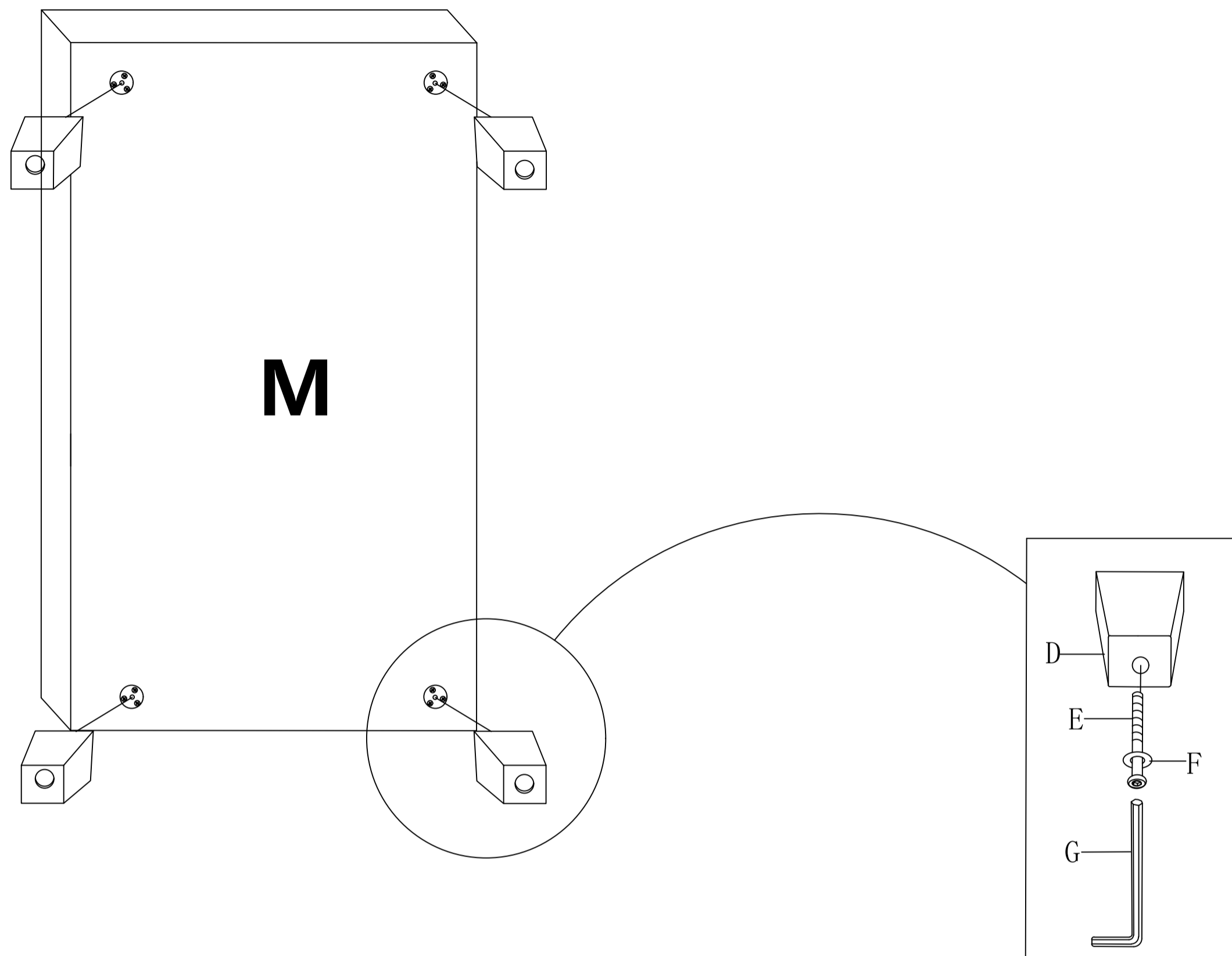

STEP4:

Install the 2-seater sofa legs

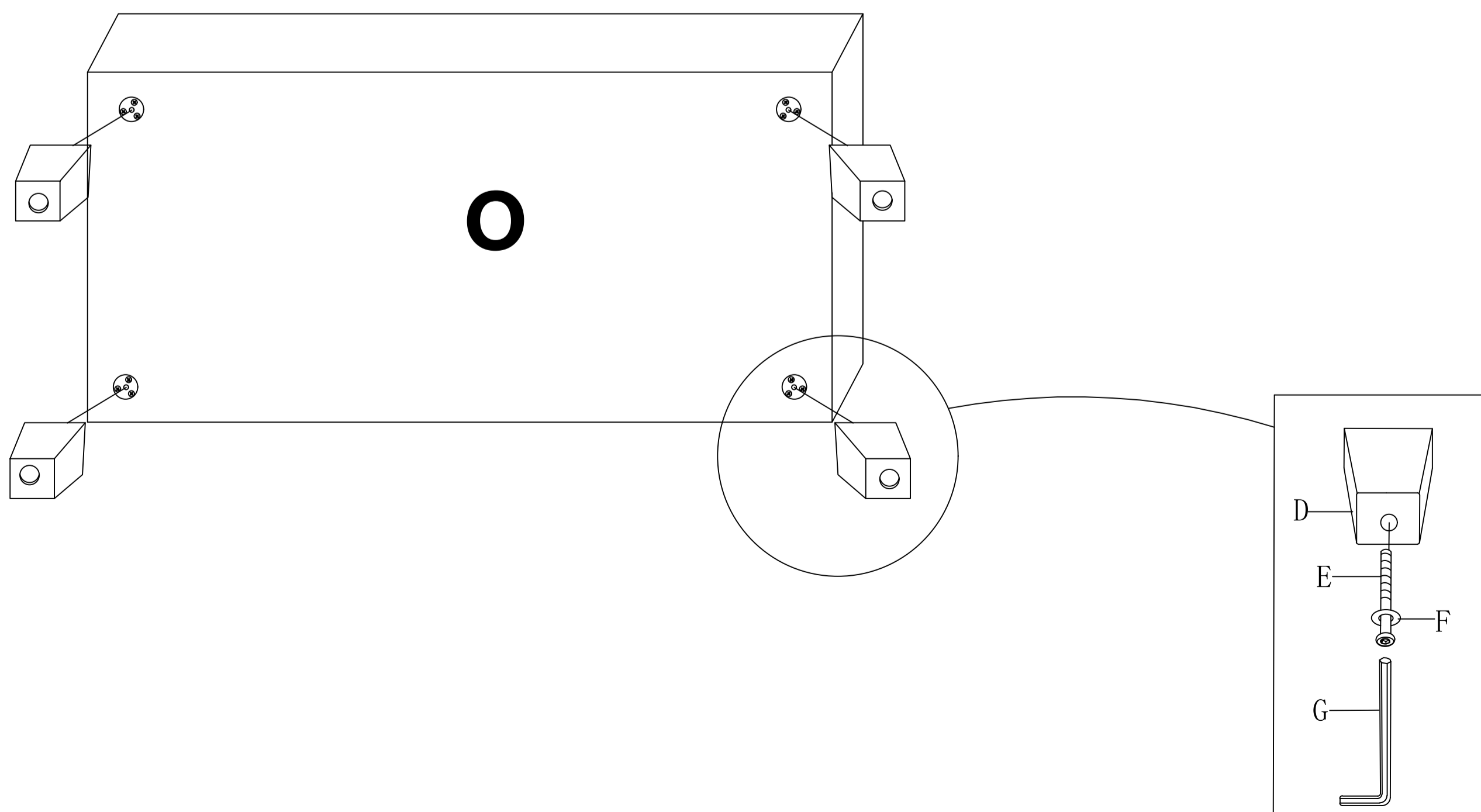

STEP5:

Connect the sofa seat frame with U hooks

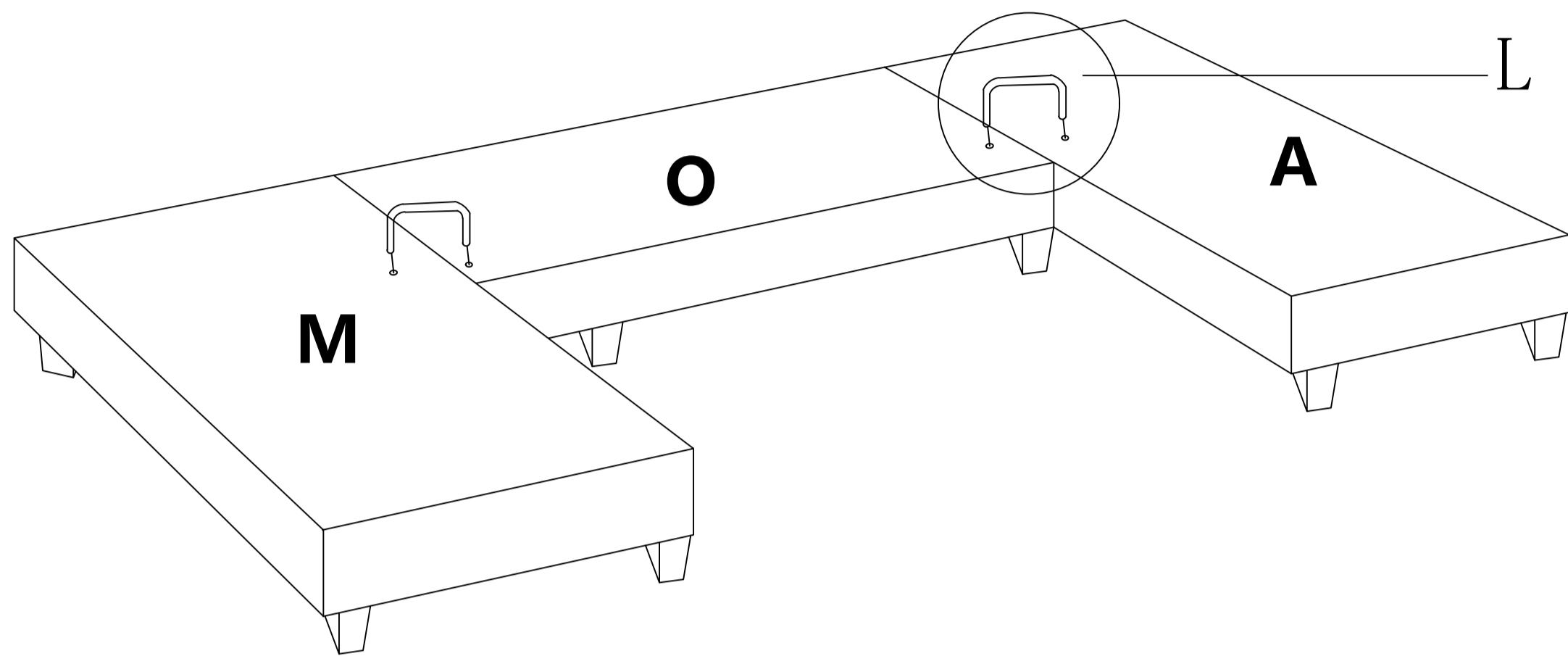

STEP6:

Insert the back of the left and right sofas and the 2-seater sofa back into the seat frame

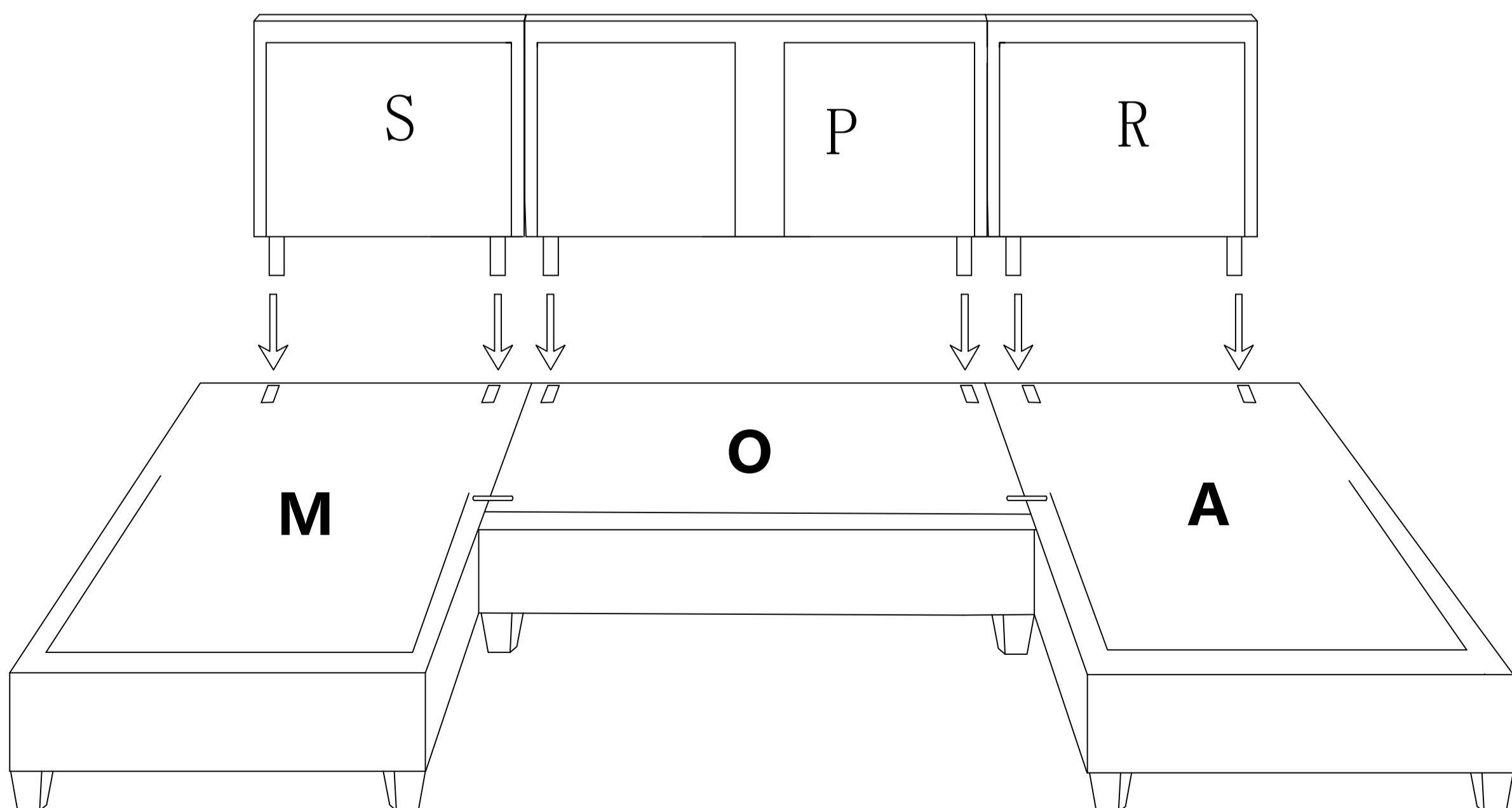

STEP7:

Lock the backrest with the metal plate

Note: This design is for reinforcing the back, sometimes the holes may not line up because they are at different back boards. It's normal so long as the metal plate can fit into place

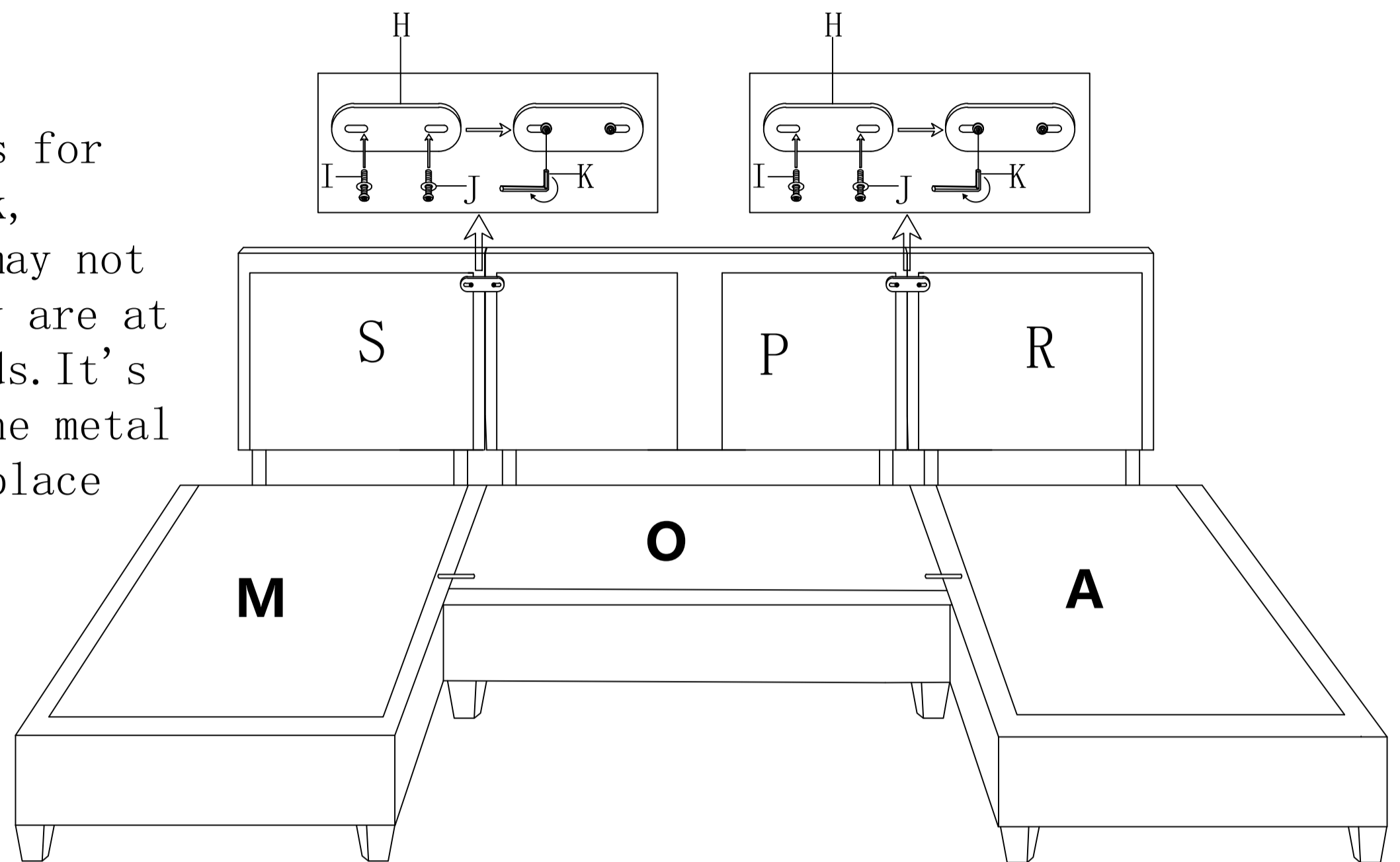

STEP8:

Stick the Velcro on the back cloth of the sofa under the seat frame

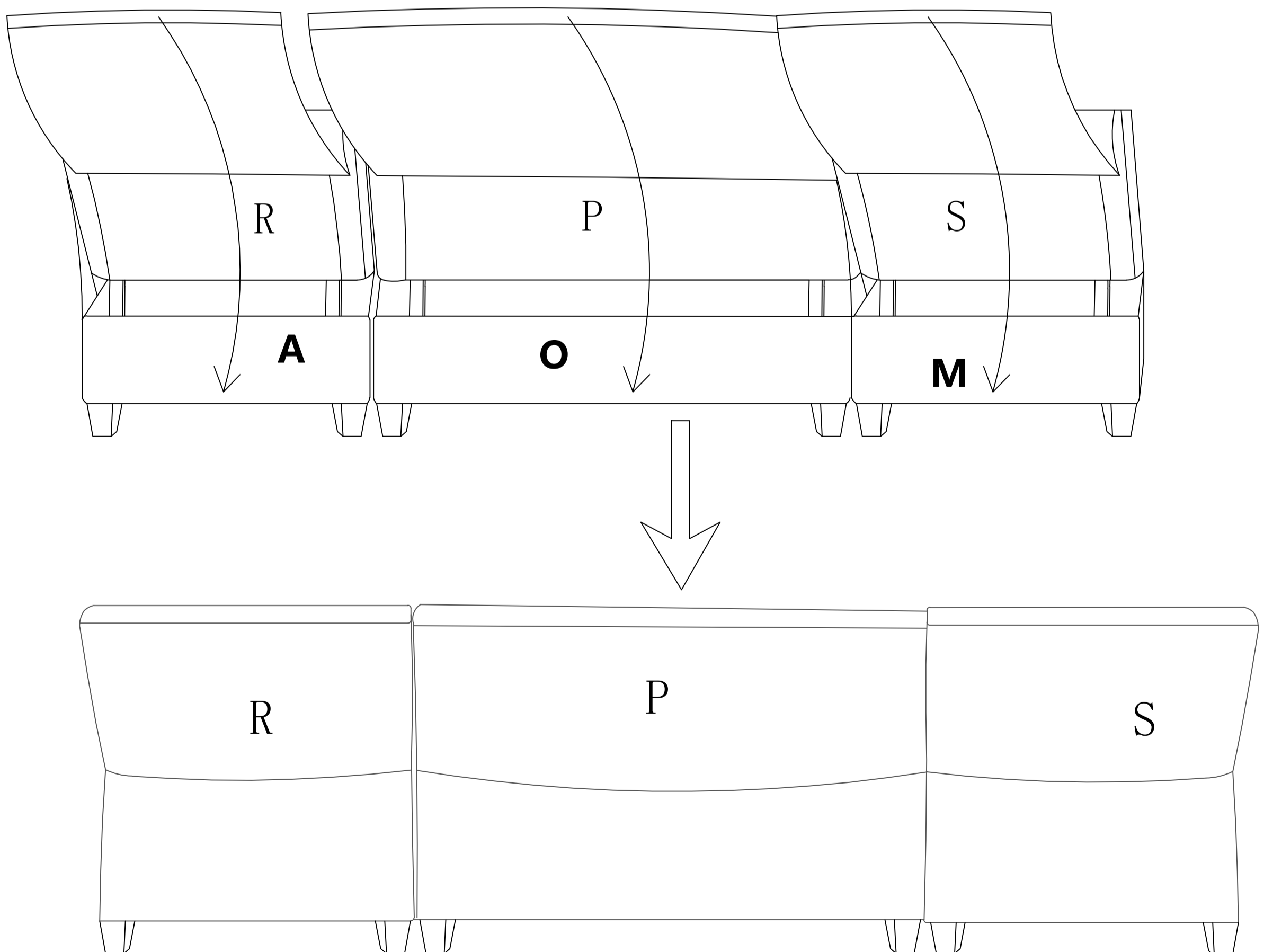

STEP9:

Cut off the compression bag and tear off the Velcro

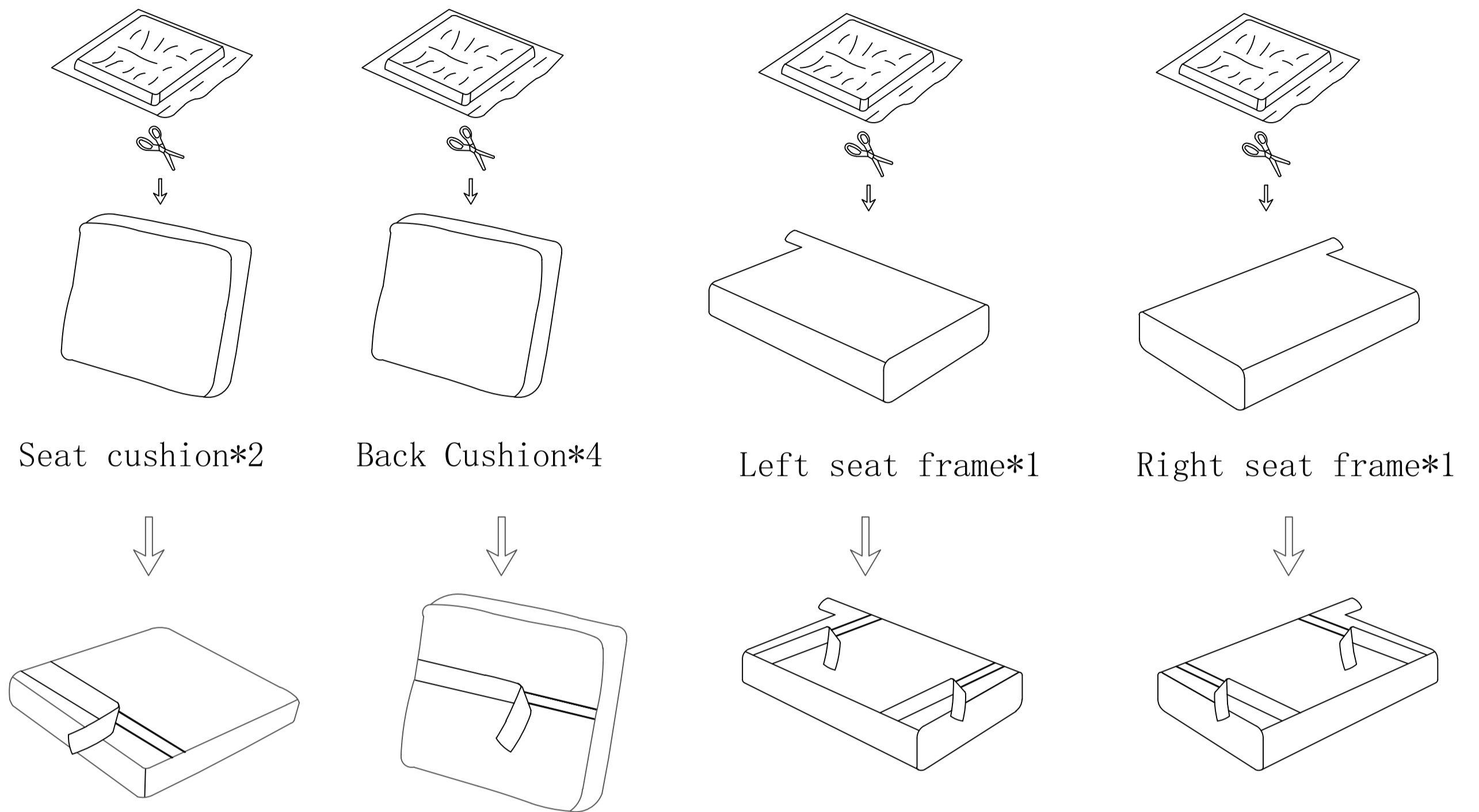

STEP10:

Zip the armrest pillows to the armrest

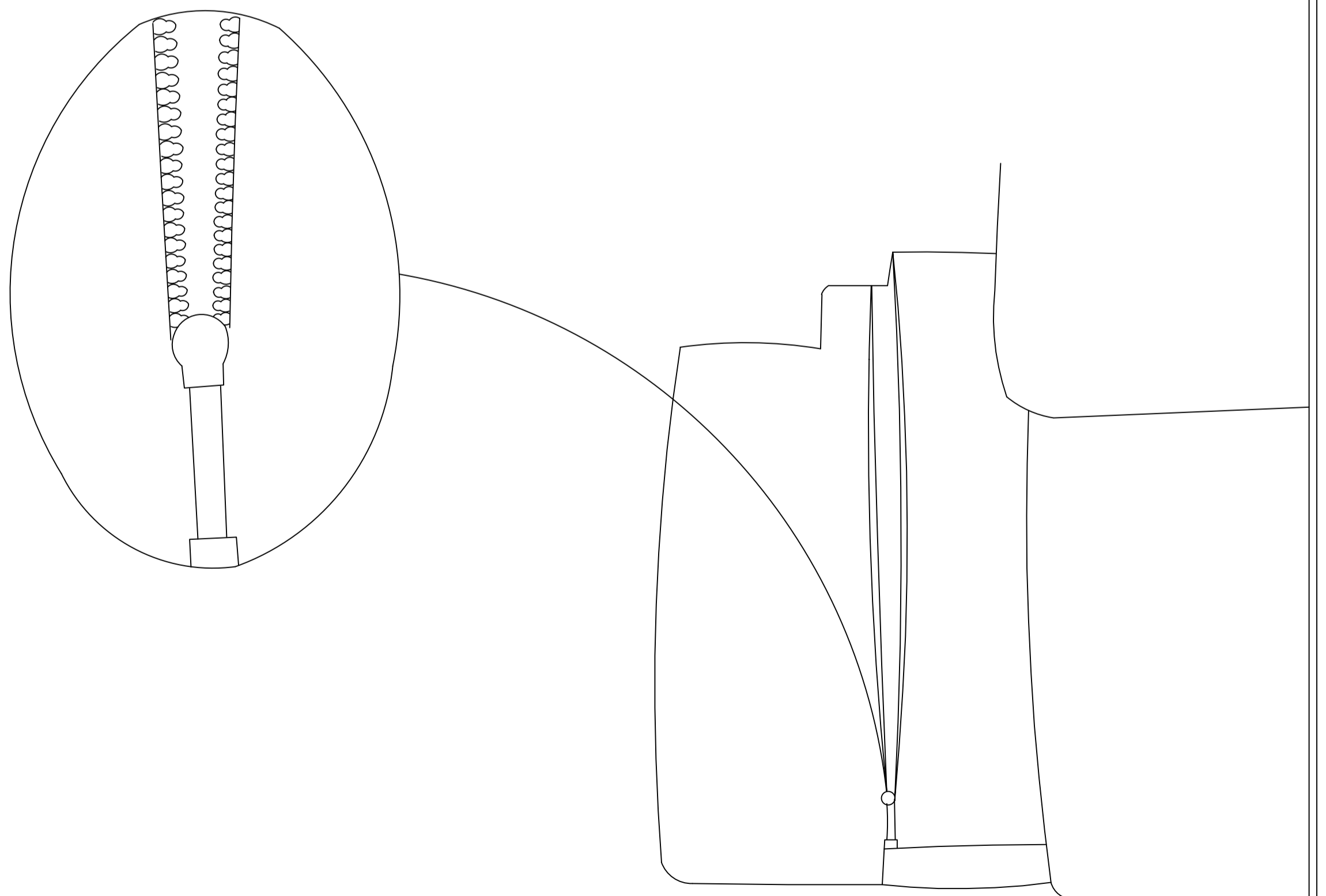

STEP11:

Assembly completed

