

## Warranty

We offer a one-year warranty for the light fixtures.

Our warranty ensures that any issues related to the performance or functionality of the light fixtures will be addressed and resolved promptly.

Our dedicated customer service team is available 24 hours a day to assist you. If you have any questions or concerns, we guarantee a response within 24 hours. During the warranty period, if you encounter any problems or need assistance, please don't hesitate to reach out to us via email. To ensure a swift and accurate resolution, kindly provide your order ID and detailed information regarding the issue.

**Important Note:** Please use this light fixture only for its intended purpose and avoid retrofitting or remodeling it. The warranty does not cover failures caused by third-party products or natural disasters.

## INSTALLATION INSTRUCTION

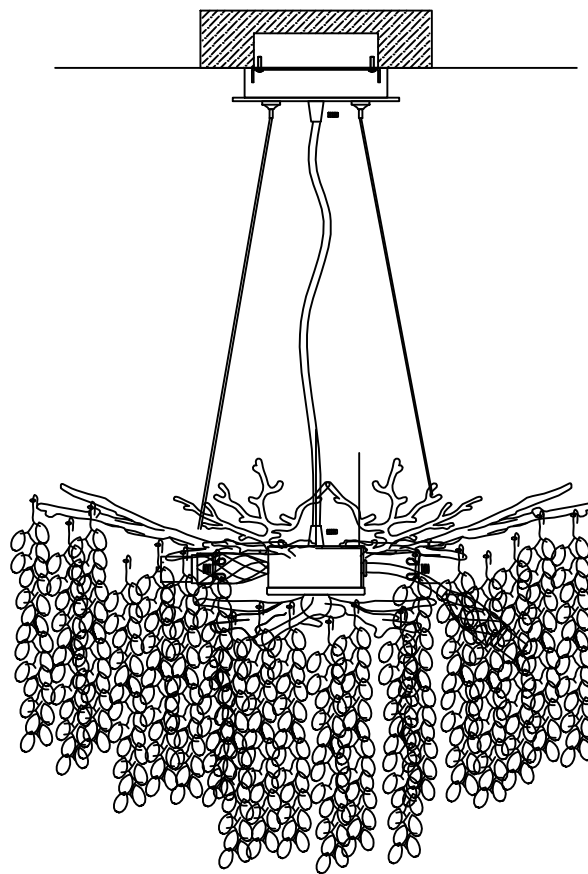

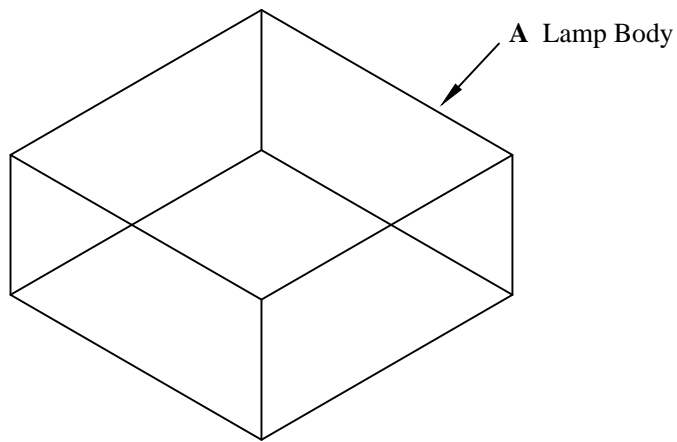

### **SAFETY INFORMATION**

It is important to thoroughly read and understand the entire manual, before assembling, operating, or installing the product,

### **WARNING**

- **TURN OFF ELECTRICITY** before installation, changing bulbs, or cleaning the light fixture.
- This fixture requires 8 pieces G9 bulbs(not included in the product, the maximum wattage for each bulb is 40W, please do not exceed the recommended wattage.
- **A QUALIFIED ELECTRICIAN IS RECOMMENDED FOR INSTALLATION.**
- Do not use corrosive substances such as gasoline or alcohol disinfectants to wipe the lamps, otherwise it will damage the lamps.

### **PREPARATION**

- Before installation, please make sure all the accessories are included (refer to the package content), if there is any part missing, please contact us at the order page, we will arrange the replacement in a timely manner
- 8 pieces of G9 bulbs(Max. 40W) are required(not included in the product)
- For any questions or inquires, please feel free to contact us at the order page, our customer service team will reply ASAP.

Please note:  
Please check the parts list, if the parts are missing during your actual installation, please contact us, we will help you in time!

# FINISHED PRODUCTS

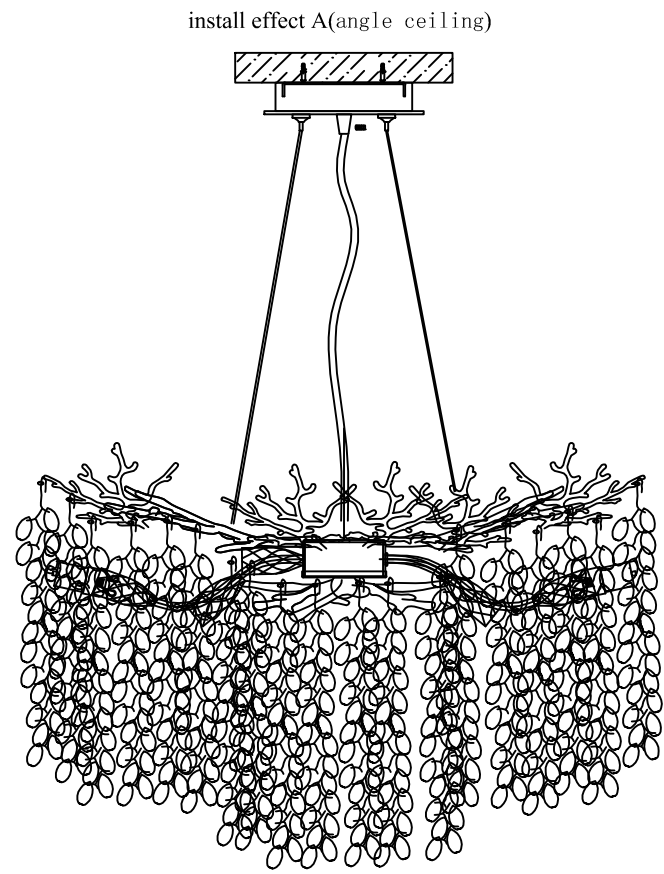

NOTES: Due to the handmade nature of the product, slight variations in dimensions may occur.

### Maintenance:

To ensure safe and efficient use of this product, please clean the lamp regularly (once a month). Before cleaning, turn off the power and wait for the lamp to cool to room temperature. Then use a soft cloth dipped in water and wrung dry to wipe it clean.

# PACKAGE CONTENTS

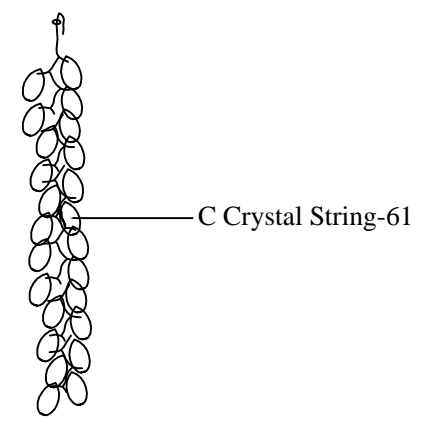
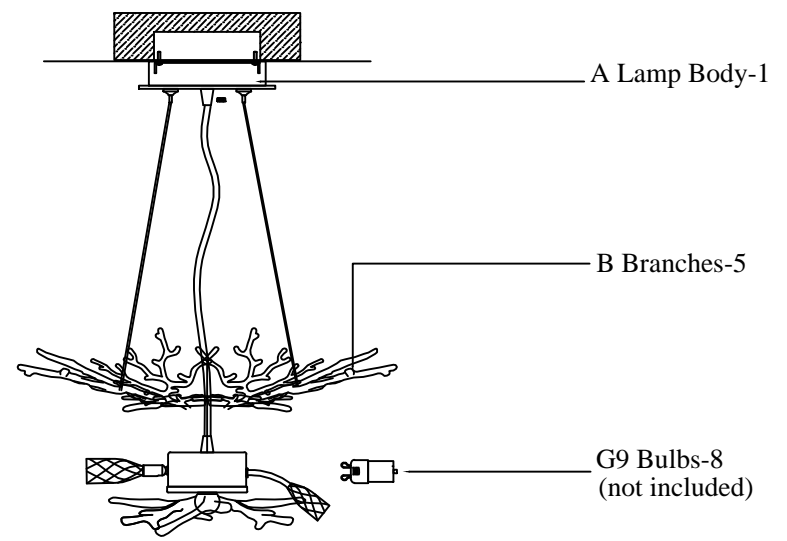
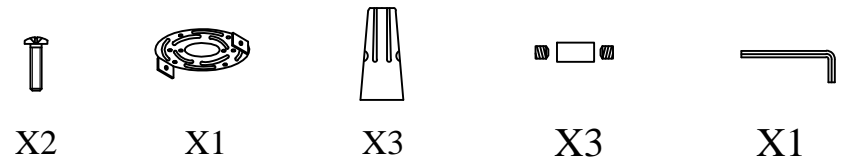

Please note:

Please check the parts list, if the parts are missing during your actual installation, please contact us, we will help you in time!

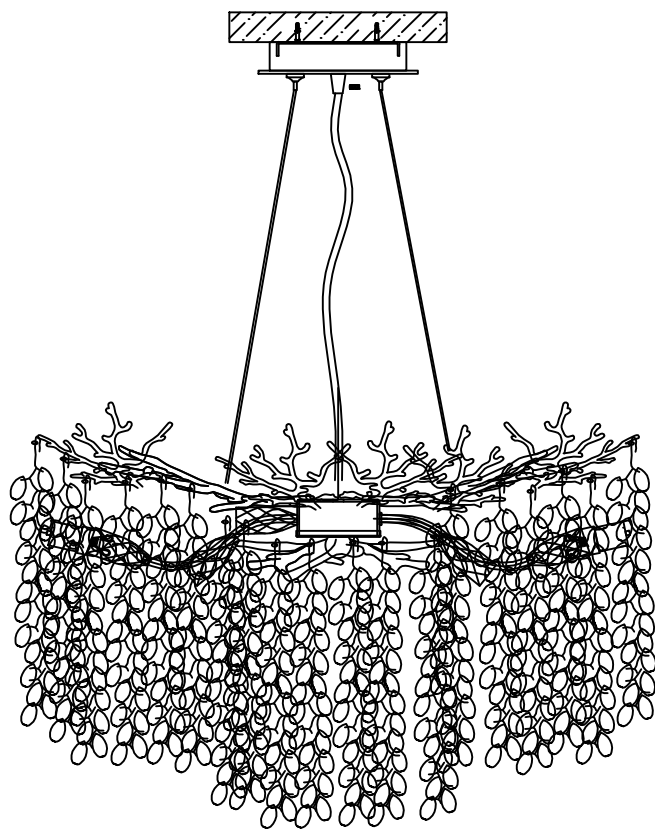

Steps:

1. Take out the lamp body and check the firmness of the lamp body;

## FINISHED PRODUCTS

install effect A (angle ceiling)

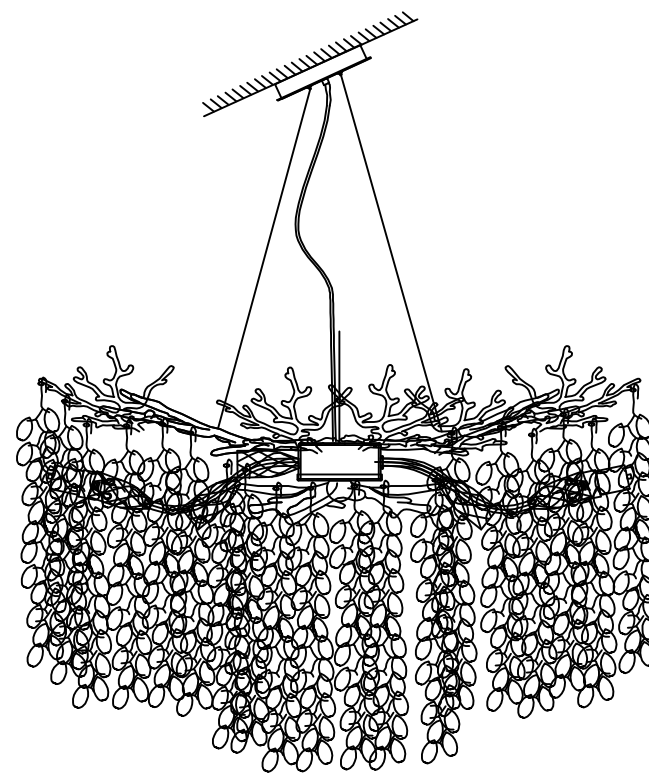

NOTES: Due to the handmade nature of the product, slight variations in dimensions may occur.

Cautions.

1. This lamp can only be used indoors;
2. TURN OFF THE POWER BEFORE THE INSTALLATION IS FINISHED.

# Installation instruction

4

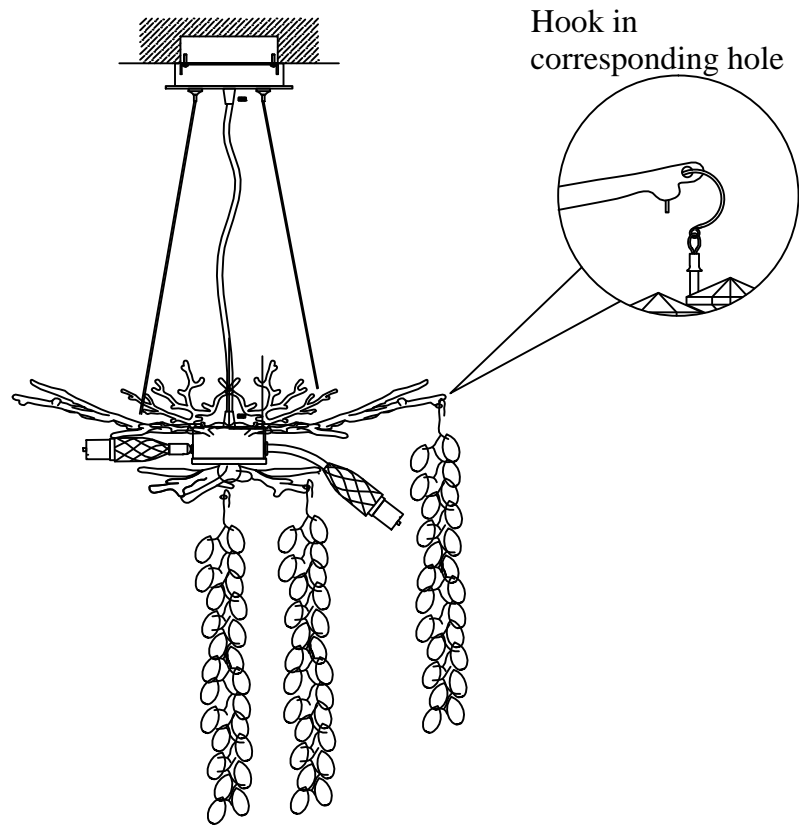

1. Fix the crystal string on the branches as the diagram.
2. Each branch should have 11 crystal strings, while the decorative branch at the bottom should have 6 crystal strings. The entire lamp should have 61 crystal strings.
3. When hanging the crystals, please try to keep them symmetrical to keep the balance for the light fixture.
4. The decorative branches are die-cast and have limited load-bearing capacity. The hanging accessories should not be changed without authorization, and no one should bear their weight during installation to avoid unnecessary safety accidents.

# Installation instruction

1

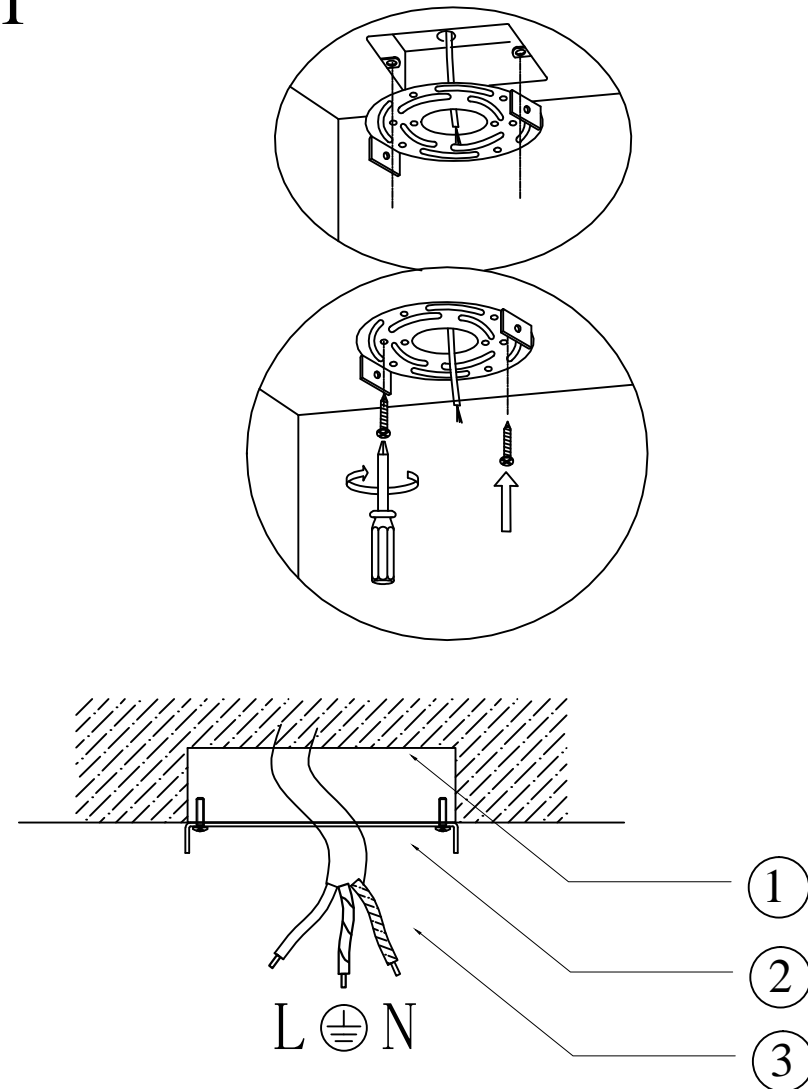

Steps:

1. Remove the crossbar from the preassembled mounting base.
2. Lock the crossbar on the junction box with the screw.

## Installation instruction

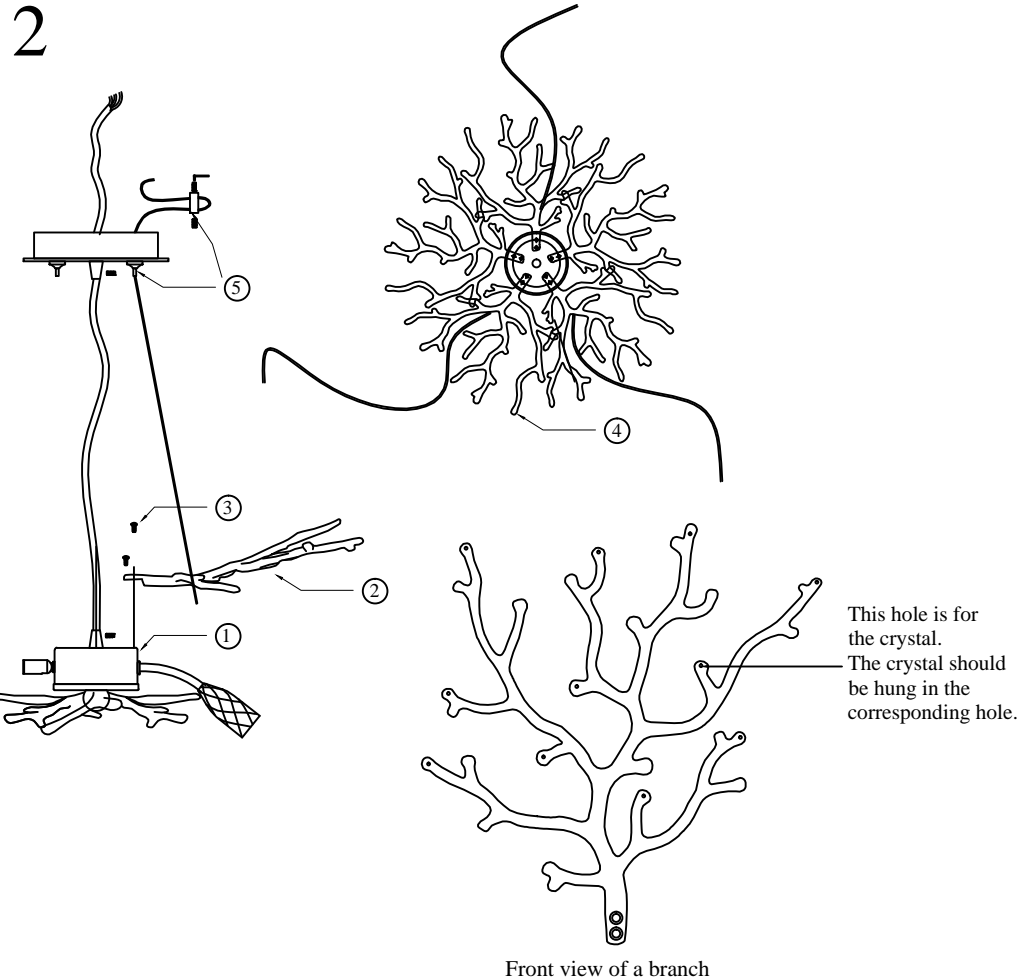

### Steps:

1. Take out the lamp body and check the firmness of the lamp body;
2. Take out the decorative branches
3. Use a cross screwdriver to remove the M4\*15mm screws on the lamp body in order, and install a set of decorative branches one by one, to avoid losing screws;
4. Install the branches with steel wire as the diagram, and thread the steel wire rope into the specified hole;
5. Install the steel wire on the pins on the ceiling plate, adjust the height, and lock the security pin behind the canopy (marked 5 on the diagram)

## Installation instruction

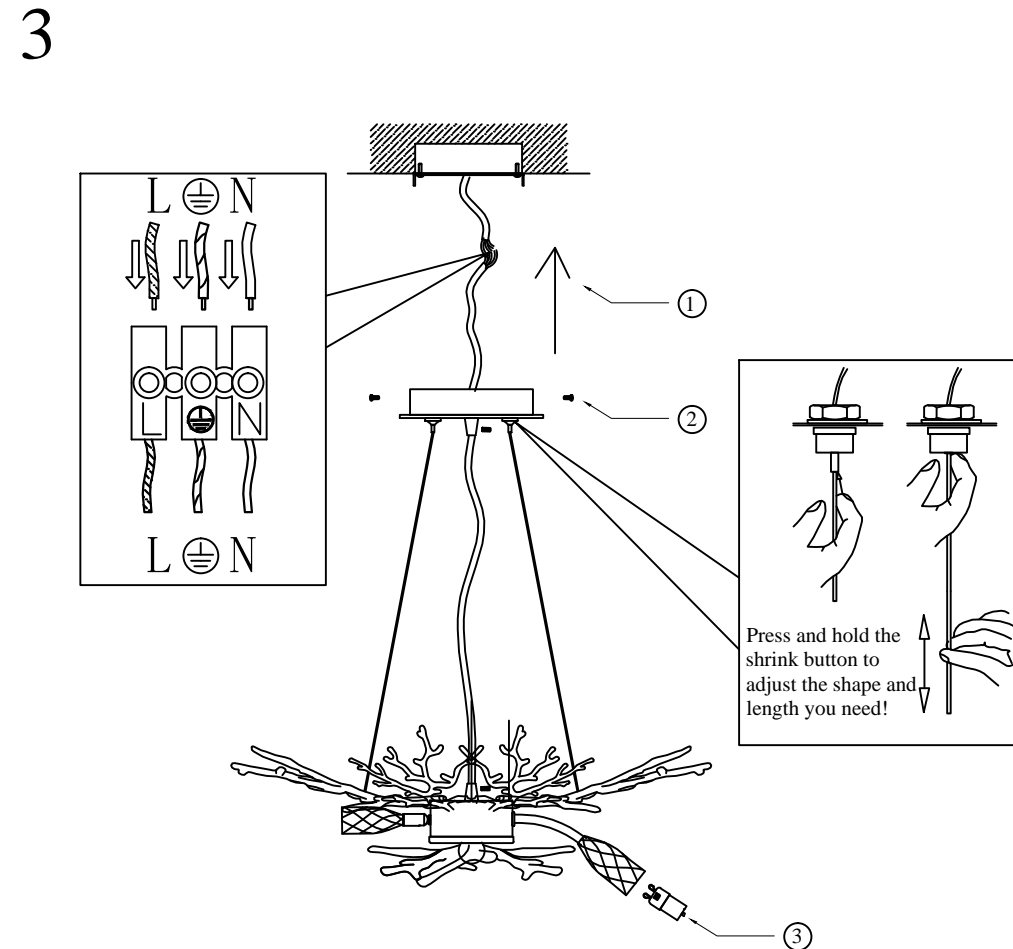

- ① Lift the installed lamp body to the bracket position and connect the wires, then lift it to align with the screw holes.
- ② Use the matching screws to tighten it.
- ③ Adjust the appropriate height of the lamp body according to the picture
- ④ Install the bulbs and test them.