

# Installing your **SCHWUNG** Armstrong Linear



Globe Collection

Armstrong Linear

2023

Our goal is to bring energy, warmth and pleasure into your personal space. It's great to be here.

Safety  
instructions 6

---

Components  
and features 7

---

Assembly  
instructions 9

---

Cleaning and  
maintenance 16

---

Troubleshooting 17

# Safety instructions



**We recommend installation  
by a licensed electrician.**

## **Safety instructions**

These instructions are provided for your safety. It is very important that they are read completely before beginning the installation of your fixture.

1. Turn off electricity at the main circuit breaker panel before beginning installation.
2. This direct wire fixture must be installed by a certified and licensed electrician. The customer should not attempt to install.
3. This fixture has been rated for up to 10 (G) 5W max 230V E12 base bulbs. To avoid the risk of fire, do not exceed the recommended wattage.
4. If any special control devices are used with this fixture, follow the instructions to assure full compliance with the N.E.C. requirements.
5. This fixture should only be used with a trailing edge dimmer.
6. Mounting hooks and wall anchors are not included. To select the proper type of mounting hook /wall anchor for your wall/ceiling please contact your local hardware store for assistance. If you have any questions, contact a licensed electrical contractor.

## **Warnings**

- Do not mount or unmount the glass globes if the fixture or light bulbs are hot.
- All wires are connected. Do not remove the ceiling light from its packaging by pulling on the power cord, as a bad connection may result.
- Do not use if the light cable/cord is damaged.
- To reduce the risk of fire, electrical shock or personal injury, always turn off the light fixture and allow it and the globes to cool prior to replacing light bulb.
- When mounting the fixture, always use the cotton gloves included.
- Do not touch bulb when fixture is turned on. Do not look directly at lit bulb.
- Keep flammable materials away from lit bulb.

# Components and features

## FEATURES

- Hand-crafted in brass
- Mouth-blown glass globes

## COMPONENTS

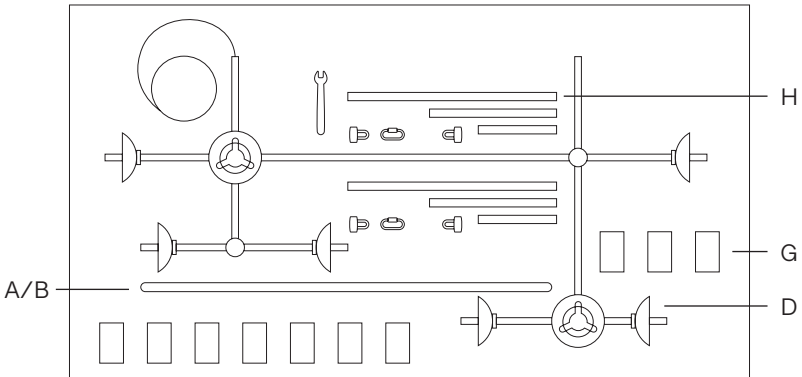
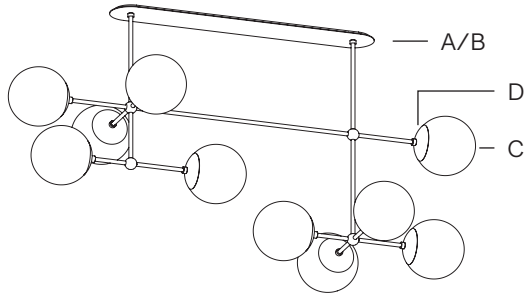

### Fixed Mount

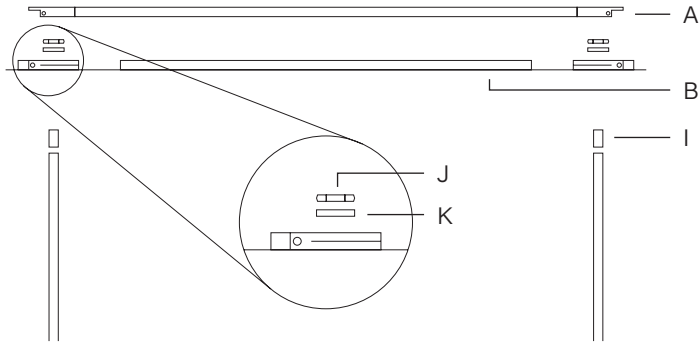

### Vaulted Ceiling Mount

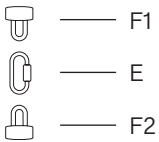

- A Top ceiling plate (1x)
- B Bottom ceiling plate (1x)
- C Glass globes (10x)
- D Globe caps (10x)
- E Quick-links (2x)
- F Loop nuts (4x)
- G 5W LED E12 bulbs (10x)
- H Extension rods (6x)
- I M10 nipples (2x)
- J M10 nuts (2x)
- K Washers (2x)

- Tools Enclosed:**  
Pair of cotton gloves  
Wrench  
Allen key

- Not Included**  
(recommended for installation):  
Wall anchors  
Screw  
Electric drill

# Assembly instructions



Make sure you cut off power supply at the main fuse box/circuit breaker before commencing any work.

1

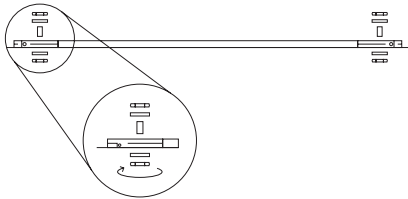

Take out the top ceiling plate from the box and unscrew the safety nuts and washers on the bottom side of the plate.

**NOTE:** Keep the washer, nut and nipples [1] for the future. The following steps are for the fixed mount. If you want to install a vaulted ceiling system, please go to step 18.

2

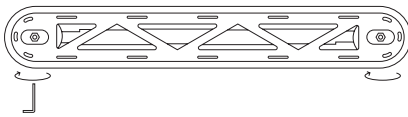

Use the included allen key to unscrew the lock screws on the top ceiling plate and slide the top ceiling plate to detach it from the bottom plate.

3

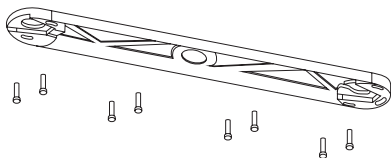

Place the plate against the ceiling and mark spots for anchors and drill the holes. Mount the plate to the ceiling

**NOTE:** The position of the ceiling plate determines the position of the fixture, please plan carefully taking into account power supply wires.

4

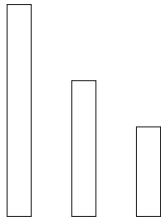

Are you installing extension rods?

**YES: Continue to Step 5**

**NO: Jump to Step 6**

5

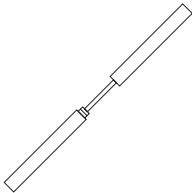

Carefully pull the cord through selected extension rods [H] and screw them on. Repeat for the other vertical rod without the electrical cord.

6



The nipples [I] which were used for the safety nuts, must be screwed into the vertical rods. Make sure the electrical cord is not damaged in the process.

**NOTE: The following steps are for the fixed mount. If you want to install a vaulted ceiling system, please go to step 18.**

7

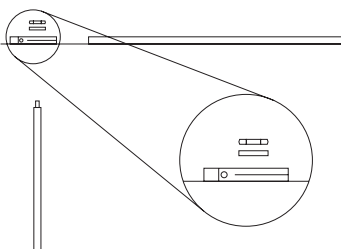

Place the bottom ceiling plate onto the rods and use the nuts [J] and washers [K] to connect and secure the parts.

8

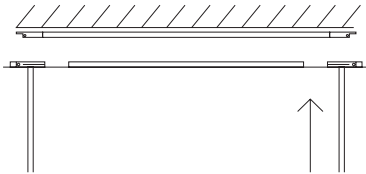

Lift the fixture up to the ceiling and make necessary electrical connections.

**NOTE:** Two people are needed for this and the three following steps.

9

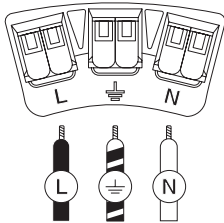

Use the included terminals to connect the wires and place the terminal holder flat in the ceiling plate.

**NOTE:** We recommend installation by a licensed electrician.

10

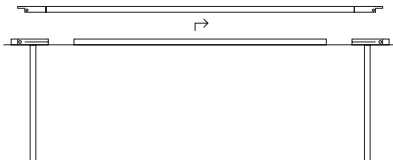

Slide the fixture into position on the top ceiling plate.

**NOTE:** Make sure the wires are not squeezed between the parts.

11



Use the included allen key to screw in the lock screws to secure the 2 ceiling plates.

12

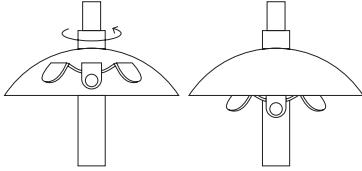

To start mounting the glass globes, turn the cap on the selected arm counterclockwise until it stops. Follow steps 15-19 for each arm.

13

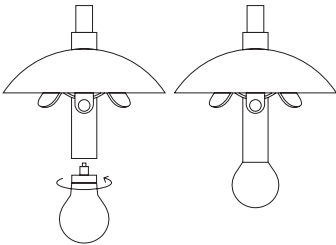

Insert the 10 5W LED E12 bulbs.

14

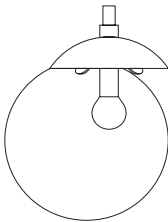

Place the globe opening on one of the clamps and slide it on as far as possible. Repeat the same movement for one more clamp.

**NOTE:** Included cotton gloves must be worn when handling glass globes.

15

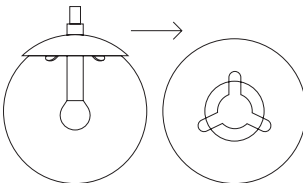

Tilt and slide the globe as in the drawing to hang it on the last clamp.

16

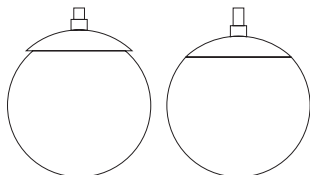

Turn the cap clockwise to secure the globe in position. Repeat for each arm/globe.

17

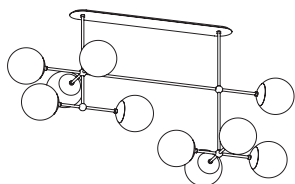

Restore power and enjoy your Schwung Lamp.

### VAULTED CEILING SET UP

---

18



Use the loop nut [F2] and screw it into the vertical rods.

19

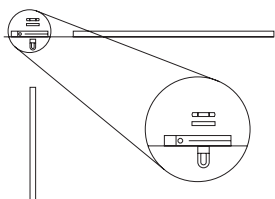

Use the other loop nuts [F1], the nuts [K] and washers [L] to connect and secure the parts on the bottom ceiling plate.

---

20



Connect the 2 loop nuts with a quick-link on each rod and slide the cord through the loops and the ceiling plate.

**NOTE:** Go back to step 8 to complete the installation

---

# Cleaning and maintenance



Make sure you cut off power supply to the lamp before commencing cleaning operations.

Components	Maintenance	Tools
Brass Frame	Clean every month using a soft cloth, dampened slightly with water. Make sure the frame is dry before switching the lamp back on.	Soft cloth, water
Glass globes	Clean regularly with a soft dry cloth. Clean only the outside of the globe. If especially dirty, use a wet cloth first. Grease can be removed with a gentle glass cleaner.	Soft cloth, Cotton gloves (!)
Light bulbs	Make sure your power supply is off before changing the bulb. Unscrew the globe where bulb needs replacing. Gently remove the bulb by pulling it out and replace with a LED bulb of the same parameters.	LED bulbs, Cotton gloves (!)

**NOTE:** Please remember, solid brass may tarnish over time. This is a natural process. Make sure you follow our guidelines to preserve the great look of Schwung lighting for years.

# Troubleshooting

Problem	Possible Cause	Action
Tarnishing	Oxidation of brass is a natural process. Although it is lacquered, its color may change slightly over time.	No action is necessary apart from regular cleaning. See the Maintenance section.
Globe deformations	Mouth-formed glass globes are beautiful but not perfect. The process leaves a slight deformation at the bottom of the globe.	No action is necessary. All globes undergo a quality check. Should you have any doubts, please send us a photo of the deformed globe and we will act accordingly.

**NOTE:** Dear client, please be assured our team strives to deliver highest quality products. The handmade nature of the products offers a unique aesthetic experience and allows for small imperfections, which is inherent in crafts. If solutions offered below are not sufficient, please do not hesitate and contact our customer service.

# Having trouble?

We're sorry to hear that.

Our enlightened objects are designed for longevity.

Each piece is made by hand to ensure the highest possible quality and a unique aesthetic experience.

This means you may encounter small surface imperfections. We like to think of them as whispered greetings from our craftspeople. But should you have any concerns about your product and the previous solutions fail to help, please don't hesitate to email us at [info@schwung.design](mailto:info@schwung.design)