

BOSSCARE

Deluxe Massage Chair

GR8286

BOSSCARE

U S E R M A N U A L

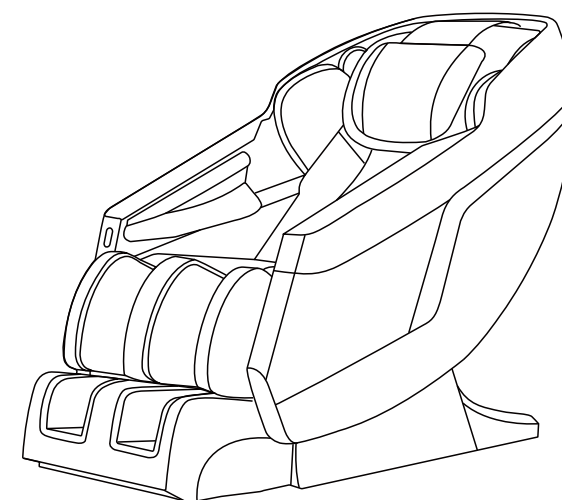

Thank you for choosing our product and your support. In order to understand the directions fully, please read user's manual carefully. And after reading, please keep it for next browsing. We reserve the right of final explanation to the design of product. Dimensions and specifications are subject to change without notice for further improvement.

Contents

Safety	1-6
Preparation Before Use	7-9
Move the Chair	7
Place the Chair	7
Install Legrest	8
Install Backrest Pad and Pillow Pad	9
Connect Power	9
Components	10-14
Outer Structure	10
Controller	11
Function of Controller	12-14
Cleaning and Maintenance	15
Troubleshoot	16
Specifications	17

IMPORTANT SAFETY INSTRUCTIONS

This massage chair is intended for household only. When using an electrical appliance, basic precautions should always be followed, including the following:

Read all instructions before using this massage chair.

DANGER-To reduce the risk of electric shock:

- 1) Always unplug this appliance from the electrical outlet immediately after using and before cleaning.
- 2) Never use pins or other metallic fasteners with this appliance.
- 3) Carefully examine the covering before each use. Discard the appliance if the covering shows any sign of deterioration, such as checking, blistering, or cracking.
- 4) Keep Dry - Do not operate in a wet or moist condition.

WARNING-To reduce the risk of burns, fire, electric shock, or injury to persons:

- 1) An appliance should never be left unattended when plugged in. Unplug from outlet when not in use, and before putting on or taking off parts.
- 2) Do not operate under blanket or pillow. Excessive heating can occur and cause fire, electric shock, or injury to persons.
- 3) Close supervision is necessary when this appliance is used by, on, or near children, invalids, or disabled persons. Keep children away from extended foot support.
- 4) Use this appliance only for its intended use as described in this manual. Do not use attachments not recommended by the manufacturer.
- 5) Never operate this appliance if it has a damaged cord or plug, if it is not working properly, if it has been dropped or damaged, or dropped into water.
Return the appliance to a service center for examination and repair.
- 6) Do not carry this appliance by supply cord or use cord as a handle.
- 7) Keep the cord away from heated surfaces.
- 8) Never operate the appliance with the air openings blocked. Keep the air openings free of lint, hair, and the like.
- 9) Never drop or insert any object into any opening.

- 10) Do not use outdoors.
- 11) Do not operate where aerosol (spray) products are being used or where oxygen is being administered.
- 12) To disconnect, turn all controls to the off position, then remove plug from outlet.
- 13) Temperatures sufficiently high to cause burns may occur regardless of the control setting. Do not use on an infant or invalid or on a sleeping or unconscious person. Do not use on insensitive skin or on a person with poor blood circulation. Check the skin in contact with the heated area of the appliance frequently to reduce the risk of blistering.
- 14) Do Not Crush - Avoid sharp folds.
- 15) Do not use massager in close proximity to loose clothing or jewelry.
- 16) Keep long hair away from massager while in use.
- 17) Connect this appliance to a properly grounded outlet only. See Grounding Instructions.
- 18) The apparatus shall not be exposed to dripping or splashing and that no objects filled with liquids, such as vases, shall be placed on the apparatus.
- 19) An apparatus with CLASS I construction shall be connected to a MAINS socket outlet with a protective earthing connection
- 20) The appliance coupler is used as the disconnect device, the disconnect device shall remain readily operable.
- 21) This appliance is not intended for use by persons (including children) with reduced physical, sensory or mental capabilities, or lack of experience and knowledge, unless they have been given supervision or instruction concerning use of the appliance by a person responsible for their safety.
- 22) If it is not in use for a long time or after use, please turn off the power and pull out the power plug.
- 23) Do not damage, break, over-bend, compress, tighten, wind, rotate or knot the power cord.
- 24) This appliance can be used by children aged from 8 years and above and persons with reduced physical, sensory or mental capabilities or lack of experience and knowledge if they have been given supervision or instruction concerning use of the appliance in a safe way and understand the hazards involved. Children shall not play with the appliance. Cleaning and user maintenance shall not be made by children without supervision.

SAVE THESE INSTRUCTIONS

This massage chair is intended for household use only.

● Usage Environment

- Do not use the massage chair in an excessively humid or dusty environment as this may result in malfunction or electric shock.
- Do not use the massage chair in a room with a temperature of 104°F or higher.
- Do not expose the massage chair to heaters, stoves or direct sunlight.
- Place and use the massage chair on an even, non-slip floor.
- The massage chair is designed for home use and not for commercial purposes.

Caution

- The massage chair is to be used indoors only.
- If you use the massage chair in a cold room, do not increase the room temperature abruptly. It is recommended that you increase the temperature gradually to a normal level.
- If the massage chair is stored in a cold place and is being brought into a warm environment, it is advisable to wait one hour before use. This is because its performance may not be at optimum level, as there may be water droplets on the mechanical parts due to condensation. Using the massage chair under such conditions may result in malfunction.

IMPORTANT SAFETY INSTRUCTIONS

● Safety Precautions

- To ensure safe and correct use of the massage chair, do not operate it without reading this operation manual carefully.
- Do not use the massage chair when the upholstery or seat is removed. This may cause injury or malfunction.
- Do not use the massage chair in combination with other therapeutic equipment or electric blanket, etc., as this may result in ineffectiveness or injury.
- Do not use the massage chair an hour before or after eating as this may have adverse effects on the user.
- Do not allow children or pets to play around the massage chair, e.g., behind the backrest, under the seat or leg rest of the massage chair. This may result in injury.

- Do not rest or place heavy objects on the armrests, leg rest or backrest as this may result in malfunction or injury.
- Do not use the massage chair when your body is wet.
- Do not operate the massage chair with wet hands.
It is not recommended to use the massage for more than 30 minutes.
- Do not perform continuous massage on the same spot of your body for more than 5 minutes at a time as this may result in excessive stimulation and may have adverse effects.
- Do not insert your hand or foot along the paths of the massage rollers during use as this may cause injury.
- Stop operation immediately if you experience any discomfort.
- This product is not intended for self-treatment of conditions that should be managed by a qualified health care provider.
- People on medication or with medical conditions, please consult your doctor before use.
- Please do not use the product if you are not feeling well.
- Remove all scarves, neckties, necklaces and jewelry before using the massager.

● People with Medical Conditions

Consult your doctor before use if you:

- are under medical rest as ordered by a doctor.
- have spinal disorders, an abnormal spinal condition or have suffered a spinal injury.
- have back problems.
- have diabetes, osteoporosis or sensory impairment.
- have joint dysfunction.
- have a pacemaker or other electronic medical devices.
- may be pregnant.
- have phlebitis or thrombosis.
- have an increased risk for blood clots.
- had recent surgery.
- have surgical pins, screws, or anything mechanical implanted in your body.

Safety

● Instances When the massage chair Should Not Be Used

In the following events, please switch off the main power switch immediately and disconnect the power cord from the electrical outlet:

- If water is accidentally spilled onto the massage chair. This may result in electric shock or malfunction.
- If the fabric of the backrest is torn and the internal components are exposed.
- If pain or discomfort is felt during massage, stop operation immediately and consult your doctor.
- If you detect any malfunction or any other abnormal condition during operation.
- If there is a power failure. Injury may occur when power is restored unexpectedly.
- If there is lightning.

● Assembly and Repair of the massage chair

- Do not disassemble the backrest cover of the massage chair. Touching the internal components may result in malfunction or electric shock.
- The massage chair must only be professionally serviced or repaired. Do not attempt to disassemble or repair the massage chair yourself.

● Things to Note About the Power Plug and Cord

- Check that the Alternating Current (AC) voltage corresponds with the specifications indicated for the massage chair.
- Do not connect or disconnect the power plug from the electrical outlet with wet hands. This may result in malfunction or electric shock.
- When disconnecting the power plug, pull it by holding the plug, not the cord.
- Although operation will be stopped automatically by the Auto-Timer function, always remember to switch off the main power switch after use.
- Do not place the power cord under the massage chair or any other heavy objects.
- Do not wind the power cord around the massage chair as this may damage the cord and result in a fire or electric shock.
- Do not operate the massage chair with a damaged cord or extension cord.
- Do not use the massage chair if the electrical outlet is loose.
- If the power cord is damaged, it should be replaced by a qualified technician.

Safety

● Grounding Instructions

This product must be grounded. If it should malfunction or breakdown, grounding provides a path of least resistance for electric current to reduce the risk of electric shock. This product is equipped with a cord having an equipment-grounding conductor and a grounding plug. The plug must be plugged into an appropriate outlet that is properly installed and grounded in accordance with all local codes and ordinances.

DANGER - Improper connection of the equipment-grounding conductor can result in a risk of electric shock. Check with a qualified electrician or serviceman if you are in doubt as to whether the product is properly grounded. Do not modify the plug provided with the product - if it will not fit the outlet, have a proper outlet installed by a qualified electrician.

This product is for use on a nominal 120V~ circuit and has a grounding plug that looks like the plug illustrated in sketch A as following illustration. Make sure that the product is connected to an outlet having the same configuration as the plug. No adapter should be used with this product.

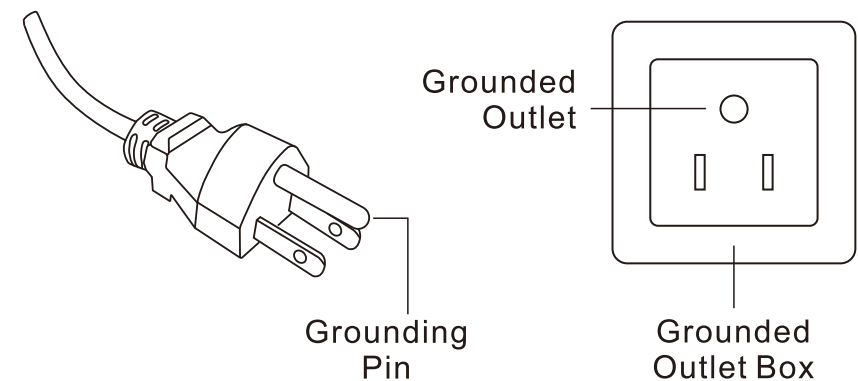

Preparation Before Use

Move the Chair

- Please turn off the main power and unplug the power from the electrical outlet.
- Tilt the chair backward as shown in the picture below and wheel it to the desired location.
- Please cover the floor with mat when move the massage chair in case of any damage of floor will be made.

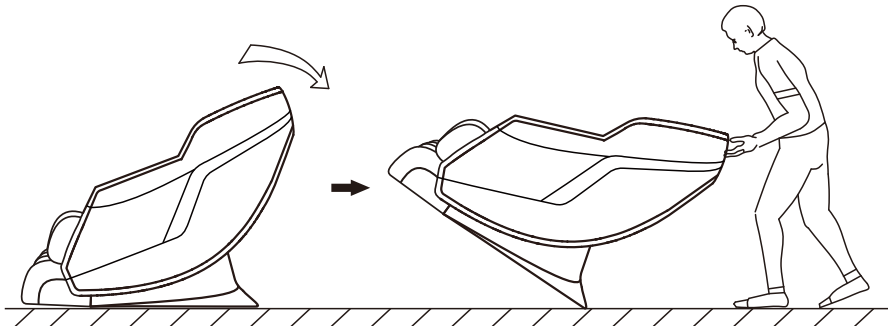

Place the Chair

Please make sure that there is an allowance of more than 50cm behind the massage chair, and more than 50cm in front of the massage chair to allow the backrest to recline without obstruction during operation.

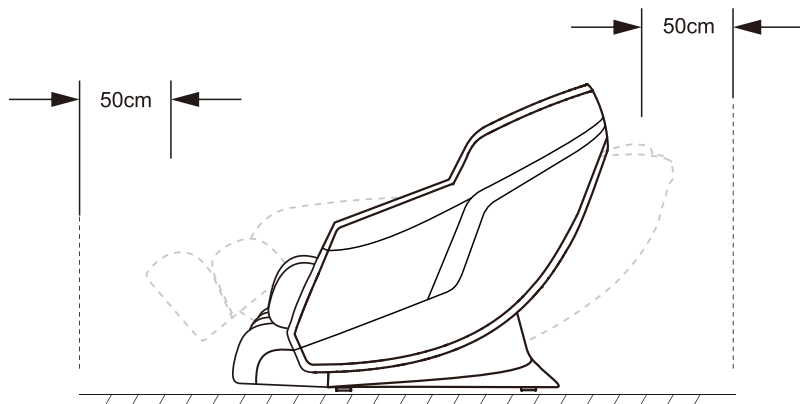

Preparation Before Use

Installation

1. Remove Chair and all Parts from their Packaging

- ▶ Remove any protective wrapping. Check to make sure that all parts are present.

2. Installing the Legrest

- ▶ Take the nuts and bolts from the accessories bag.
- ▶ Align the screws "E" at screw holes "A" and "B", and tighten the screws.

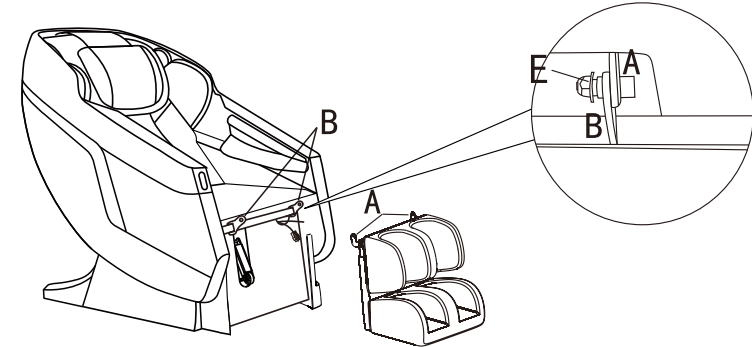

- ▶ Lift the Legrest by reclining the chair. Turn off the power switch and remove the power cord. Attach the corresponding connectors to the ports located on the back of the Legrest.

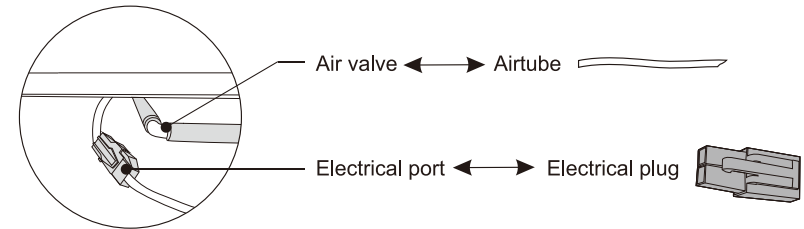

3. Install Cushion

- ▶ Prepare the seat cushion and put it in the chair (the air hose faces inward).
- ▶ Connect the cushion air hose to air hose in the seat frame

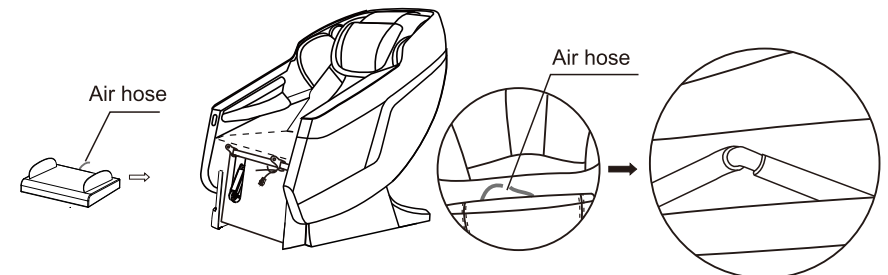

Preparation Before Use

- ▶ Connect the wire of the heater plug from the backrest to underneath of the seat (Fig2)
- ▶ Connect the backrest and the seat by zipper. (Fig 3)

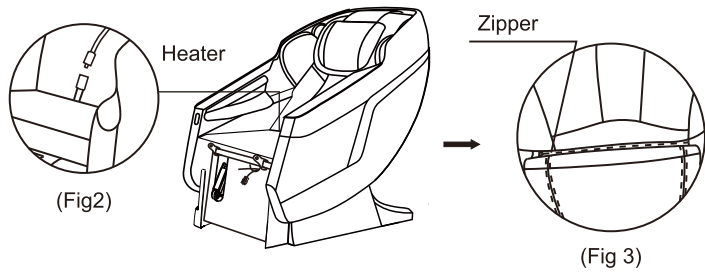

4. Install Backrest Pad and Pillow Pad

- ▶ Attach the upper backrest pad to the backrest with zipper.
- ▶ Remove the cloth on the velcro, then attach the pillow and backrest with velcro.

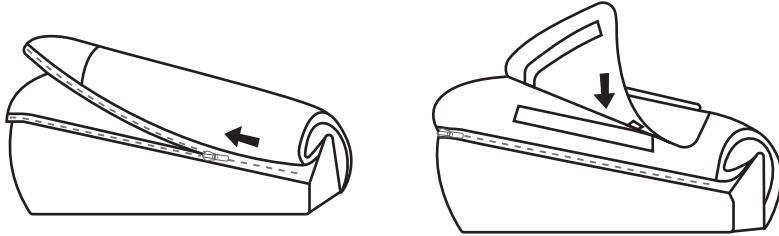

5. Power Supply

- ▶ After all parts are assembled, please insert the power cord into the power socket, and then turn on the switch.
- ▶ Press the power button on the remote to start massage.

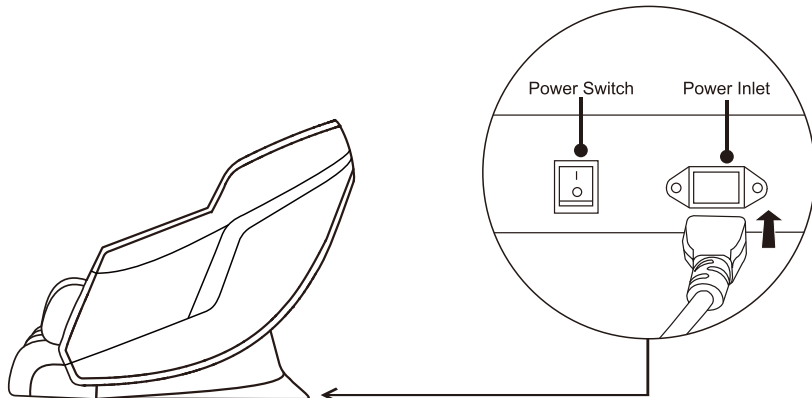

Components

Outer Structure

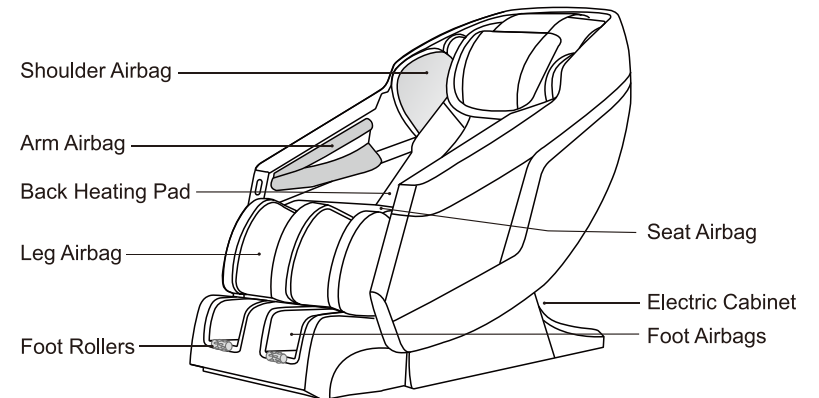
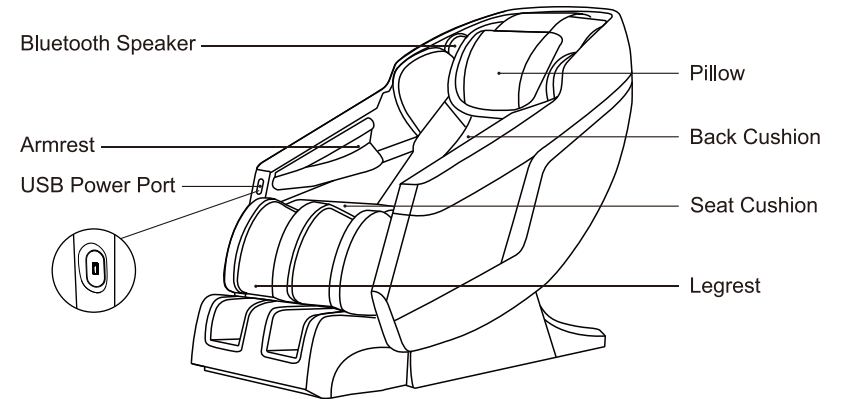

Components

Controller

(The specific display is subject to the actual product.)

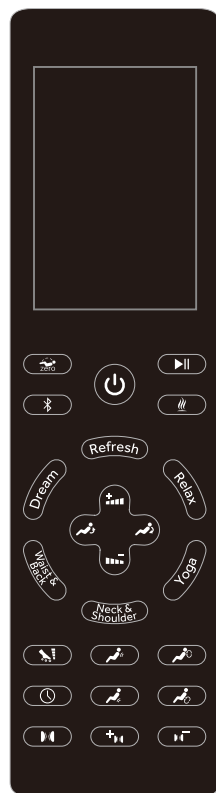

















Caution



- Do not sit, step or place heavy objects on the controller.
- Do not drop the controller. It is recommended that the controller unit be placed in the controller side pocket when not in use.
- Do not exert excessive force on the controller.
- Do not handle the controller with wet hands.
- Do not operate the controller by using sharp-edged or hard objects. It may result in damage.

Components

Function of controller

FUNCTION	ICON	DESCRIPTION
Power		When the power is on, press this button to turn on the massage chair, and then press this button again to turn off.
Zero-G		Press this button to to turn on, switch and turn off Zero-G function successively.
Pause		Press this button to pause all massage functions of the whole machine, and then press again to resume massage.
Bluetooth		Press this button to turn on/off the function
Heat		Press this button once to turn on the heating function, and the screen shows []. Press again to turn off the heating function, and the icon goes out.
Intensity + / Intensity -		Press this button (+) to increase the massage intensity.
		Press this button (-) to decrease the massage intensity.
Back Up / Back Down		Long press this button to adjust the up of the backrest, and release the button to lock the current angle of the backrest.
		Long press this button to adjust the down of the backrest, and release the button to lock the current angle of the backrest.
Rollers		Press this button to turn on/off the roller massage function and switch the roller intensity.
Neck & Shoulder		Press this button to turn on/off massage rollers on the shoulder and neck.
		Under the above neck and shoulder mode, press this button to switch rollers between clockwise and counter-clockwise.
Timing		Press this button to set the massage time. The selected time is 15/20/25/30 minutes.
Waist & Back		Press this button to turn on/off massage rollers on the waist and back.
		Under the above waist and back mode, press this button to switch rollers between clockwise and counter-clockwise.

Components

Airbag		Press the button to switch or turn off the airbags function on shoulder, arm, hip, calf and feet.
Airbag Intensity		Press this button to increase the airbag intensity.
		Press this button to decrease the airbag intensity.

Auto Mode

FUNCTION	DESCRIPTION
Refresh	Master mode, full body massage, the intensity of roller and airbag massage is stronger.
Relax	Relaxing mode, full body massage, medium intensity for roller and airbag massage.
Yoga	Full body massage, like Yoga exercise.
Neck & Shoulder	Partial massage, focus on improving neck pain and shoulder muscle strain, the roller is focusing more on the neck and shoulder massage.
Waist & Back	Partial massage, focus on the waist and back massage to improve back pain, the roller is focusing more on the waist back massage.
Dream	Full body massage, light intensity for roller.

Bluetooth pairing

On your phone Bluetooth list, choose the model GR8286 to do the pairing, when a sound 'du' is heard, the connection is completed.

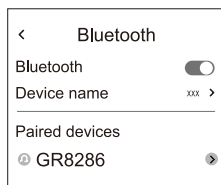

Cleaning and Maintenance

1. Storing the massage Chair

- With a dry, soft, clean cloth after use.
- Keep the massage chair clean and away from places of high humidity.
- If the massage is not to be used for a long period of time, cover the massage chair with dust cover and unplug its power plug from the electrical outlet.

Caution

- Do not store the massage chair in direct sunlight or in places of high temperature. This may cause the color of the upholstery to fade.
- Do not allow the massage chair remain in contact with vinyl or wallpaper for extended periods of time as this could lead to discoloration.

2. Cleaning the Massage Chair

- Before cleaning, ensure that the main power switch is off and the power plug is disconnected from the electrical outlet.
- Wipe off dust and dirt from the massage with a dry, soft, clean cloth after each use.
- This product can be cleaned thoroughly with a slightly damp cloth.
- Do not iron the upholstery.
- Do not wash the upholstery using a home washing machine as this may result in deterioration of the upholstery's quality.

Caution

- Do not use abrasive cleaning agents like benzene or thinner to the massage chair. This may cause the upholstery to fade.

3. Cleaning the Controller

- Use only a clean, dry cloth to clean the controller.

Caution

- Do not use a wet cloth to clean the controller, This may result in malfunction.

Troubleshoot

If there is still an abnormality after the following checks, to prevent any accident, please stop using the massage chair immediately. Please unplug the power cord from the outlet and contact with the dealer or the nearby customer service center.

Situations	Solutions
The Massage Chair cannot operate even though it has been connected to the power supply.	<ul style="list-style-type: none"> • Check whether the plug is well connected and working well • Check whether the switch on the Massage Chair is turned to position " I ".
During operation, the controller is working but not the Massage Chair.	<ul style="list-style-type: none"> • The Massage Chair could be overheated after prolonged use. It will automatically cool down to resume its normal condition. Please turn OFF the power and allow the chair to cool down for 30 to 50minutes.
During operation, both the controller and the Massage Chair are not working.	<ul style="list-style-type: none"> • If the set-time in the Timer is complete, please press the timer function again to resume operation. • Switch OFF power, and switch ON again to activate the Chair.

Warranty & Customer Support

If you need help regarding product issues, after-sales service, or other relevant problems, please contact us via email.

Email: bosscares01@outlook.com

Please have the following information ready when requesting for service:

- Order ID
- Problem Description (pictures and video)
- Serial number on the electric cabinet

*Note: Products purchased directly from bosscares benefit from our after-sales service. If the purchases are made from other selling teams, we recommend you contact them for warranty issues.

Specifications

Model	GR8286
Rated Voltage	120V~
Rated Frequency	60Hz
Rated Power	100W
Upright position-Approximately	1360*745*1046mm
Reclined position-Appr	1656*745*640mm

