

Assembly Instructions

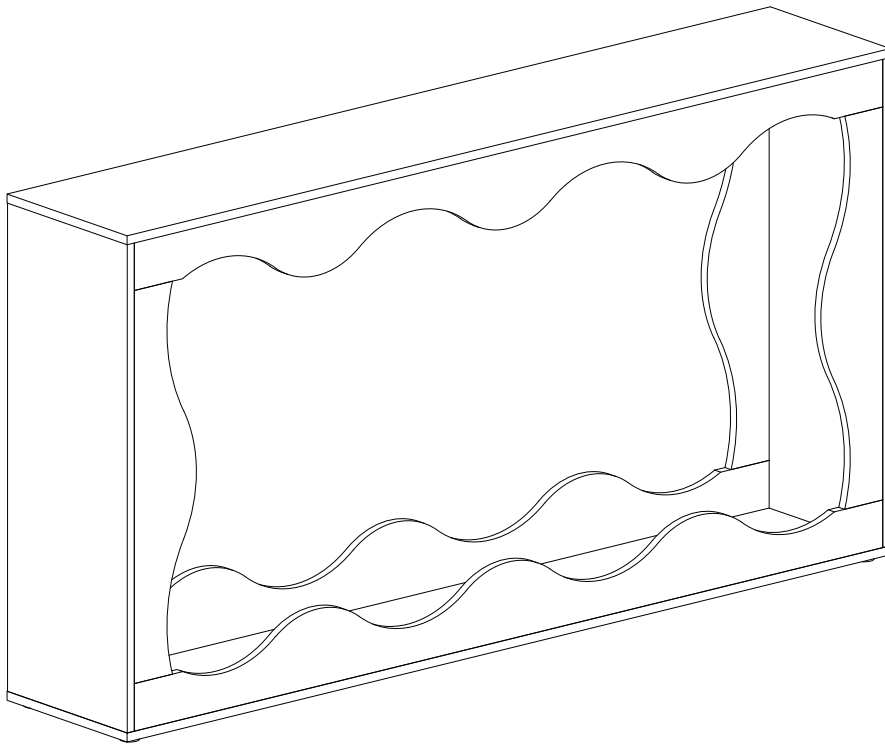

Contact Us

We're here to help you.

Your satisfaction is our top priority. If you encounter any issues with this product, such as missing or damaged parts, we're here to help. Please retain the original packaging and take photos of the packaging and the product, then contact us as soon as possible.

Warm Tips

1. Carefully read these instructions and keep them for future reference.
2. Check the parts list and confirm everything's there before starting assembly.
3. When assembling, put all parts on a soft, smooth surface like a carpet to avoid scratches.
4. Don't fully tighten screws until all parts are confirmed in place to avoid misalignment.

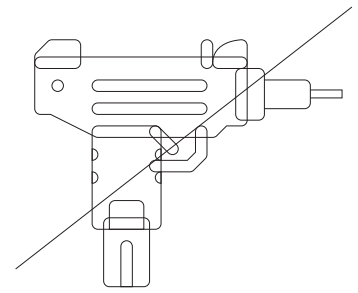
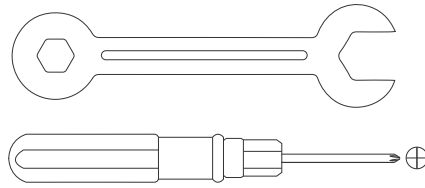
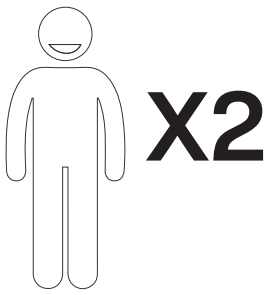

We recommend using hand tools for assembly.

If an electric screwdriver is used, reduce power and torque to avoid damage to the product.

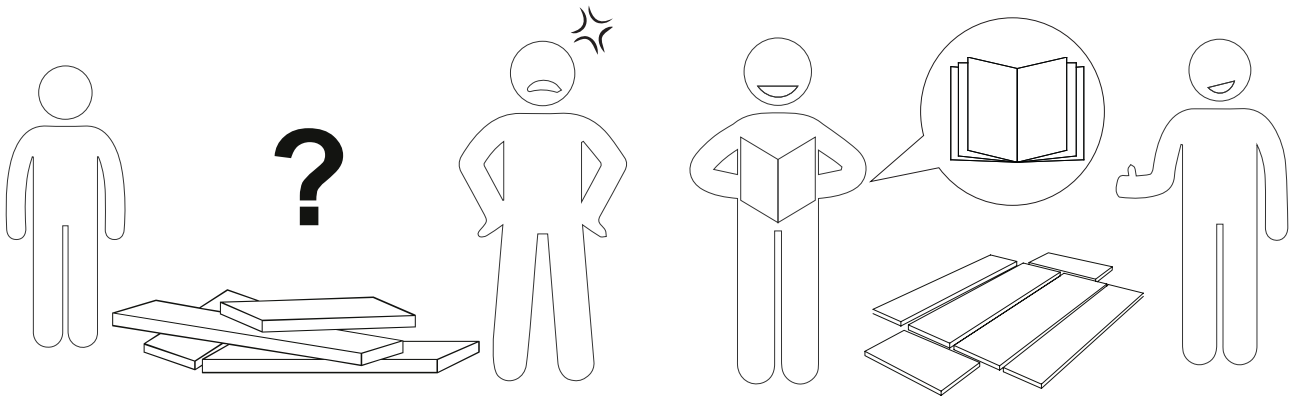

Install the Anti-Tip Straps

Using the anti-tip straps can reduce the risk of tipping over, but can not eliminate it.

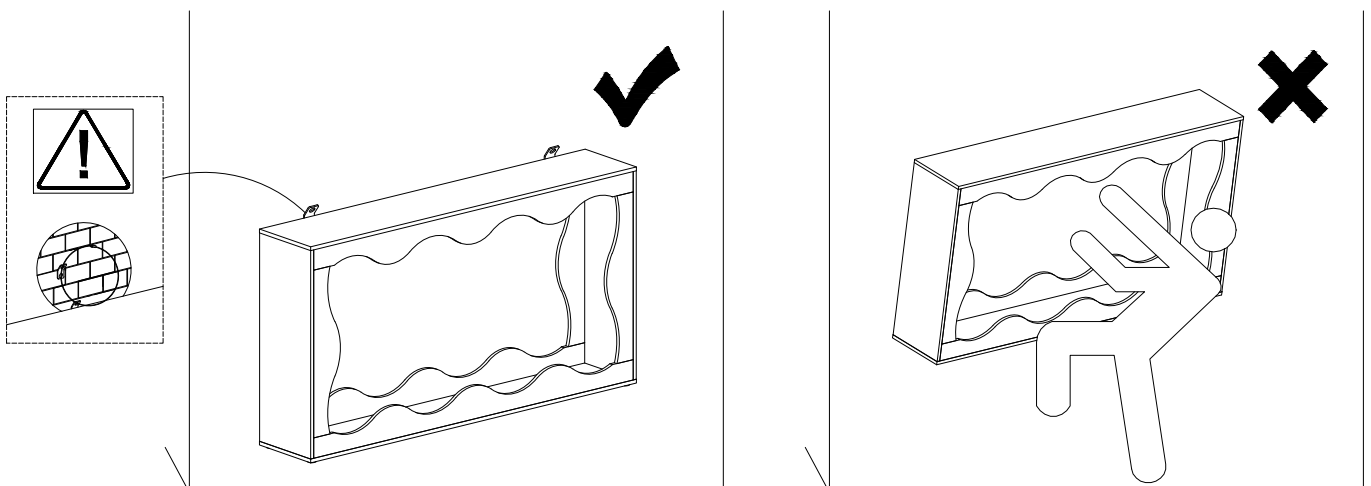

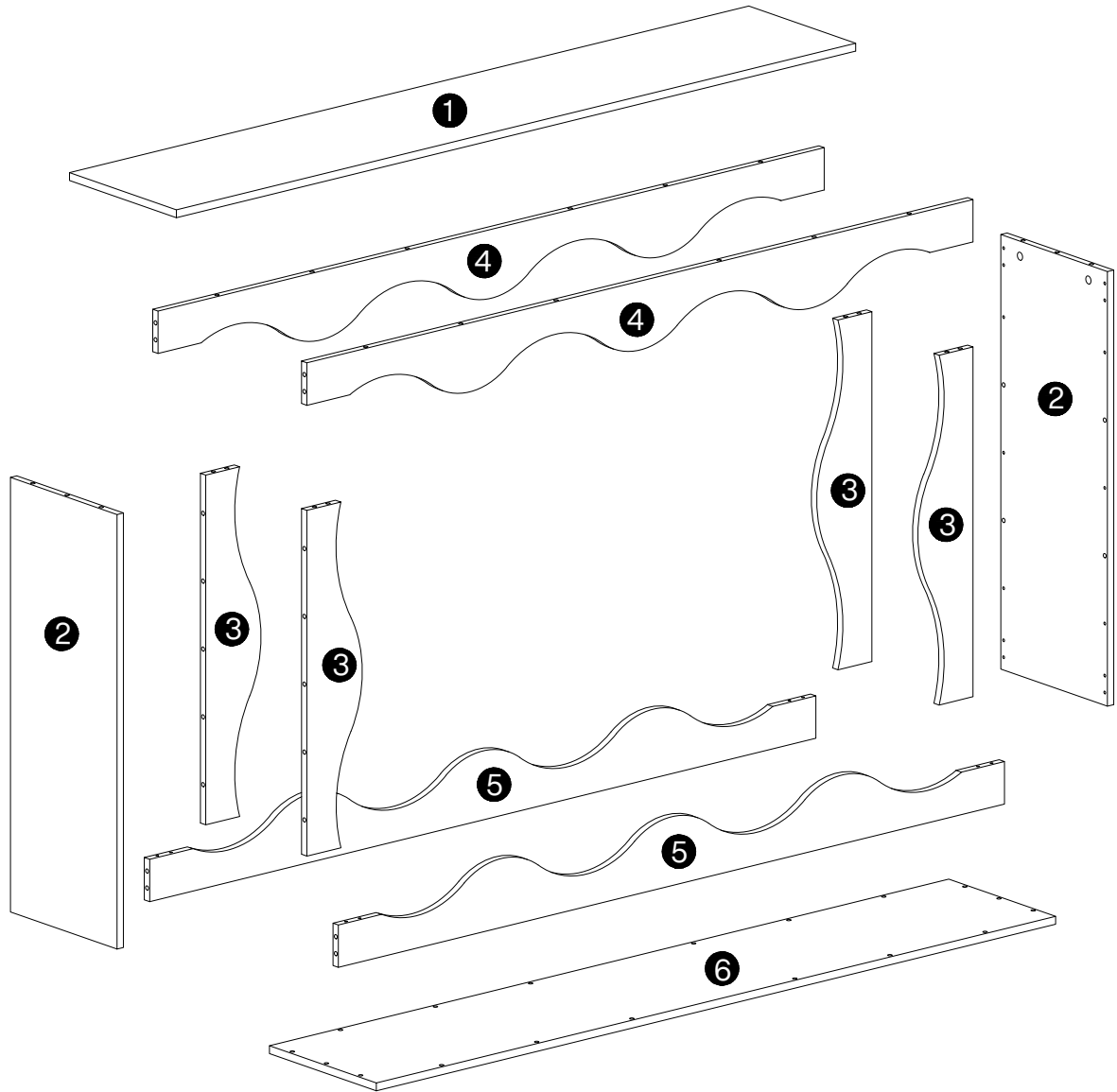

⚠ Caution

Make sure all parts are included. Most board parts are labeled or stamped on the raw edge. Contact us for a free replacement if you encounter any damaged or missing parts.

Parts List

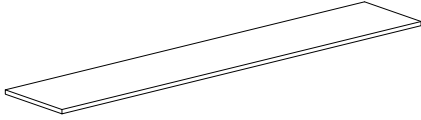

① 1pc

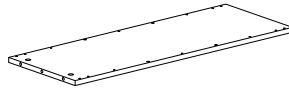

② 2 pcs

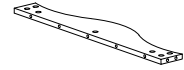

③ 4 pcs

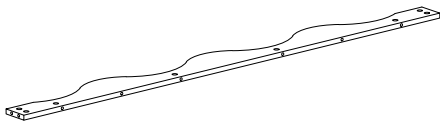

④ 2 pcs

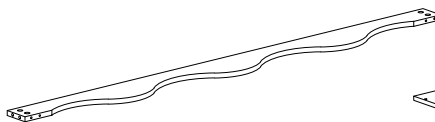



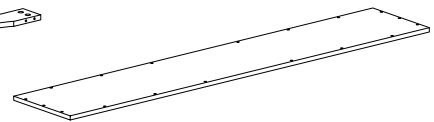





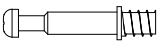

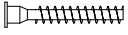
⑤ 2 pcs



⑥ 1pc

Hardware List

A	X56+1	B	X56+1	C	X20+1	D	X12+1	E	X1	F	X2+1
											
Ø6X35 mm	Ø15X12 mm	Ø8X30 mm	Ø7X47 mm	M4X55 mm	3.5X14 mm						

G	X2+1	H	X2	I	X2	J	X6	K	X4
									
4X35 mm	Ø8X40 mm	L250 mm	M6XØ30 mm	26X13 mm					

1

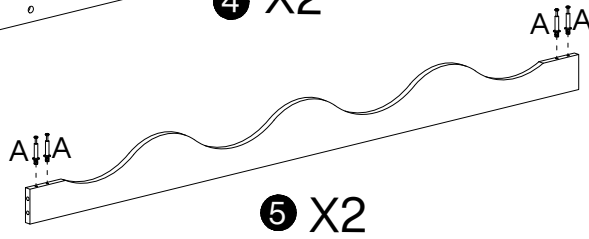
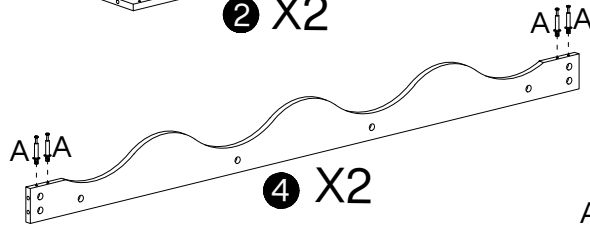
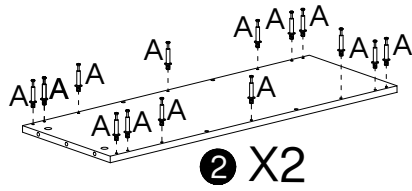
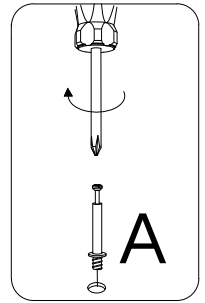
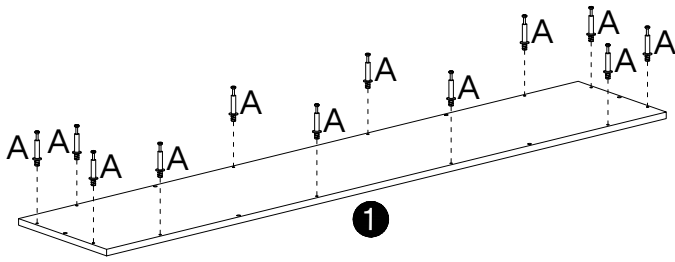

A	X56
Ø6X35 mm	

2

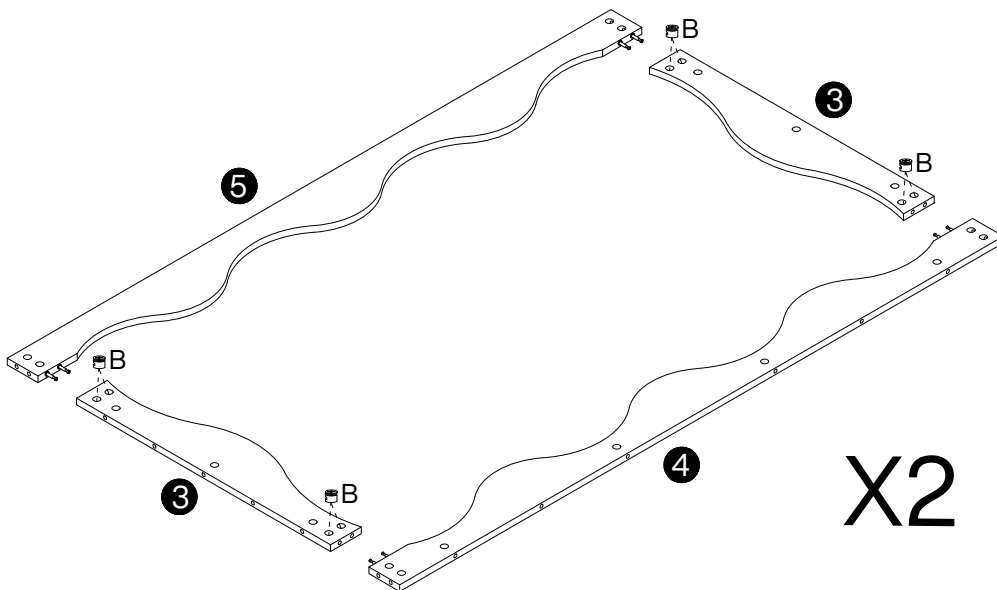

B	X16
Ø15X12 mm	

3

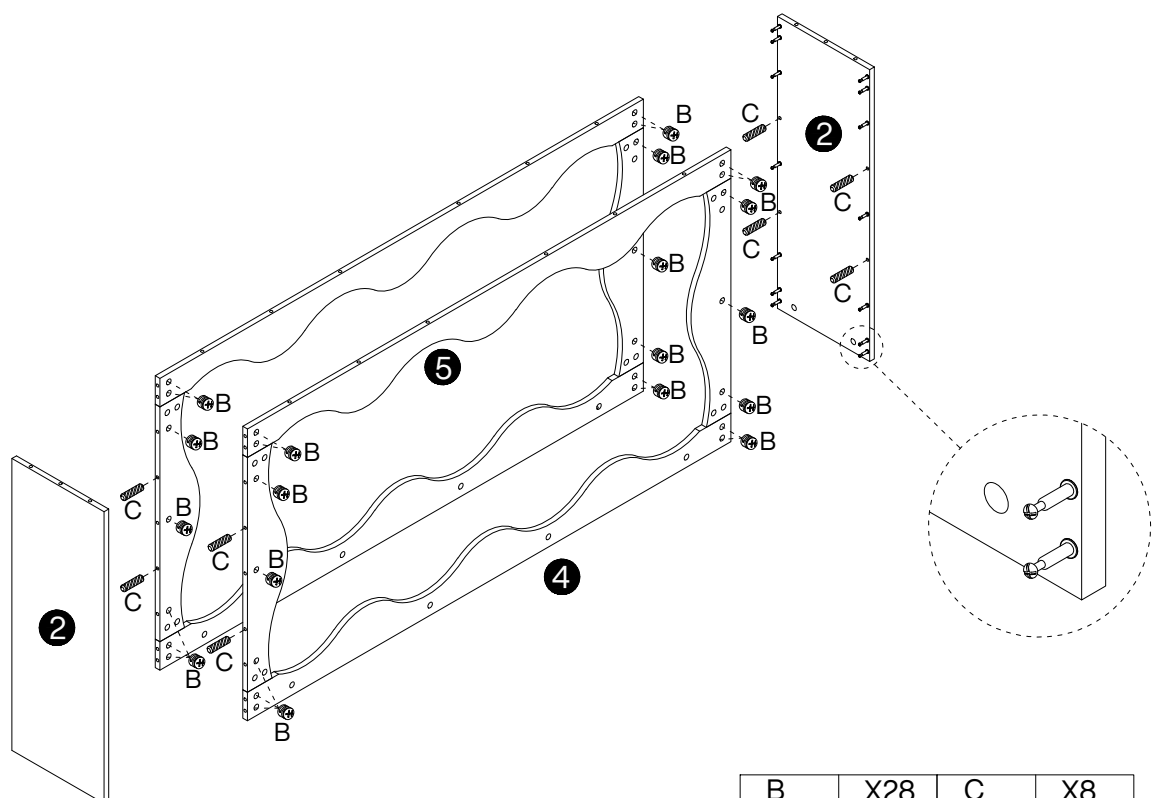

B	X28	C	X8
Ø15X12 mm		Ø8X30 mm	

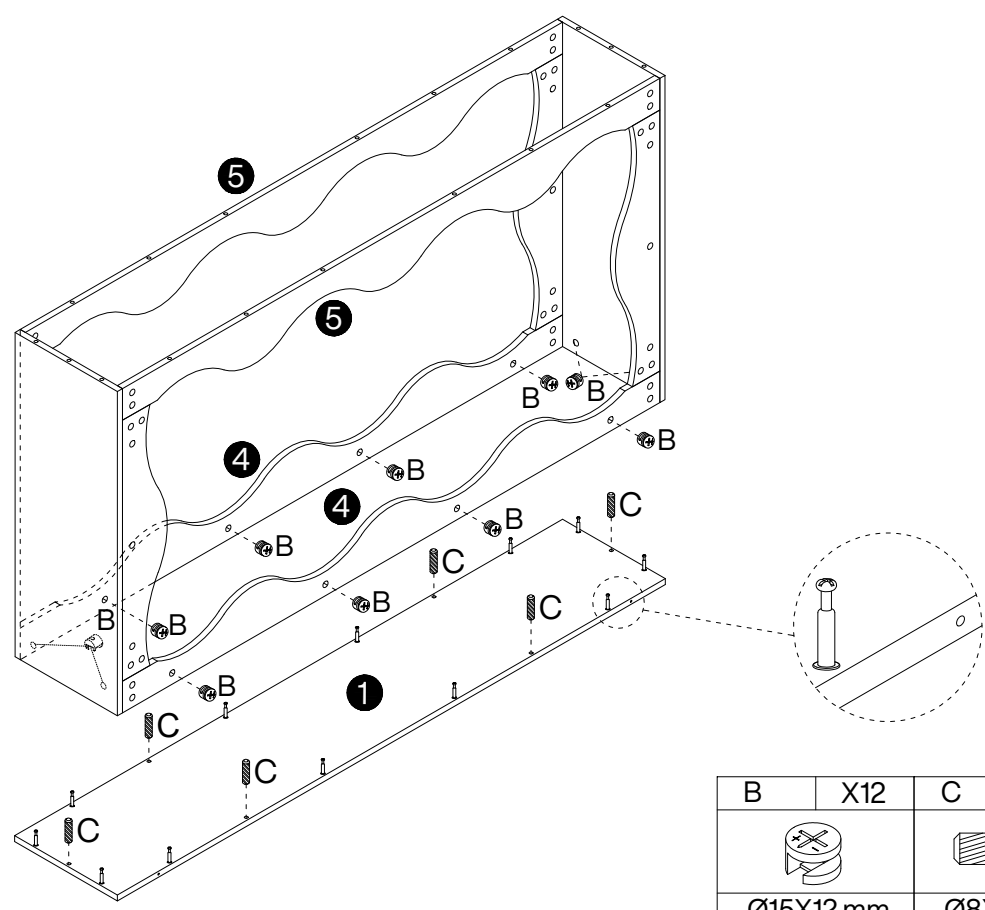

4

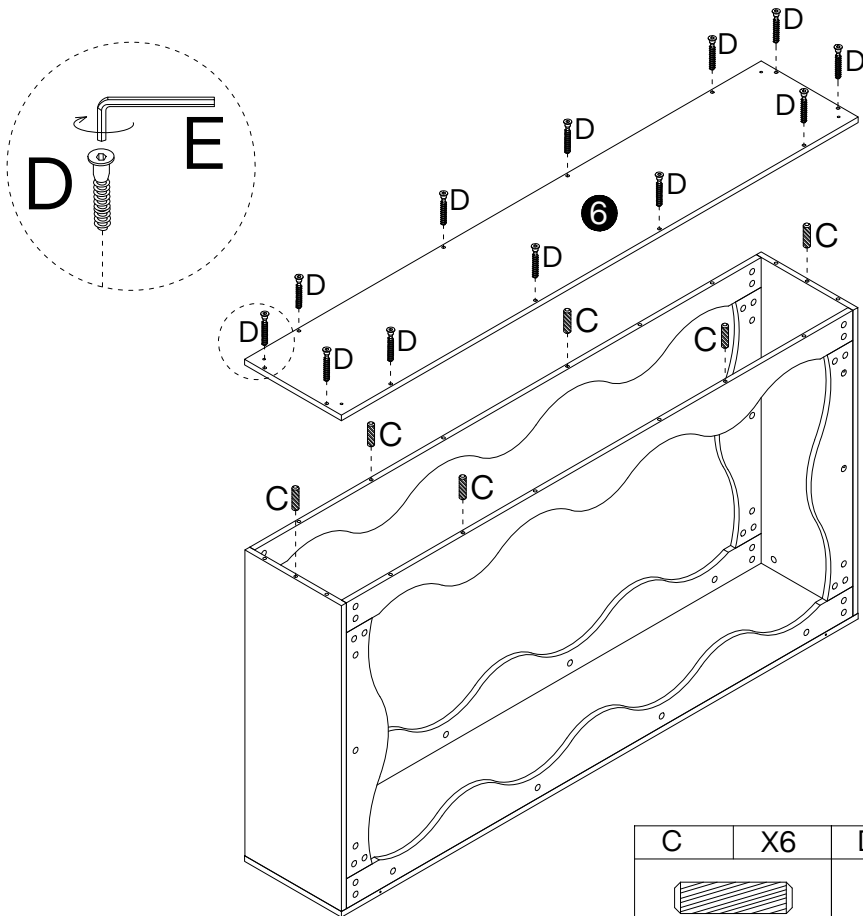

B	X12	C	X6
Ø15X12 mm		Ø8X30 mm	

5

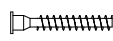

C	X6	D	X12	E	X1
					
Ø8X30 mm		Ø7X47 mm		M4X55 mm	

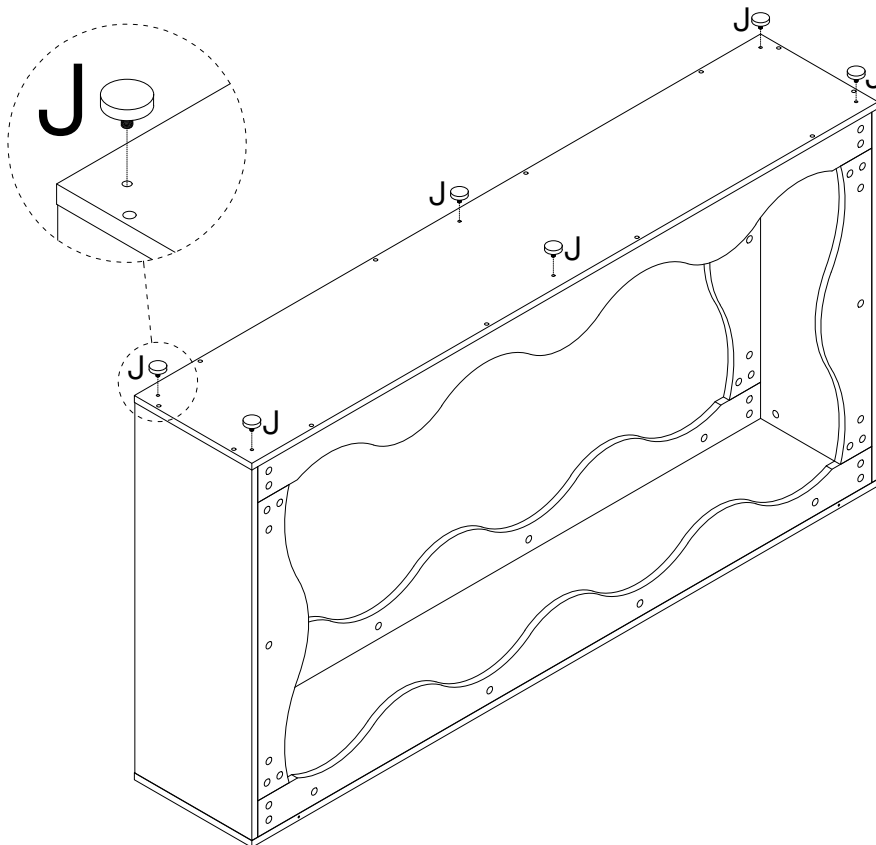

6



J	X6
	
M6XØ30 mm	

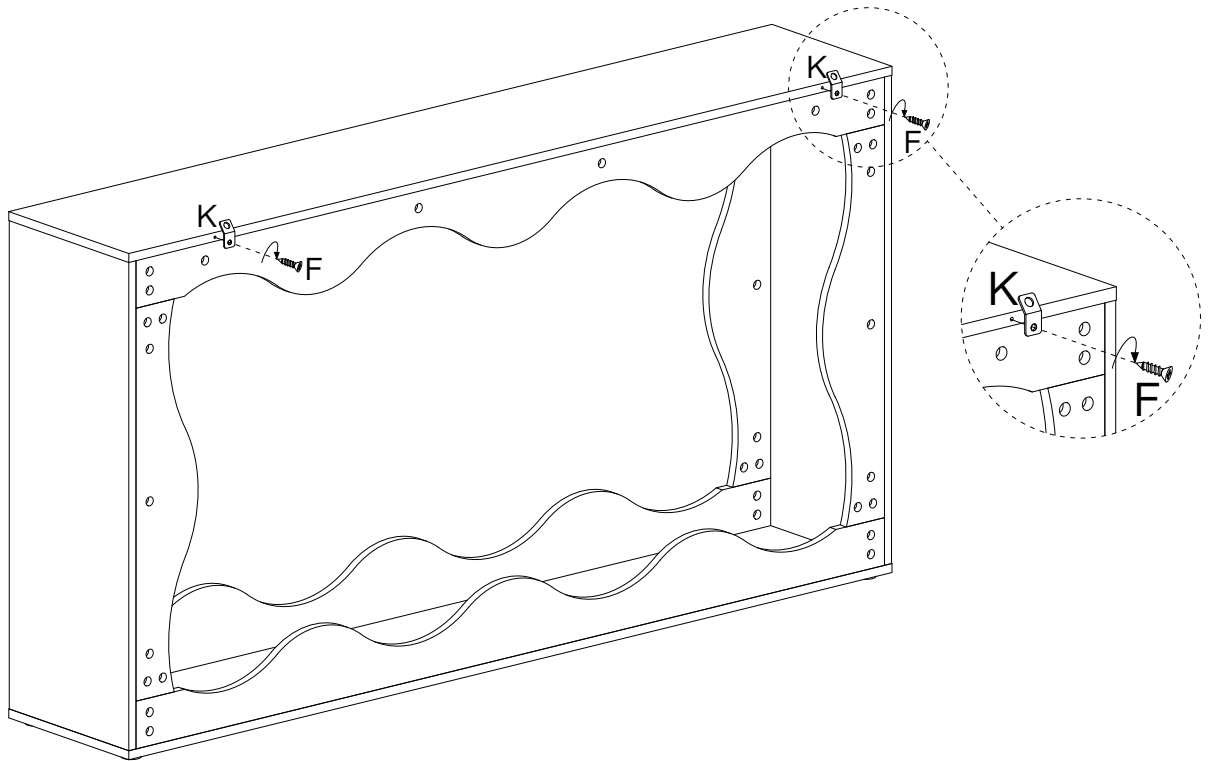

7

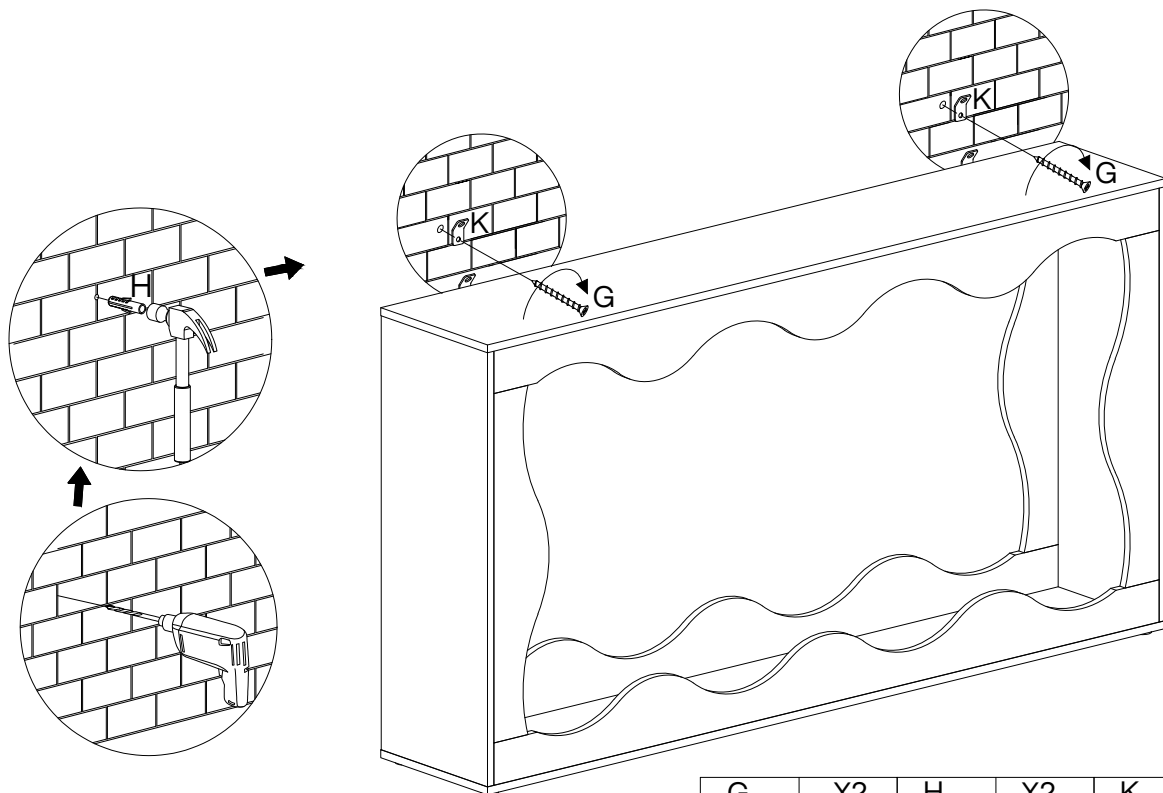

F	X2	K	X2
			
3.5X14 mm		26X13 mm	

8



G	X2	H	X2	K	X2
					
4X35 mm		Ø8X40 mm		26X13 mm	

9

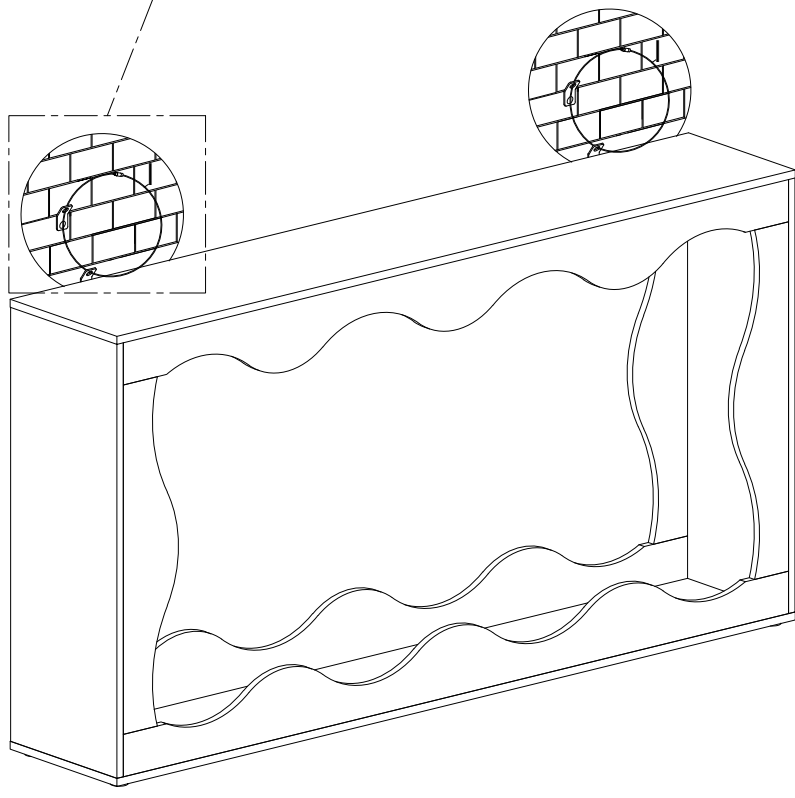
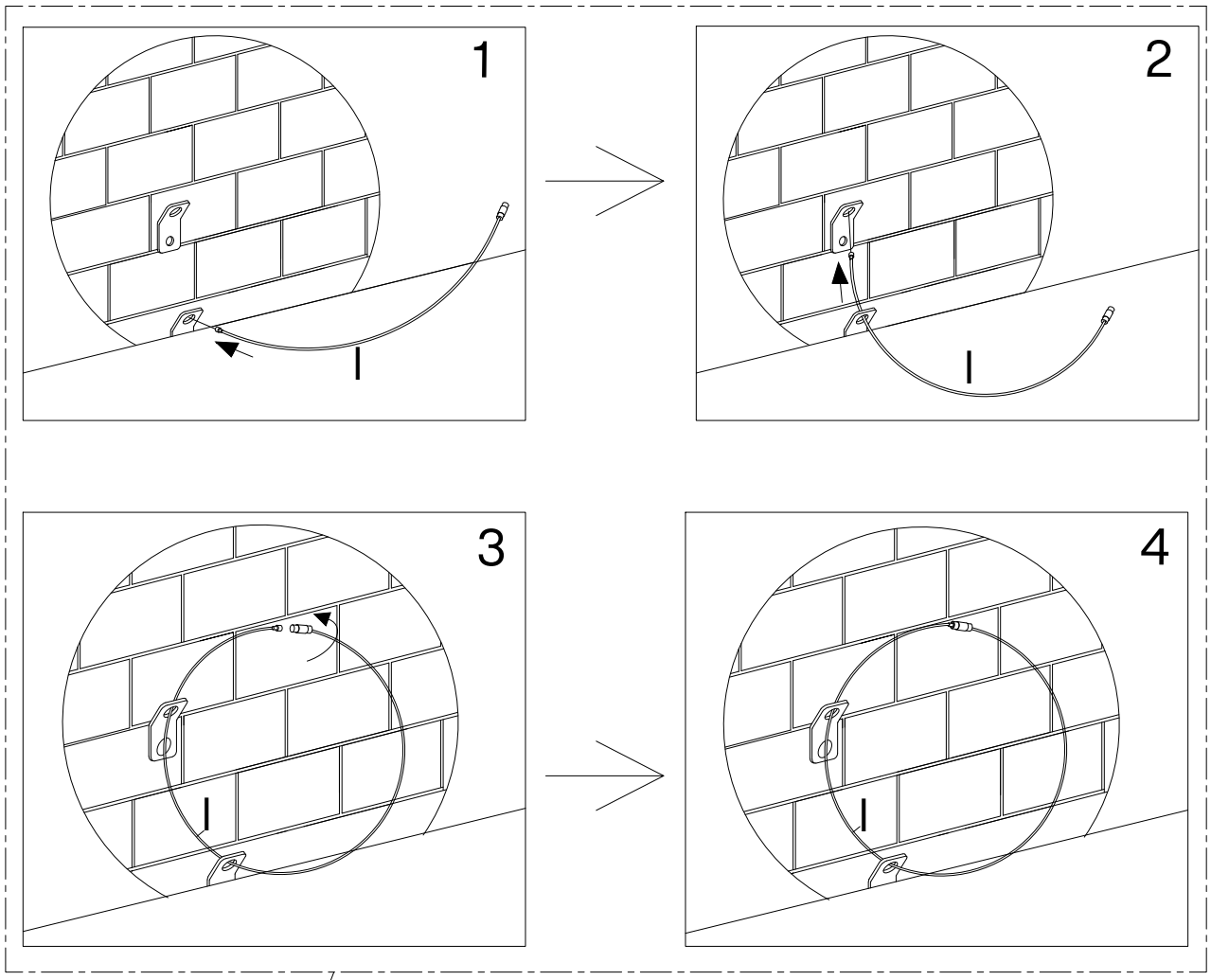

1	X2
L250 mm	

Thank you for your support!

