

# ASSEMBLY INSTRUCTIONS

## BED - FULL

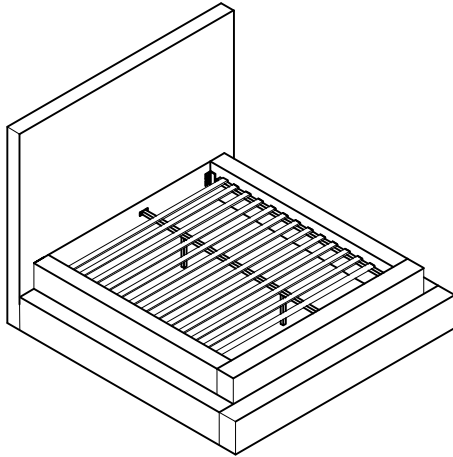

### + Parts Included

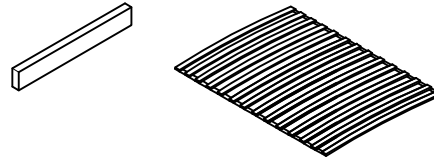
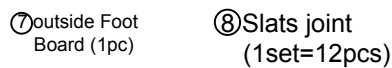
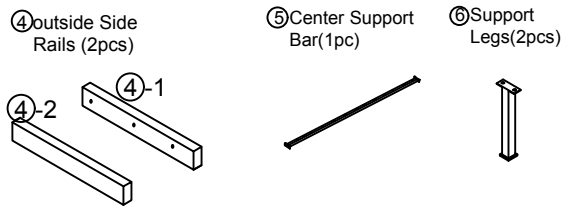
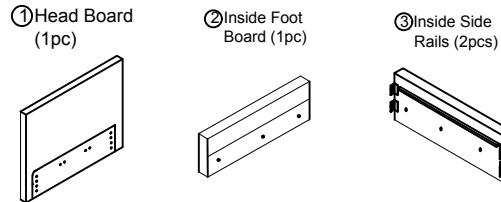

\*Slats come packed in the bottom of headboard carton.

### + Do Not Use Power Tools

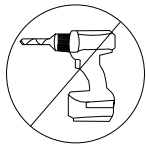

### + Suggested Adults

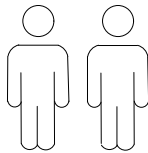

#### NOTE :

- 1 Read instructions cover to cover.
- 2 Save all packaging until assembly is completed.

### 1 IMPORTANT SAFETY INFORMATION

Do not assemble the product if any of the following parts arrived damaged:

- Part # ③/④ - Side Rails
- Part # ⑤ - Center Support Bar
- Part # ⑥ - Support Legs
- Part # ⑧ - Slats joint

### 2 IMPORTANT ASSEMBLY INFORMATION

Assembly Step ③ Ensure the side rail bracket is fully hooked onto bolt **C** loosely threaded with both washers on the **OUTSIDE** of the bracket first, then proceed to fully tightening all 4 corners.

### + Hardware Included

- A Bolt M8\*30mm (8pcs)    B Bolt M8\*200mm (9pcs)    C Bolt M8\*40mm (16pcs)



- D Spring Washer (16pcs)    E Flat Washer  $\phi$ 20 (24pcs)    F M8 Allen Key (1pc)



- G Flat Washer  $\phi$ 22 (9pcs)



- I Nut M8\*13mm (13pcs)



- J Spanner (1pc)



# ASSEMBLY INSTRUCTIONS

## BED - FULL

