

Sofa Bed

ASSEMBLY INSTRUCTIONS

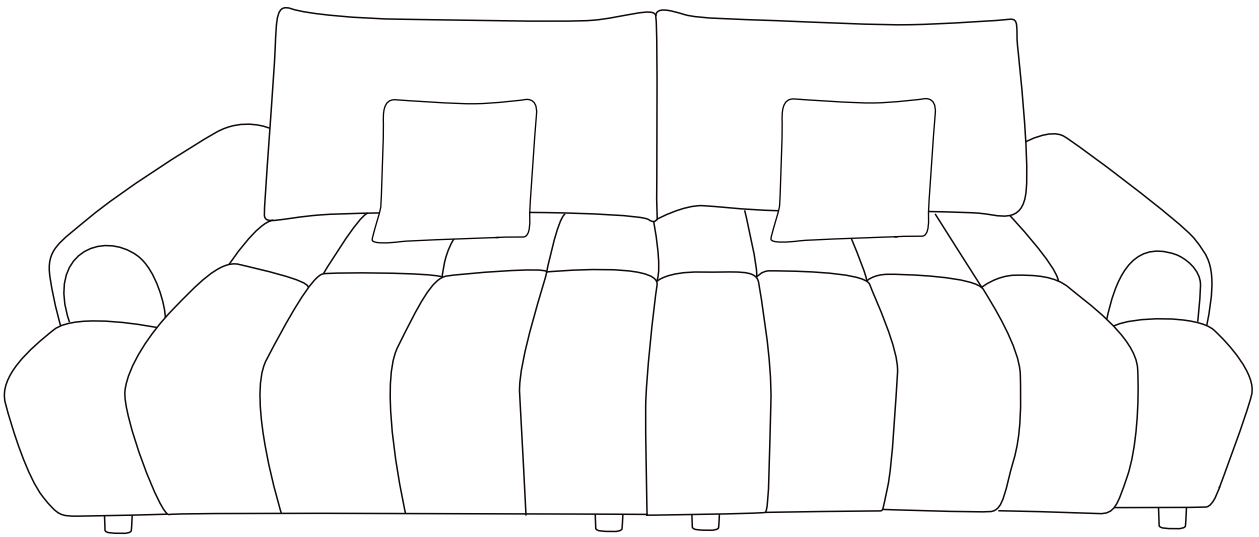





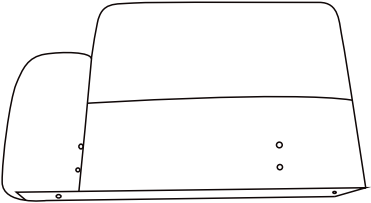
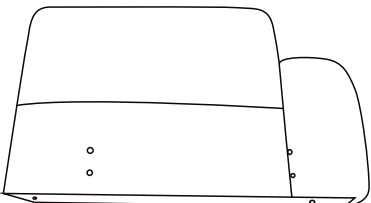

Two person assemble the sofa will be more easier.

Parts List

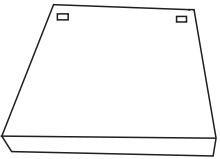
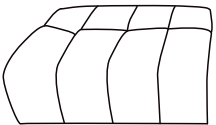
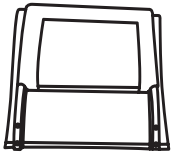
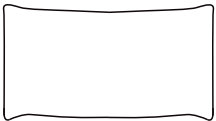
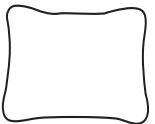
BOX A

<p>A</p> 	<p>B</p> 	
<p>1PC</p>	<p>1PC</p>	

BOX B

<p>C</p> 	<p>D</p> 	<p>E</p> 	<p>F</p> 
<p>2PCS</p>	<p>2PCS</p>	<p>2PCS</p>	<p>2PCS</p>
<p>G</p> 	<p>F</p> 	<p>①</p> 	<p>②</p>  <p>M8x50mm</p>
<p>2PCS</p>	<p>8PCS</p>	<p>8PCS</p>	<p>18PCS</p>
<p>③</p> 	<p>④</p> 	<p>⑤</p> 	
<p>2PCS</p>	<p>18PCS</p>	<p>1PC</p>	

Assembly Instruction

The cushions is packaged by vacuum compression. After cutting the package, it rebounds quickly within 4 hours. If the fabric has wrinkles, it will basically disappear after standing for 72 hours

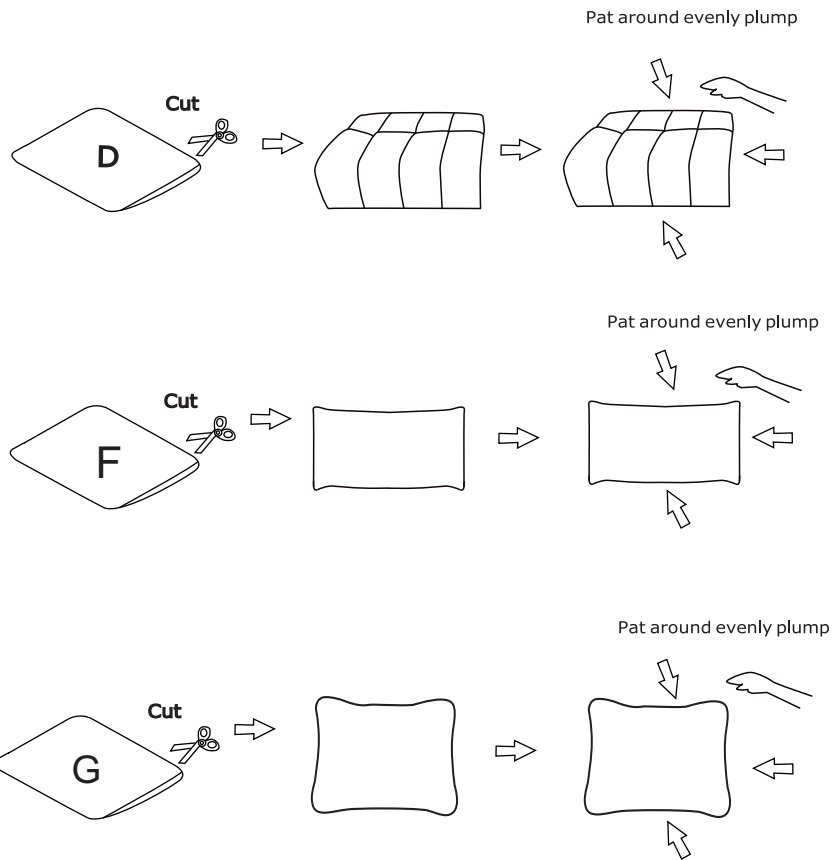

Assembly Instruction

Step 1

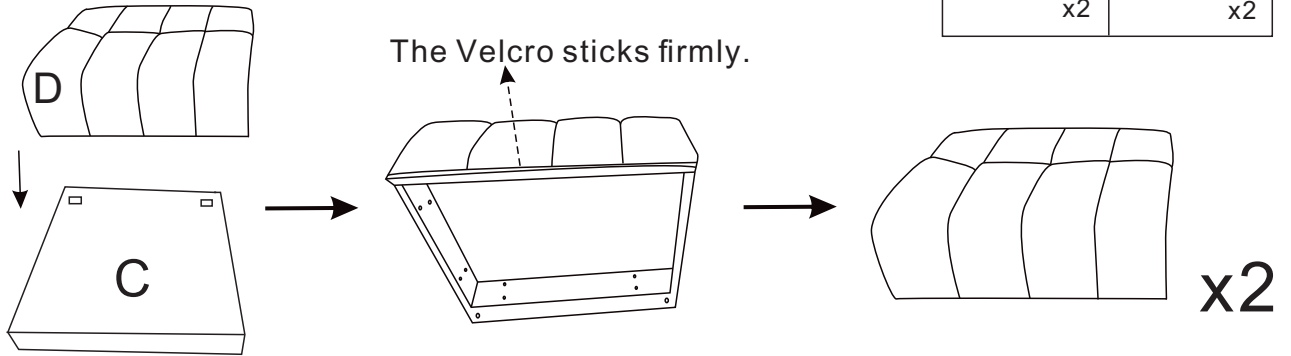

Step 2

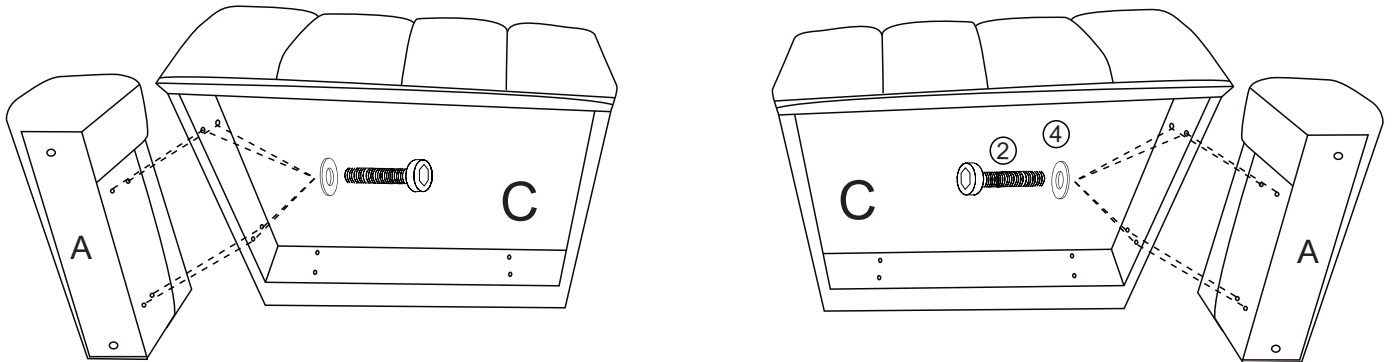
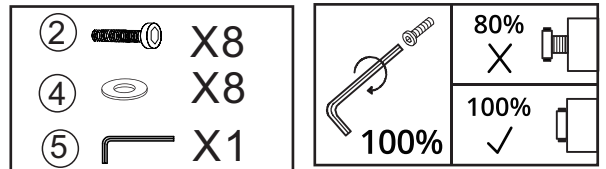



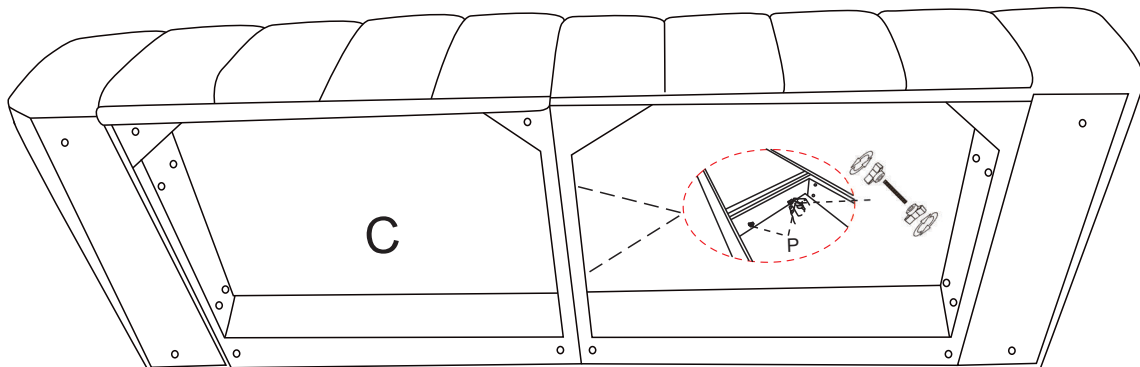
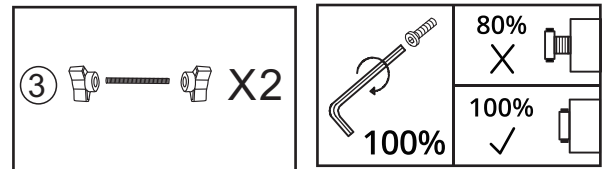

Step 3



Assembly Instruction



Step 4

②		X12
④		X12
⑤		X1

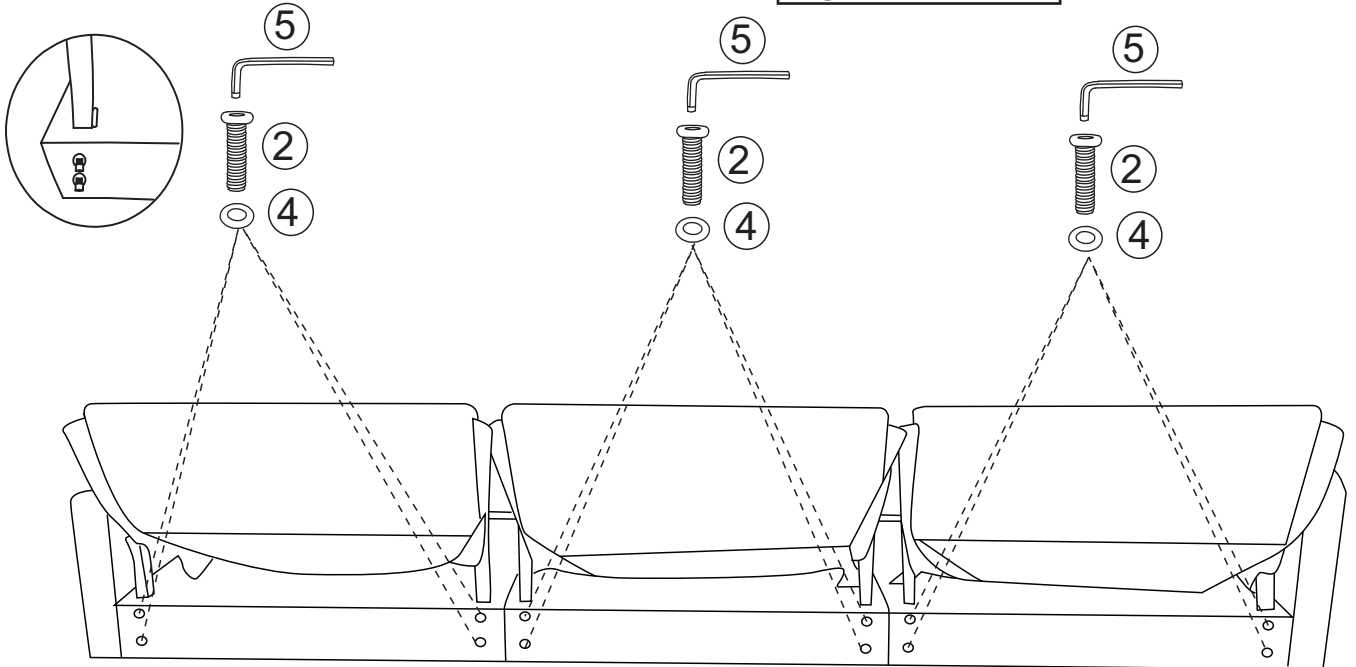
	80% X
	100% ✓



Step 5

F		X8
①		X8

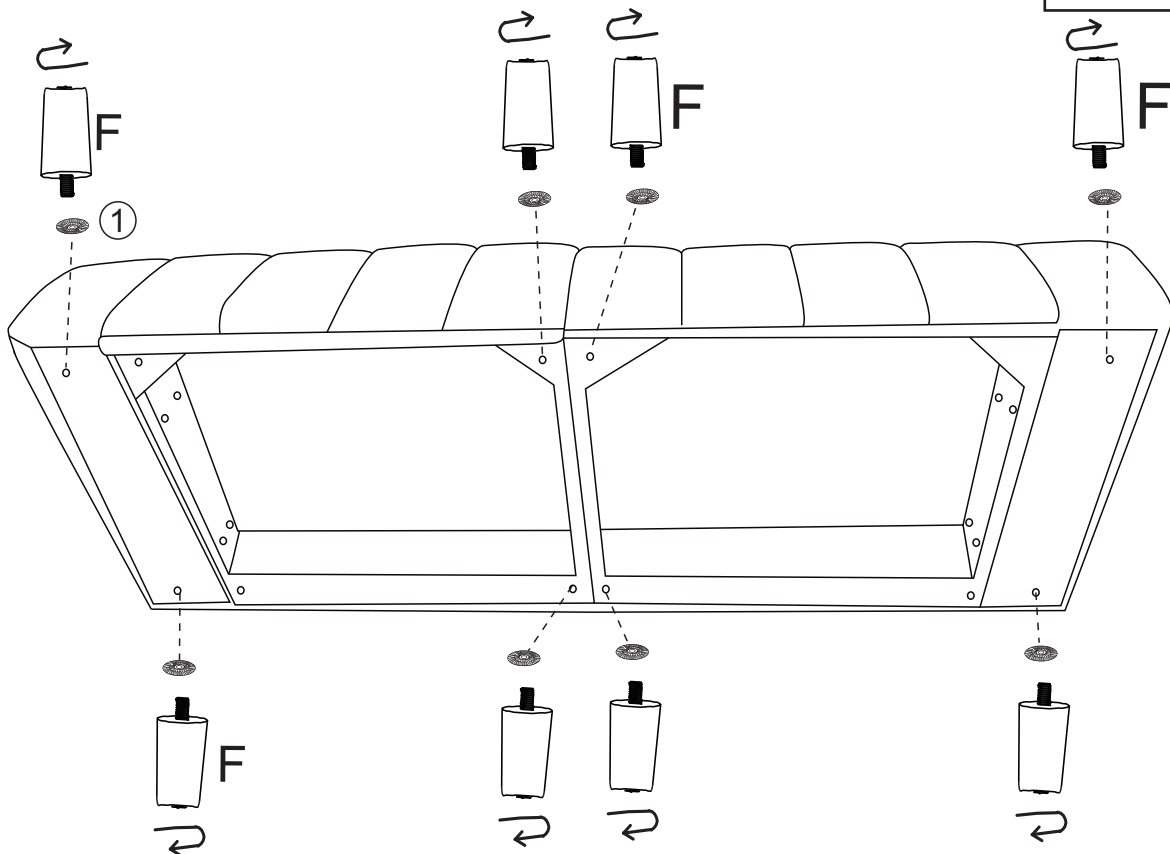

Assembly Instruction

Step6

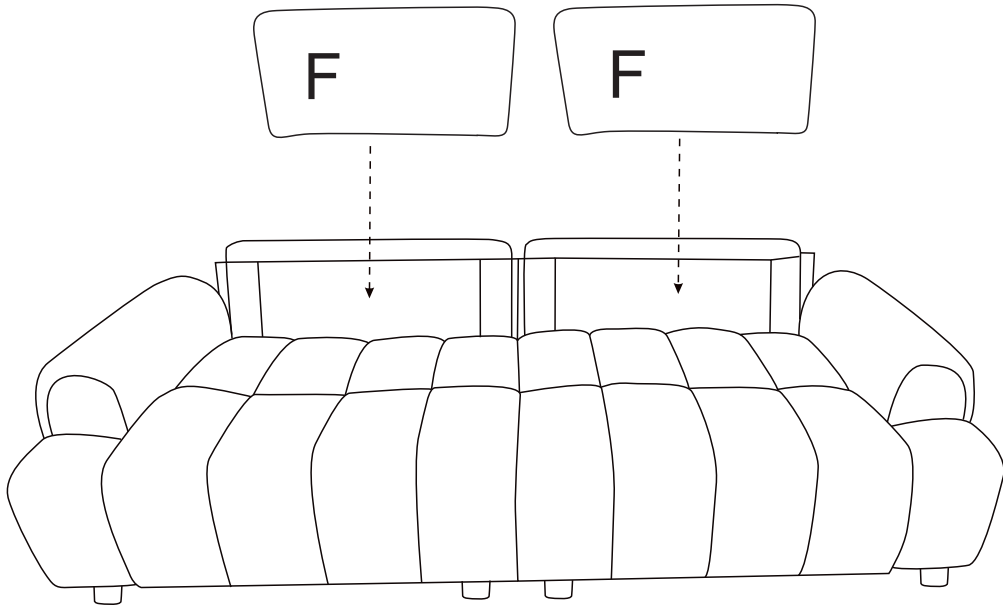
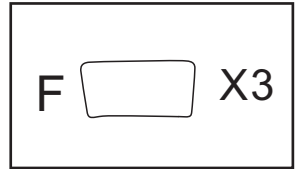

Step7

