

Hall tree

The assembly instructions

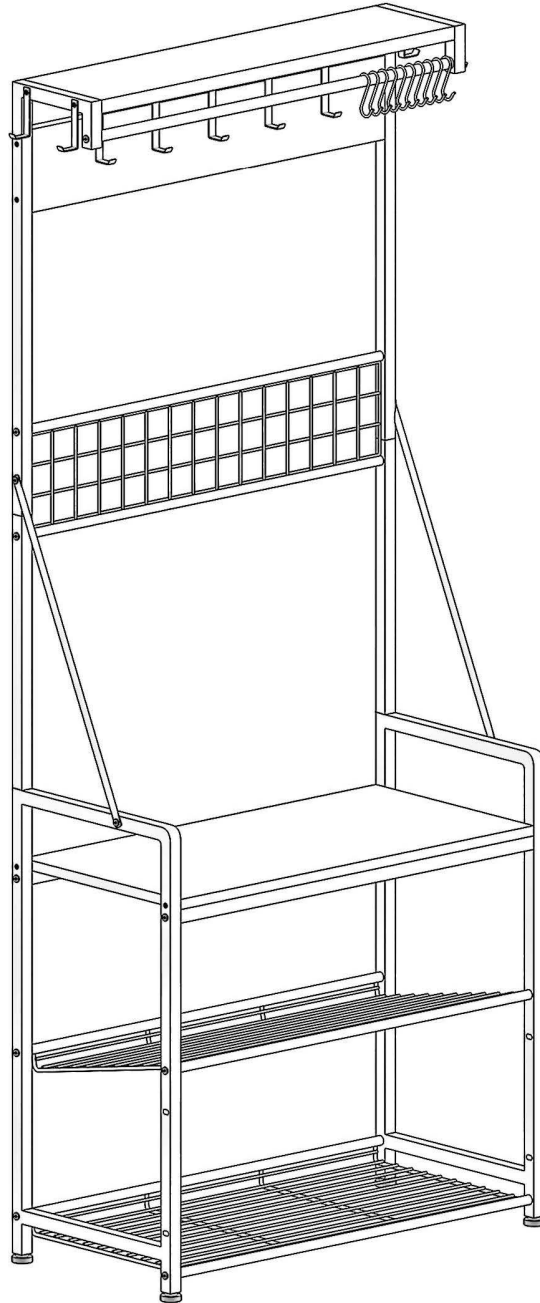

Thank you for purchasing our products, please read the instructions carefully before you assemble the product, please do not hesitate to contact us if there is assembly problem, there will be someone to guide assembly.

MATTERS NEEDING ATTENTION

Please follow the instruction manuals and use a pad to avoid damage during assembly.

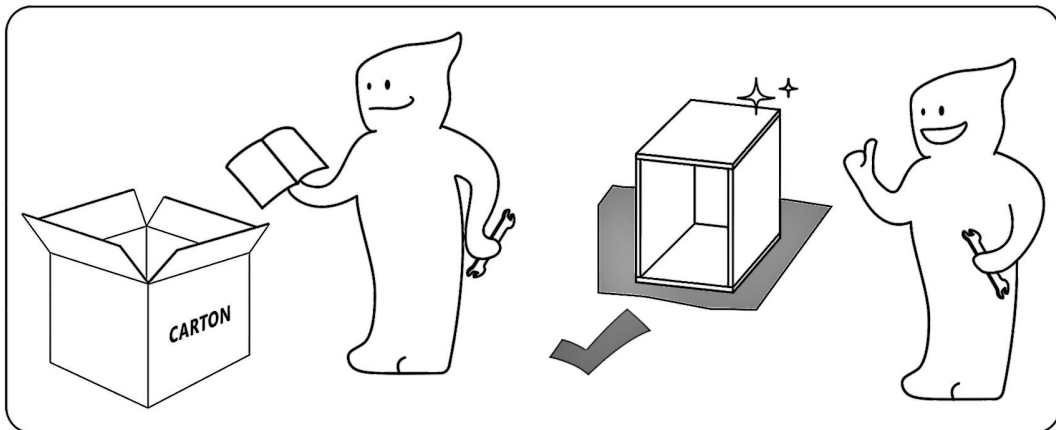
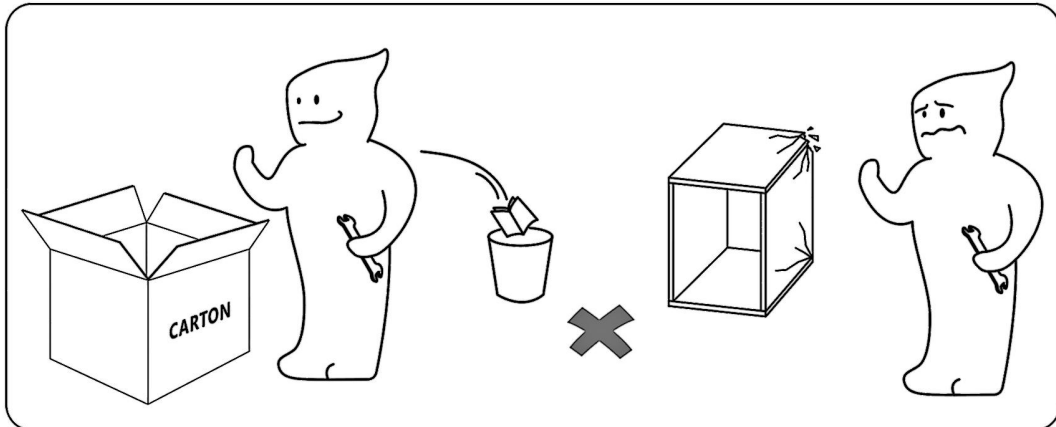

1  Not intended for use by children.







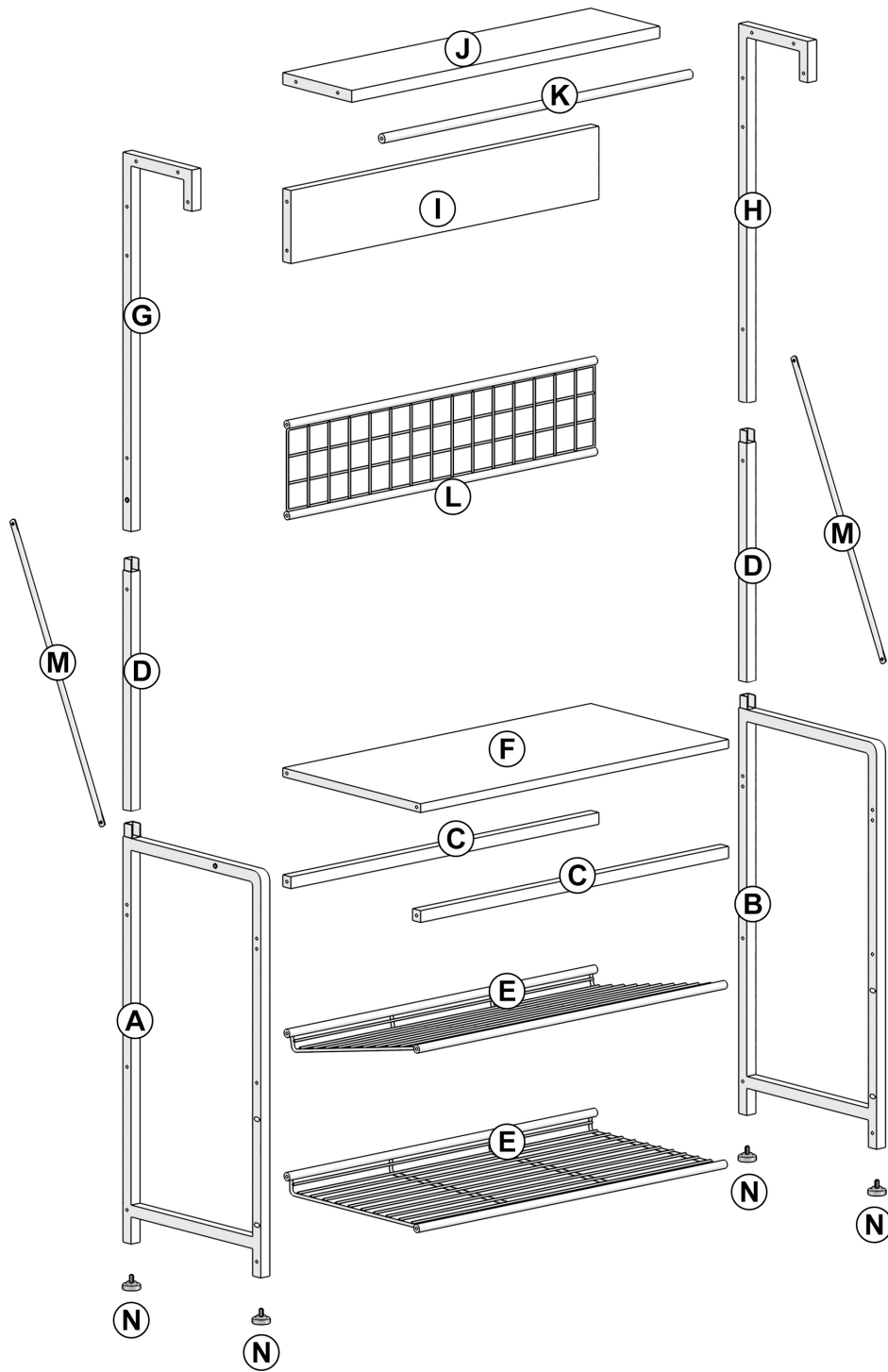

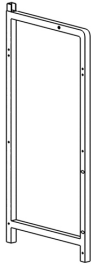
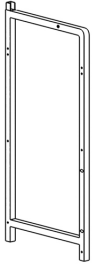
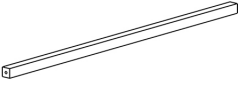

2  Keep away from fire or other heat sources.

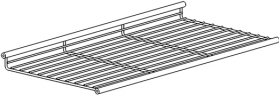
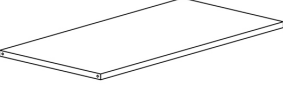
3  We recommend wearing protective gloves.

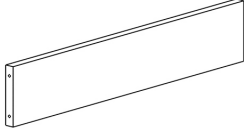
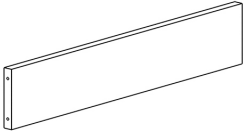
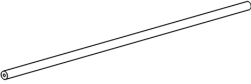
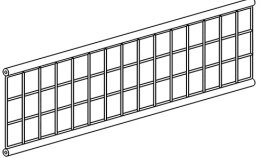
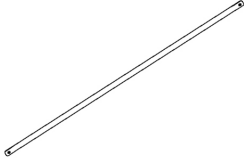
● Product accessories

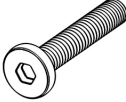
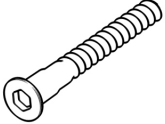

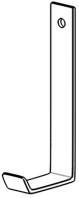
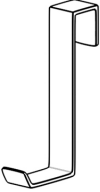

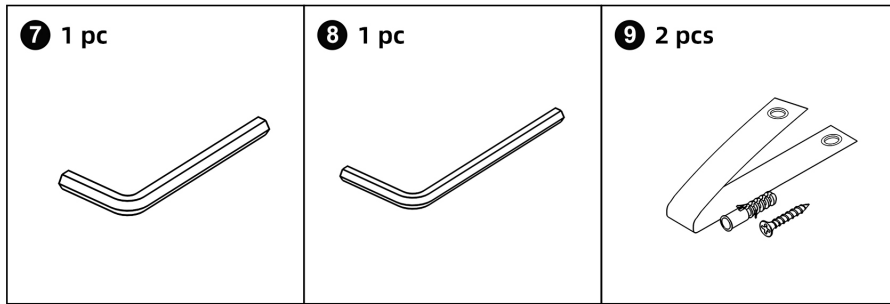

● Accessories List

<p>A 1 pc</p> 	<p>B 1 pc</p> 	<p>C 2 pcs</p> 	<p>D 2 pcs</p> 
<p>E 2 pcs</p> 	<p>F 1 pc</p> 	<p>G 1 pc</p> 	<p>H 1 pc</p> 
<p>I 1 pc</p> 	<p>J 1 pc</p> 	<p>K 1 pc</p> 	<p>L 1 pc</p> 
<p>M 2 pcs</p> 	<p>N 4 pcs</p> 	<p>1 18 pcs</p> 	<p>2 12 pcs</p> 
<p>3 8 pcs</p> 	<p>4 4 pcs</p> 	<p>5 5 pcs</p> 	<p>6 10 pcs</p> 

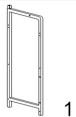
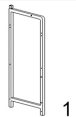

● Assemble steps



● Step 1

<p>(A)</p>  <p>1 pc</p>	<p>(B)</p>  <p>1 pc</p>	<p>(C)</p>  <p>2 pcs</p>	<p>1</p>  <p>4 pcs</p>	<p>7</p>  <p>1 pc</p>
--	--	--	--	---

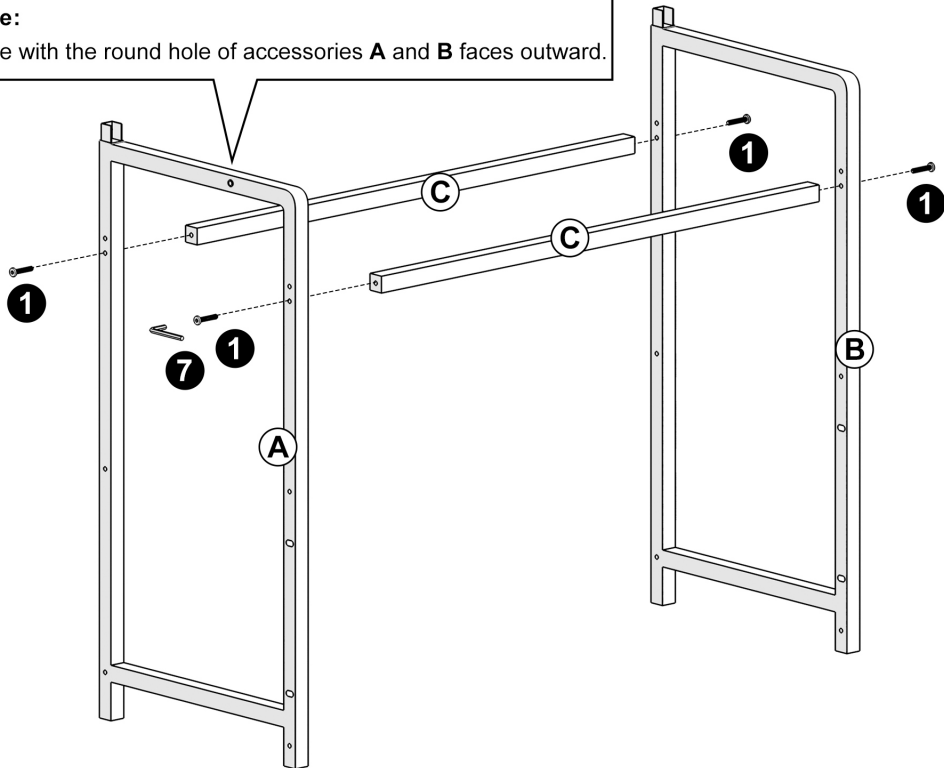
▲ Note:
The side with the round hole of accessories **A** and **B** faces outward.



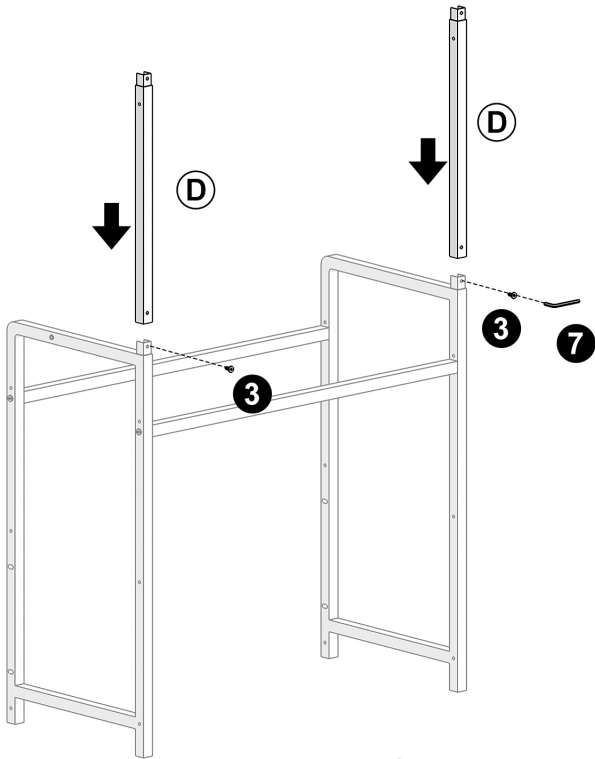

● Step 2

D	3	7
		
2 pcs	2 pcs	1 pc



● Step 3

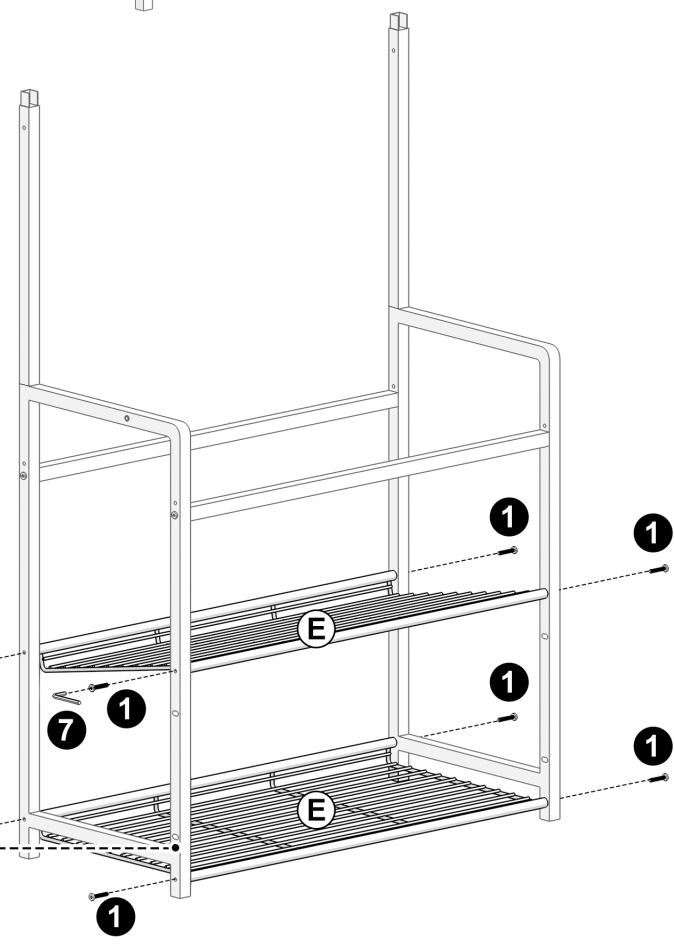

E	1	7
		
2 pcs	8 pcs	1 pc

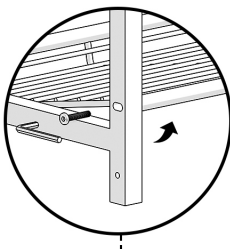

▲ Note:
Accessory E can be placed horizontally or tilted for assembly.



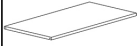

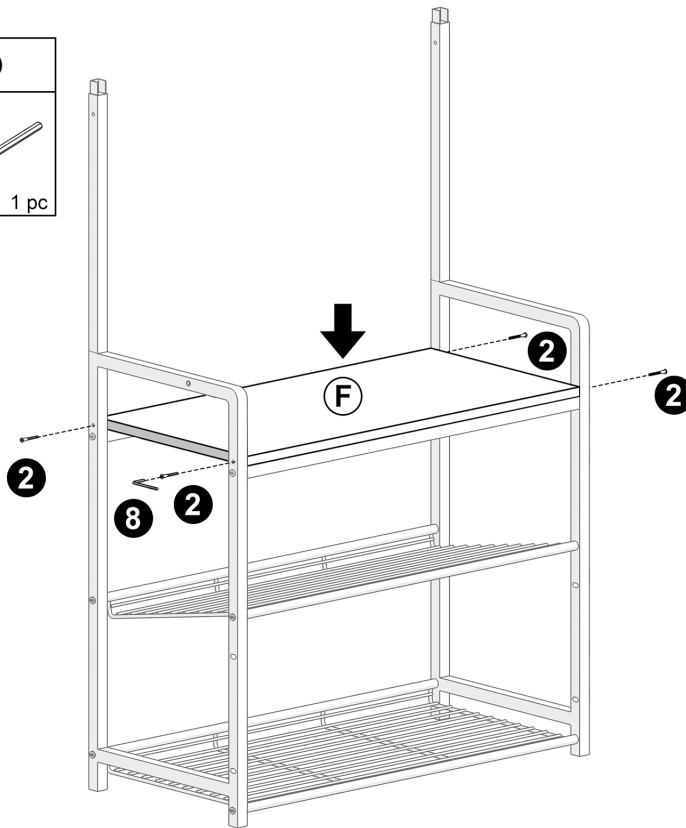

● Step 4

Ⓕ	Ⓒ	Ⓖ
		
1 pc	4 pcs	1 pc





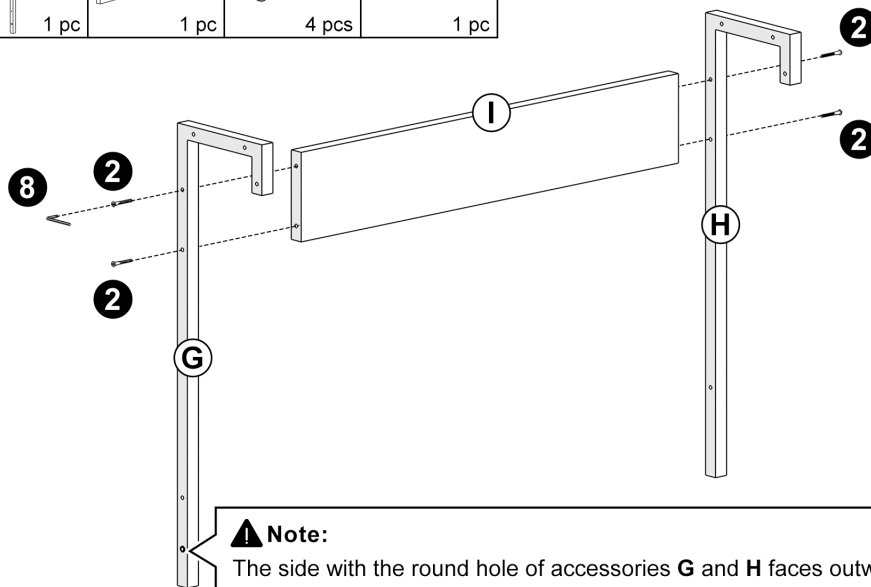

● Step 5

Ⓖ	Ⓗ	Ⓘ	Ⓒ	Ⓖ
				
1 pc	1 pc	1 pc	4 pcs	1 pc





⚠ Note:
The side with the round hole of accessories **G** and **H** faces outward.

● Step 6

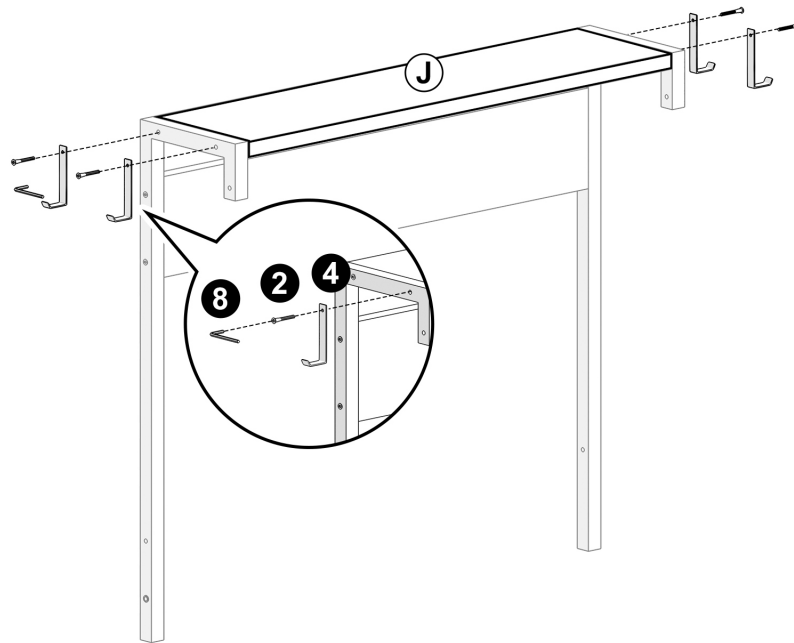
(J)	(4)
 1 pc	 4 pcs
(2)	(8)
 4 pcs	 1 pc



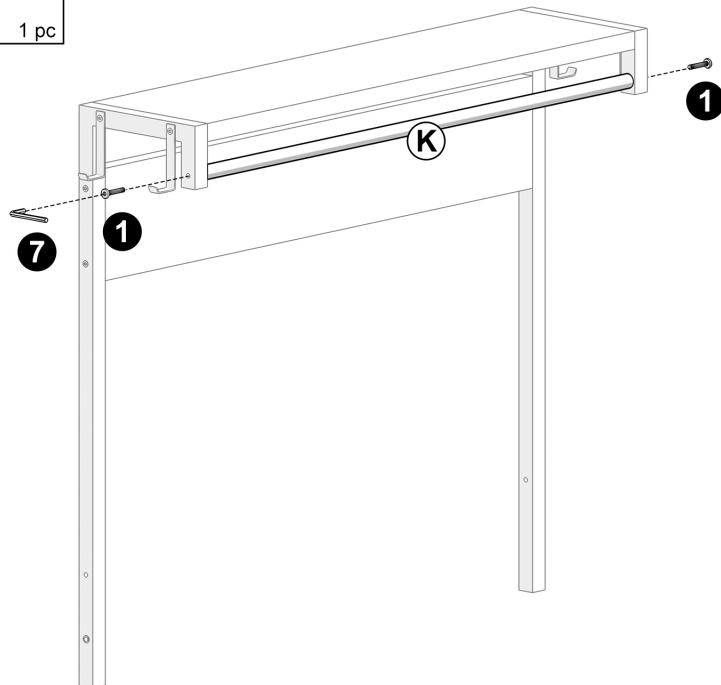

● Step 7

(K)	(1)	(7)
 1 pc	 2 pcs	 1 pc



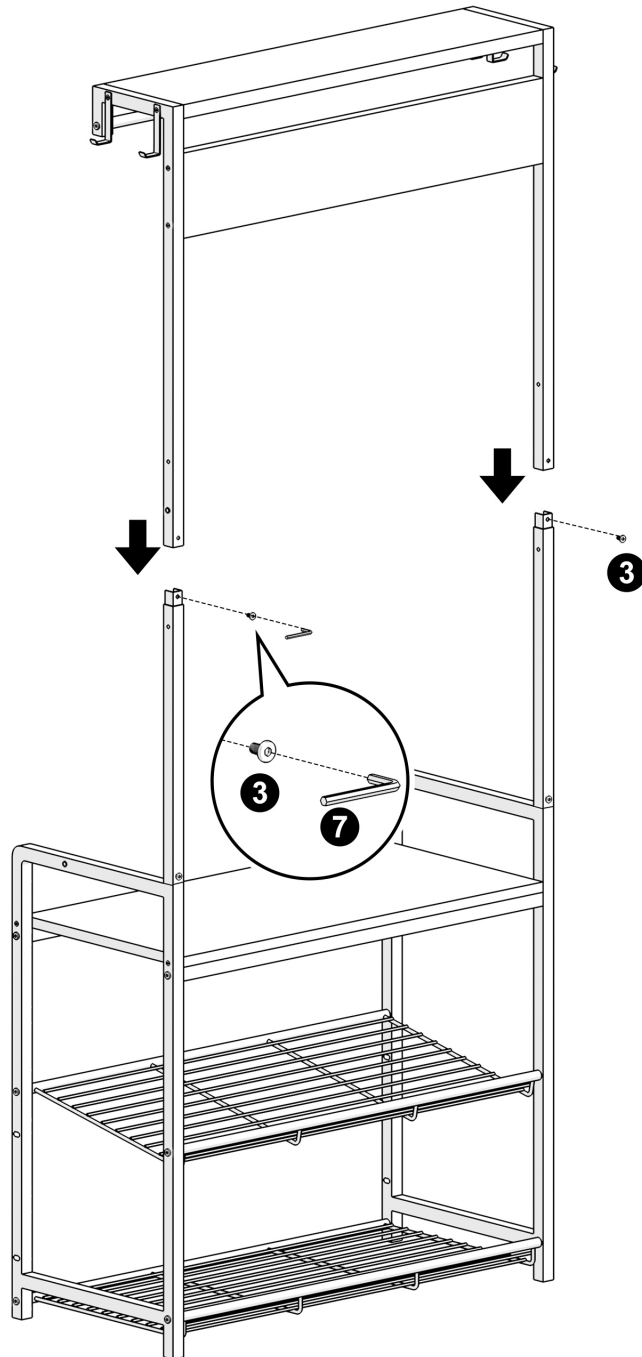

● Step 8

3	7
	
2 pcs	1 pc



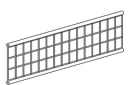

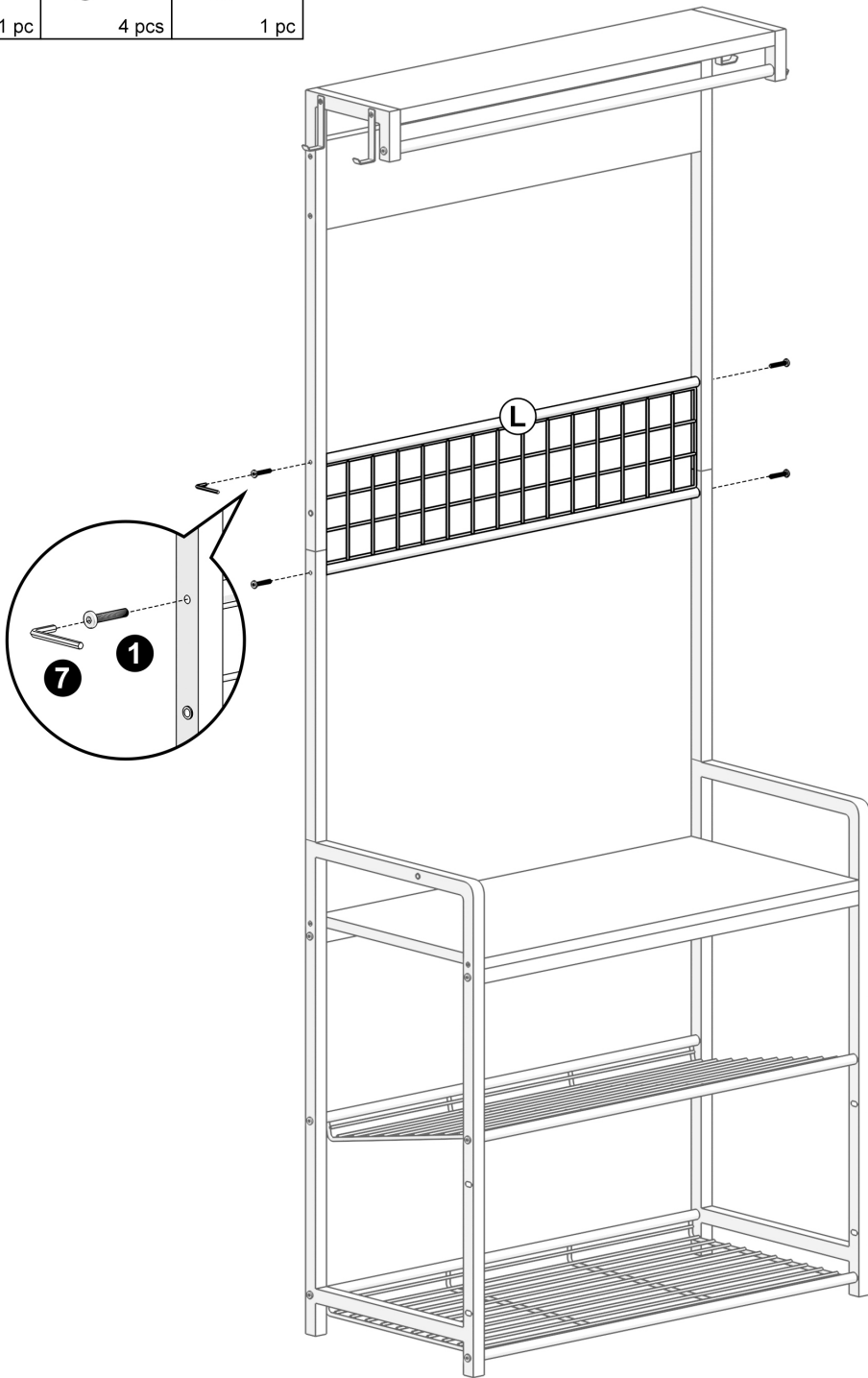

● Step 9

 1 pc	 4 pcs	 1 pc
---	--	---



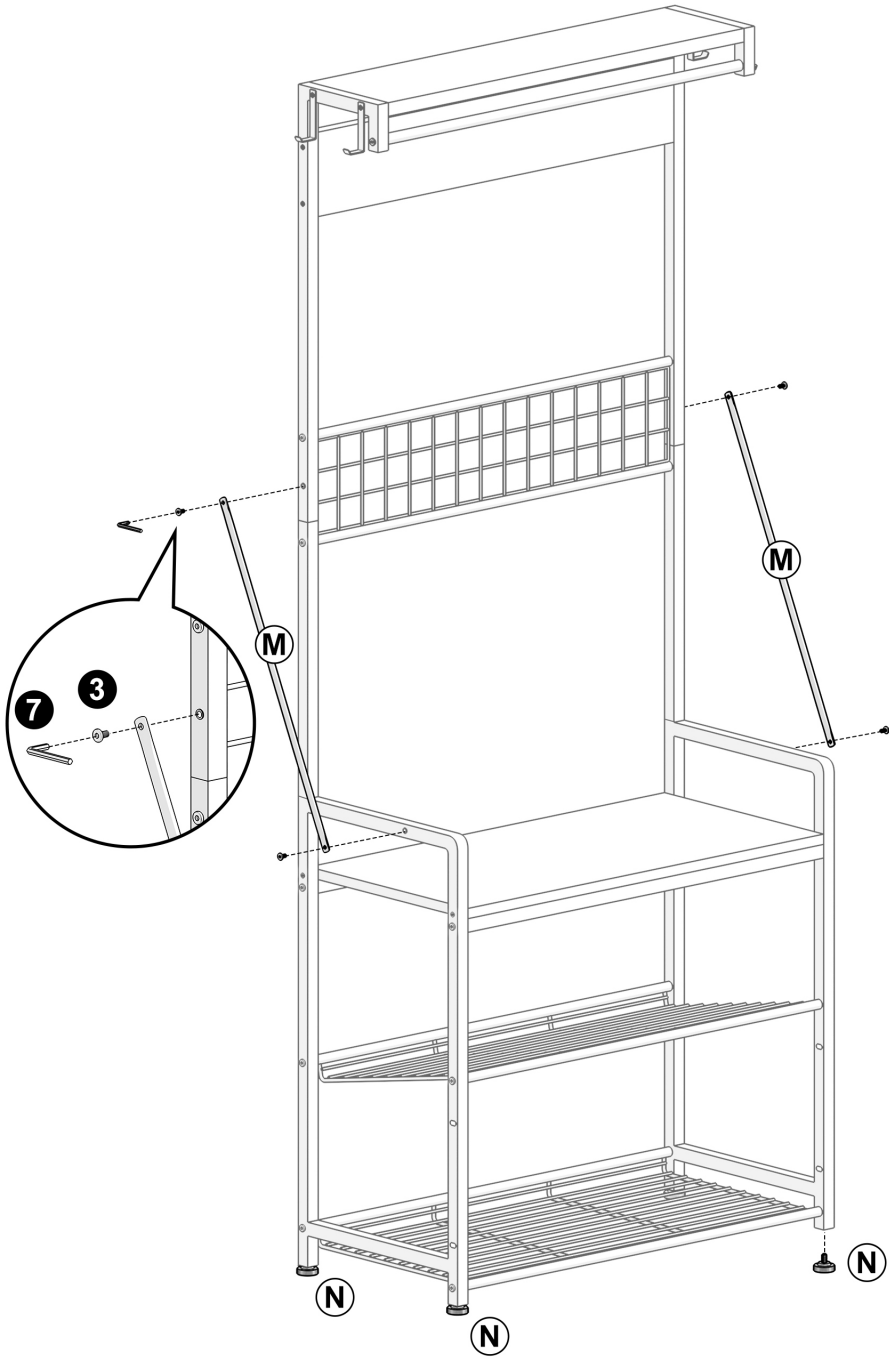

● Step 10

M	N	3	7
			
2 pcs	4 pcs	4 pcs	1 pc

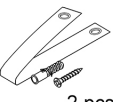

● Step 11

5  5 pcs	6  10 pcs
9  2 pcs	

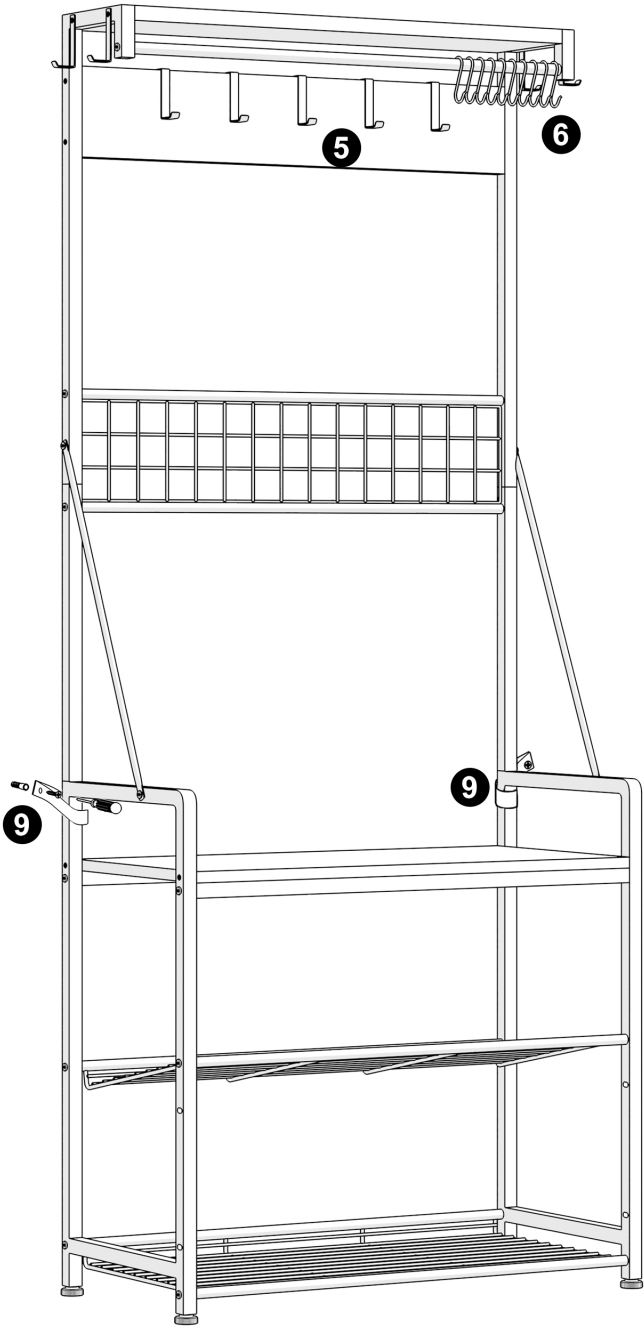

Complete assembly!