

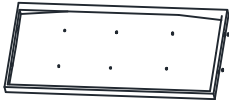

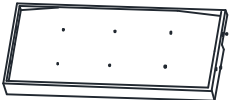

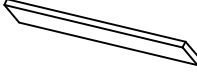
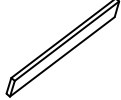

ASSEMBLY INSTRUCTIONS

EASTERN KING HEADBOARD

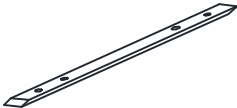
A Upper Part of Headboard  1pc	B Lower Part of Headboard  1pc	C Left Side Panel  1pc	D Right Side Panel  1pc	E Single-Sided Cover (In other carton)  1pc
F Slat  3pcs	G Bolt 1/4" x 50mm  20pcs	H Lock Washer 1/4"  20pcs	I Flat Washer 1/4"  20pcs	J Allen Wrench 1/4"  1pc

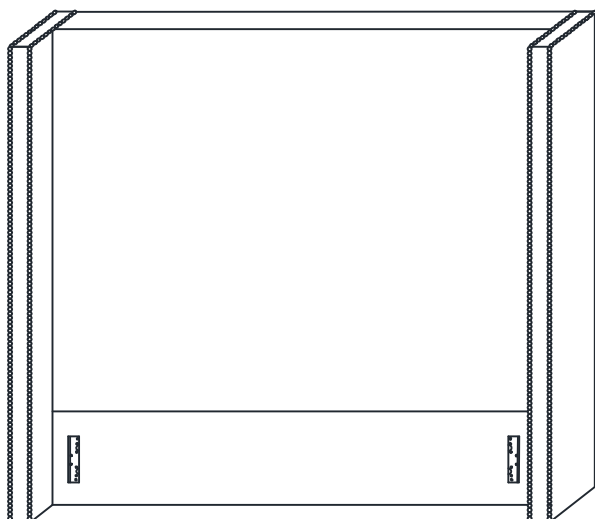

This page lists all the contents included in the box. Please take the time to identify the hardware as well as the individual components to this product. As you unpack and prepare for assembly, place the contents on a carpeted or padded area to protect them from damage.

Notice: This product requires more than two people for assembly.

- 1 Attach Slat (F) to Upper & Lower Part of Headboard (A & B) using Bolt (G), Lock Washer (H) and Flat Washer (I) with Allen Wrench (J).

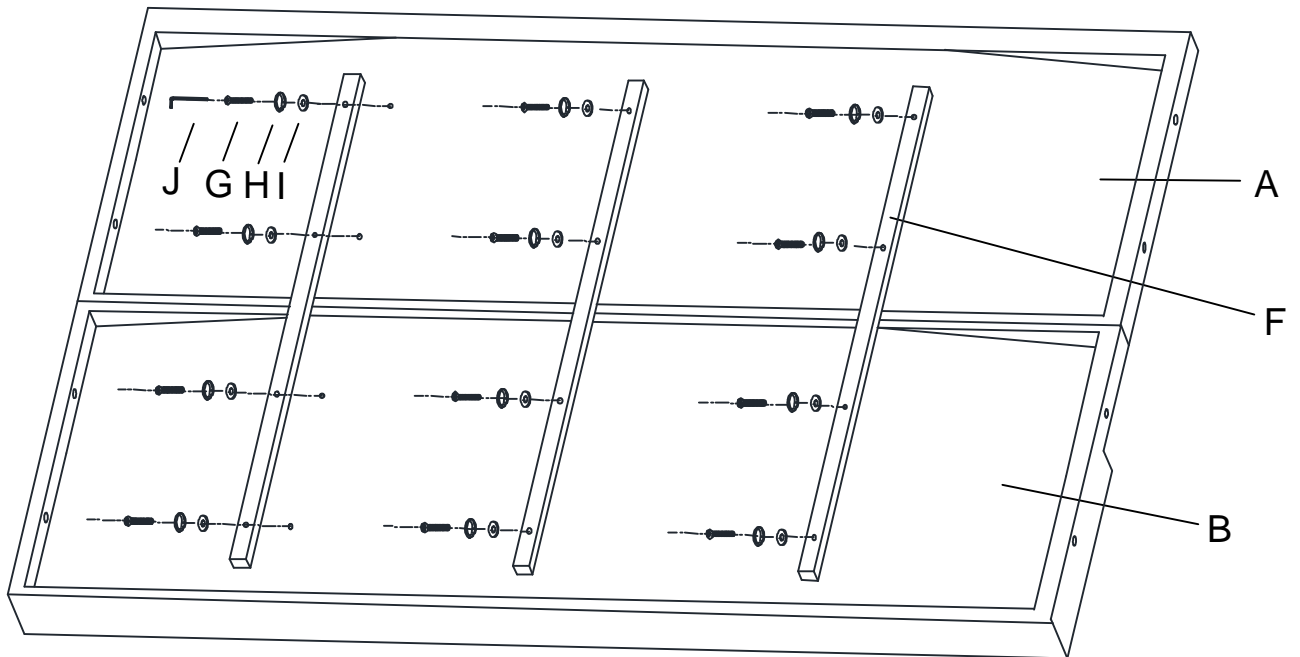

- 2 Place Single-Sided Cover (E) on the front of Headboard (A & B), then attach the Velcro at the back of Headboard (A & B).

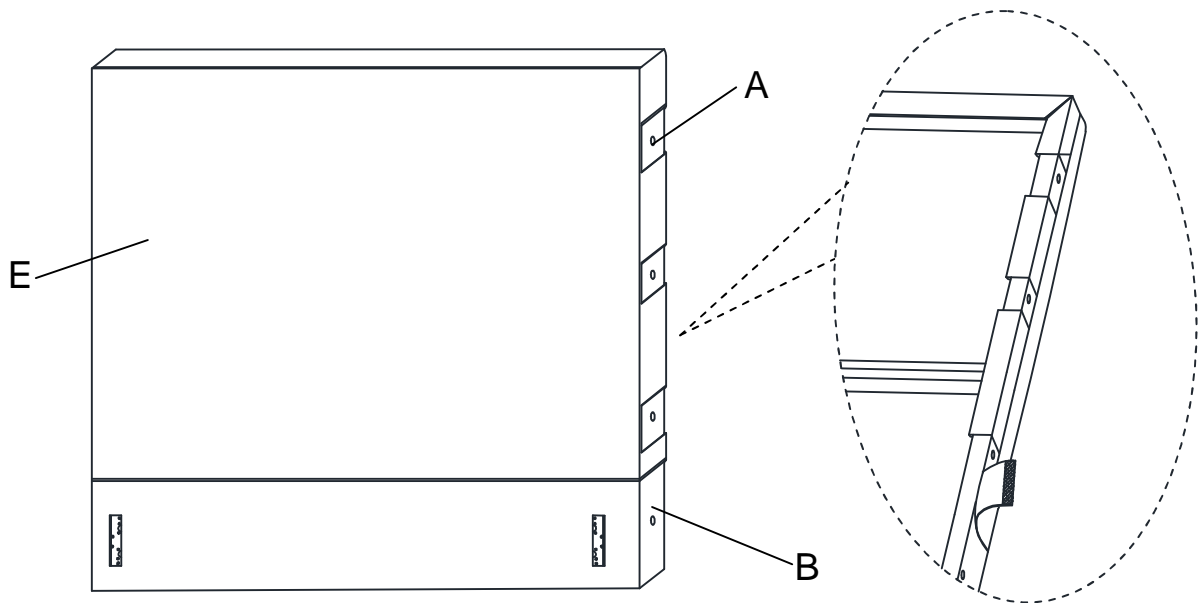

- 3** Attach Left & Right Side Panel (C & D) to Headboard (A & B) using Bolt (G), Lock Washer (H) and Flat Washer (I) with Allen Wrench (J).

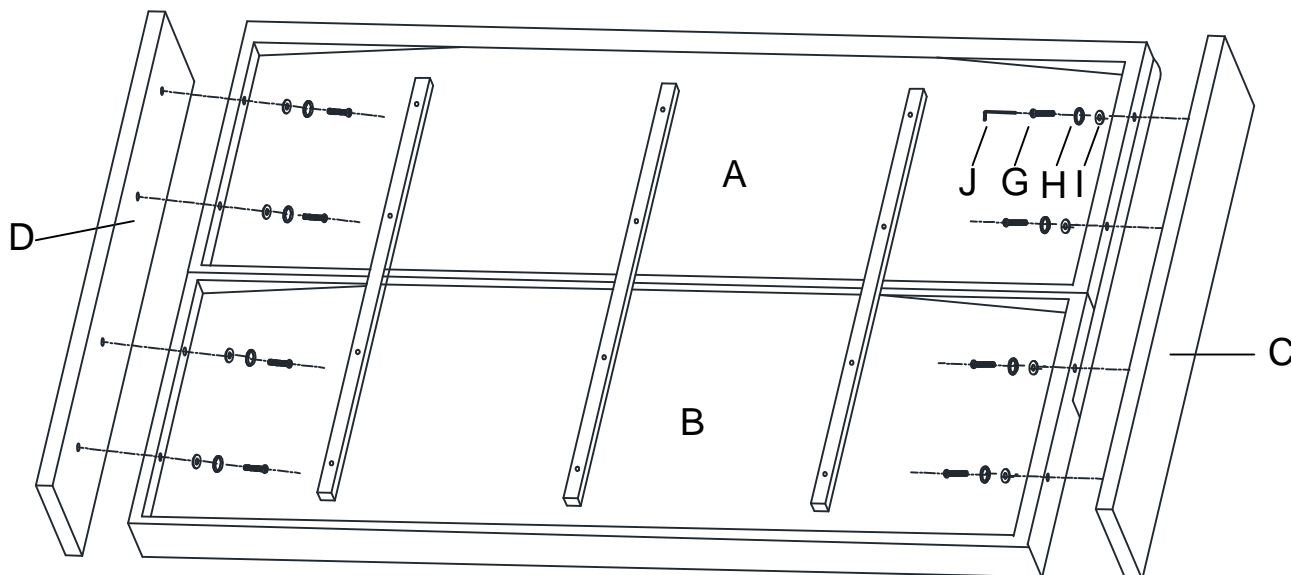

Helpful Tip:

- After assembly, if fabric is not smooth or wrinkled, please iron it.

Cleaning & Care

Treat surfaces with care. Surfaces are resistant to scratches but are not scratch resistant. Clean surfaces with a dry or damp soft cloth. Do not use abrasive cleaners. Hardware may loosen over time. Periodically check that all connections are tight.