

Drawer Chest

EN

Thank you for purchase on our products. Please contact us if you have difficulty with assembly or need replacement parts. Our customer service is here to assist you. Please attach your User Name or Order ID so that we can assist you better.

WARNING

Serious or fatal injury may occur from unexpected assembly or use.

1. During the assembly process, keep all parts away from babies or children.
2. Always securely fix this product to the wall. Make sure the wall area to be drilled is free from hidden electrical wires, water and gas pipes.
3. Use of tip-over restraints may only reduce, but not eliminate the risk of tip-over.
4. Unless specially designed to accommodate, do not set heavy objects on top of this product.
5. Place the heaviest items on the lowest shelf.
6. Never allow children to climb or bang on drawers, doors or shelves.

DE

Vielen Dank für Ihren Kauf von uns Produkten. Bitte kontaktieren Sie uns, wenn Sie Probleme mit Montage haben oder Ersatzteile benötigen. Wir Kundenservice ist für Sie da. Bitte geben Sie Ihren Benutzernamen oder Ihre Bestellnummer an, damit wir Sie besser unterstützen können.

WARNUNG



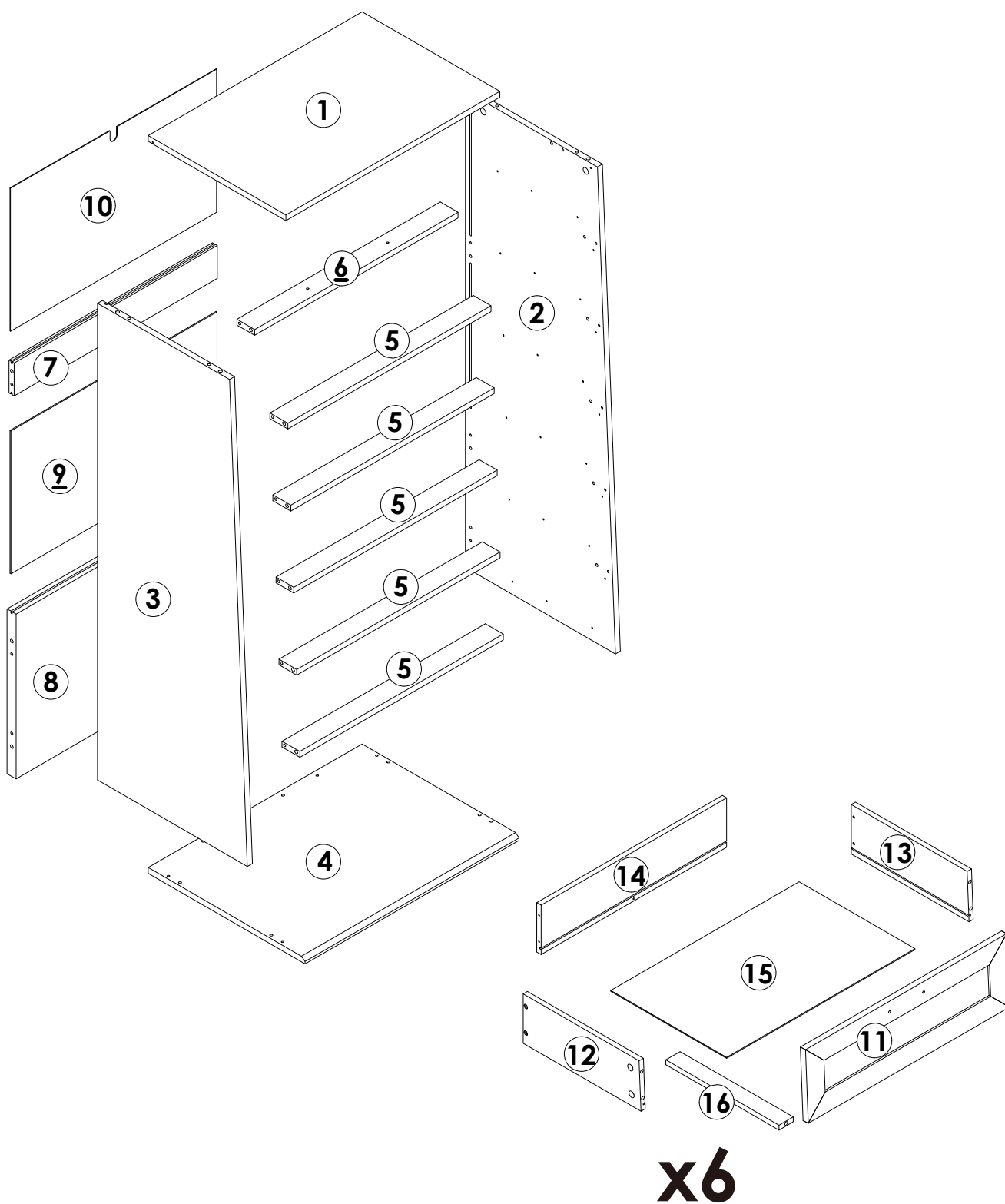

Bei unerwarteter Montage oder Verwendung können schwere oder tödliche Verletzung auftreten.

1. Legen Sie in den Montageprozess alle Teile weg von Babys oder Kindern.
2. Stellen Sie sicher, dass der gebohrte Wandbereich frei von verborgenen Stromkabeln, Wasser- und Gasleitungen ist, wenn Sie dieses Produkt an der Wand befestigen.
3. Die Verwendung von Kippsicherungen kann die Gefahr eines Kippens nur verringern, jedoch nicht beseitigen.
4. Setzen Sie bitte keine schweren Gegenstände auf dieses Produkt, es sei denn, dass das Produkt speziell für die Unterbringung konzipiert wird.
5. Legen Sie bitte die schwersten Gegenstände auf das unterste Regal.
6. Erlauben Sie nie Kindern, auf Schubladen, Türen oder Regale zu klettern oder zu knallen.

Parts List(EN) / Teile Liste(DE)

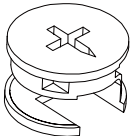

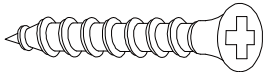
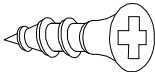
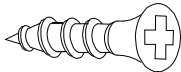
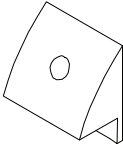
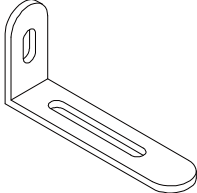
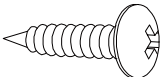
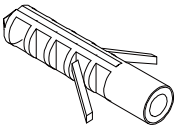
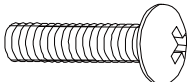
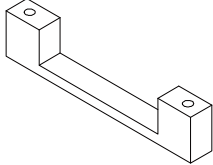
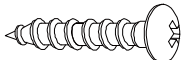
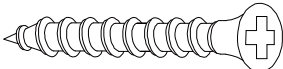

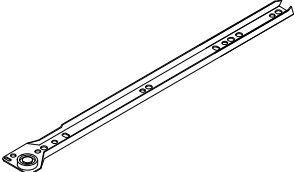
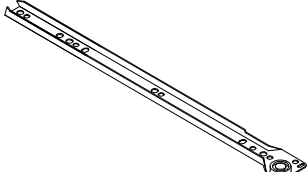
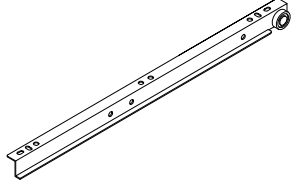
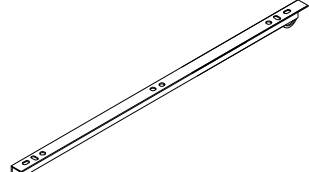

Parts List(EN) / Teile Liste(DE)

| | | | |
|---|---|---|--|
| <p>A</p>  <p>M6×34mm 52+2PCS</p> | <p>B</p>  <p>Ø15×9mm 52+2PCS</p> | <p>C</p>  <p>Ø6×30mm 28+2PCS</p> | |
| <p>D</p>  <p>M4×30mm 12+1PCS</p> | <p>E</p>  <p>M3×12mm 72+2PCS</p> | <p>F</p>  <p>M3×15mm 8+1PCS</p> | |
| <p>G</p>  <p>8+1PCS</p> | <p>L</p>  <p>1PC</p> | <p>M</p>  <p>M4×12mm 1PC</p> | |
| <p>N</p>  <p>Ø6×30mm 1PC</p> | <p>O</p>  <p>M4×19mm 12+1PCS</p> | <p>P</p>  <p>6PCS</p> | |
| <p>Q</p>  <p>M4×20mm 2PCS</p> | <p>R</p>  <p>M4×35mm 37+2PCS</p> | <p>S</p>  <p>12PCS</p> | |
| <p>CL</p>  <p>L300mm 6PCS</p> | <p>CR</p>  <p>L300mm 6PCS</p> | <p>DL</p>  <p>L300mm 6PCS</p> | <p>DR</p>  <p>L300mm 6PCS</p> |

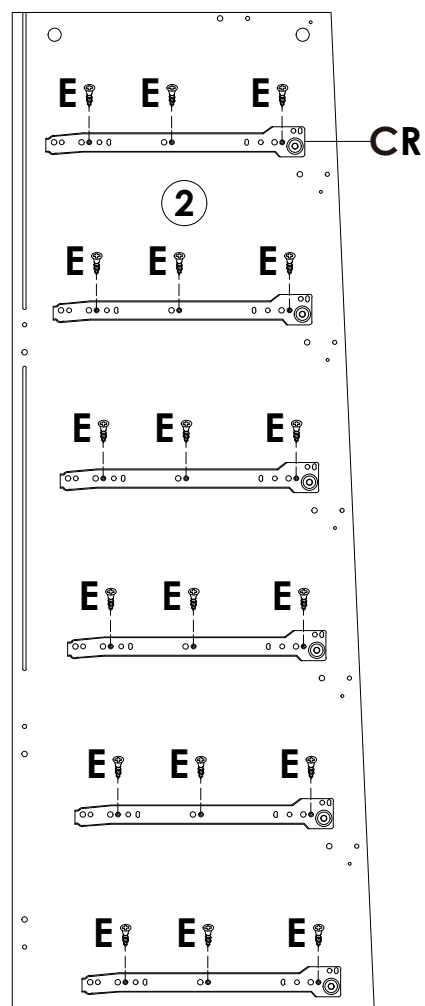
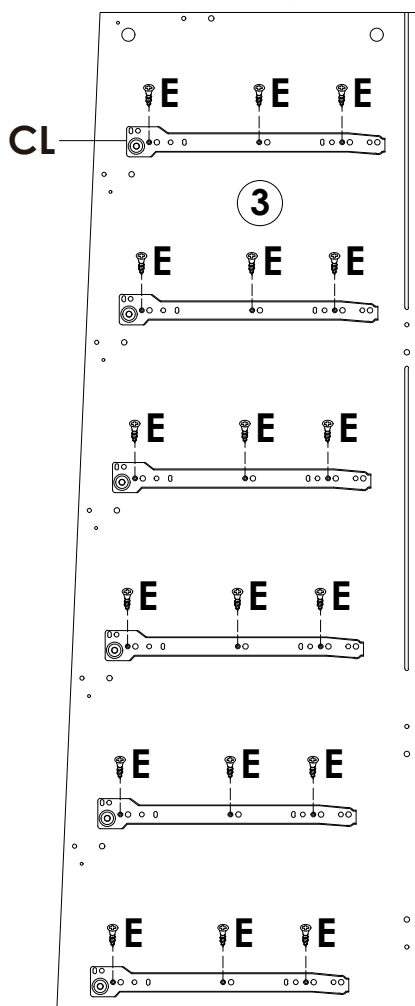
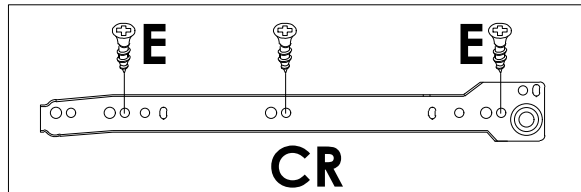
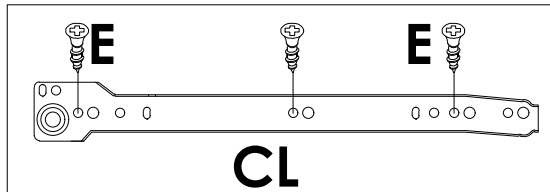
Assembly Steps(EN) / Montageschritte(DE)

STEP 1



| | |
|---|------------------|
|  | E x 36PCS |
|  | CL x 6PCS |
|  | CR x 6PCS |

Assembly Steps(EN) / Montageschritte(DE)

STEP 2

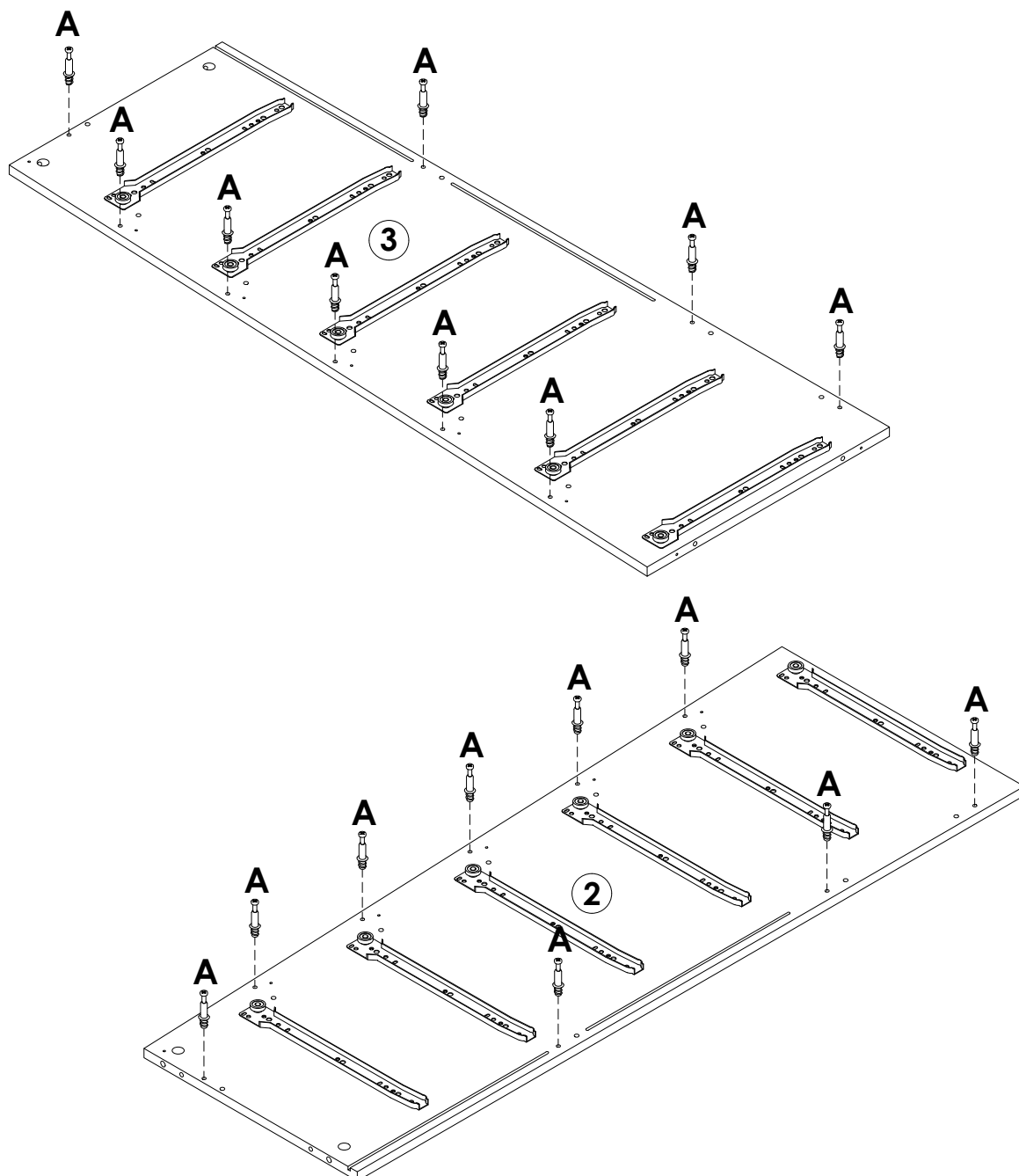



 **A x 18PCS**

Assembly Steps(EN) / Montageschritte(DE)

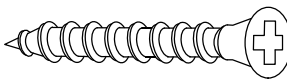
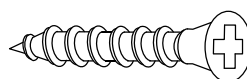
STEP 3

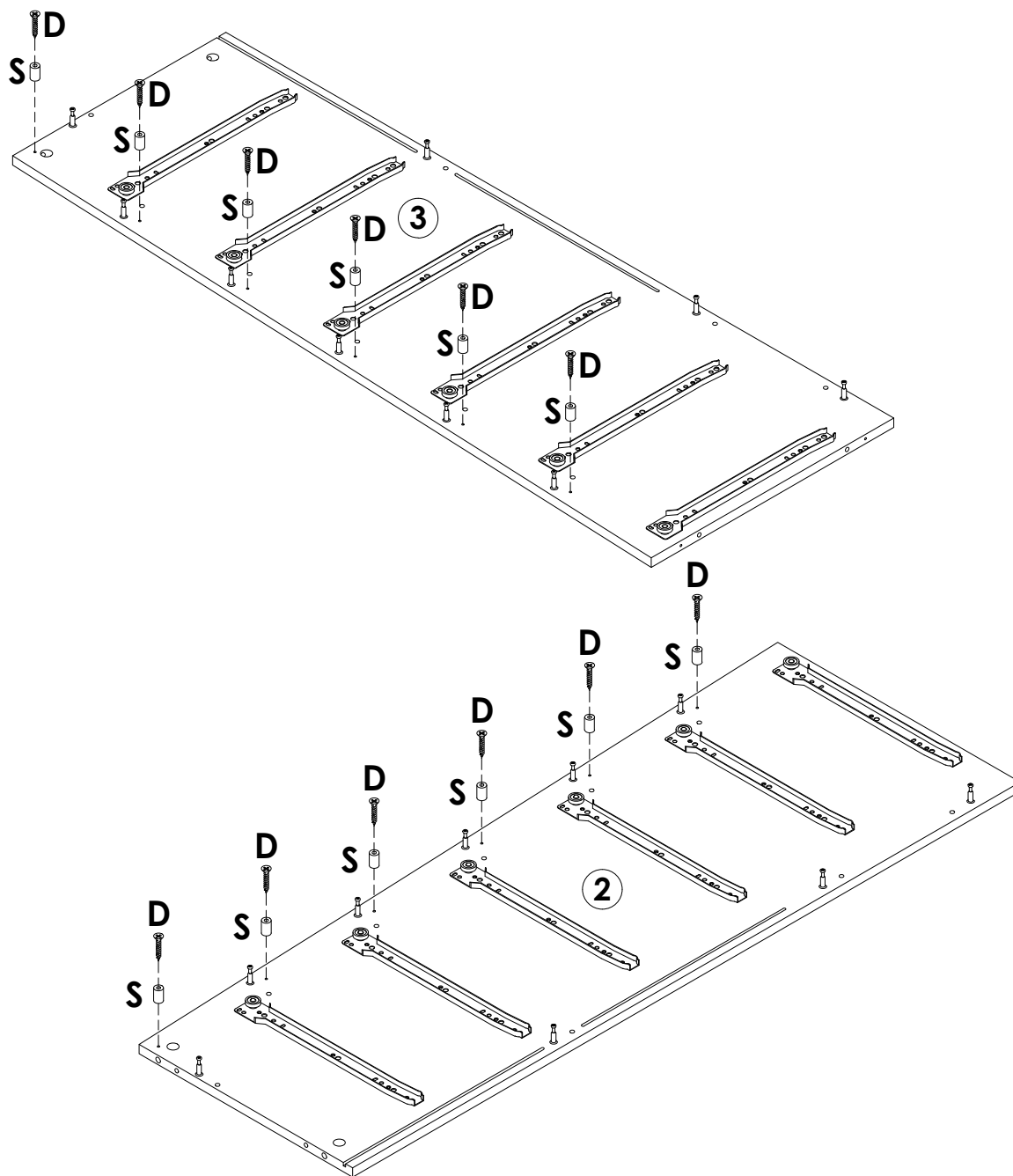
| | | |
|----------|--|----------|
| R |  | X |
| M4x35mm | | |
| D |  | ✓ |
| M4x30mm | | |





| | |
|---|------------------|
|  | S x 12PCS |
|  | D x 12PCS |

Assembly Steps(EN) / Montageschritte(DE)

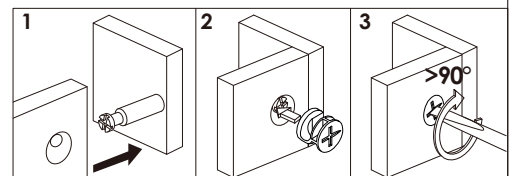
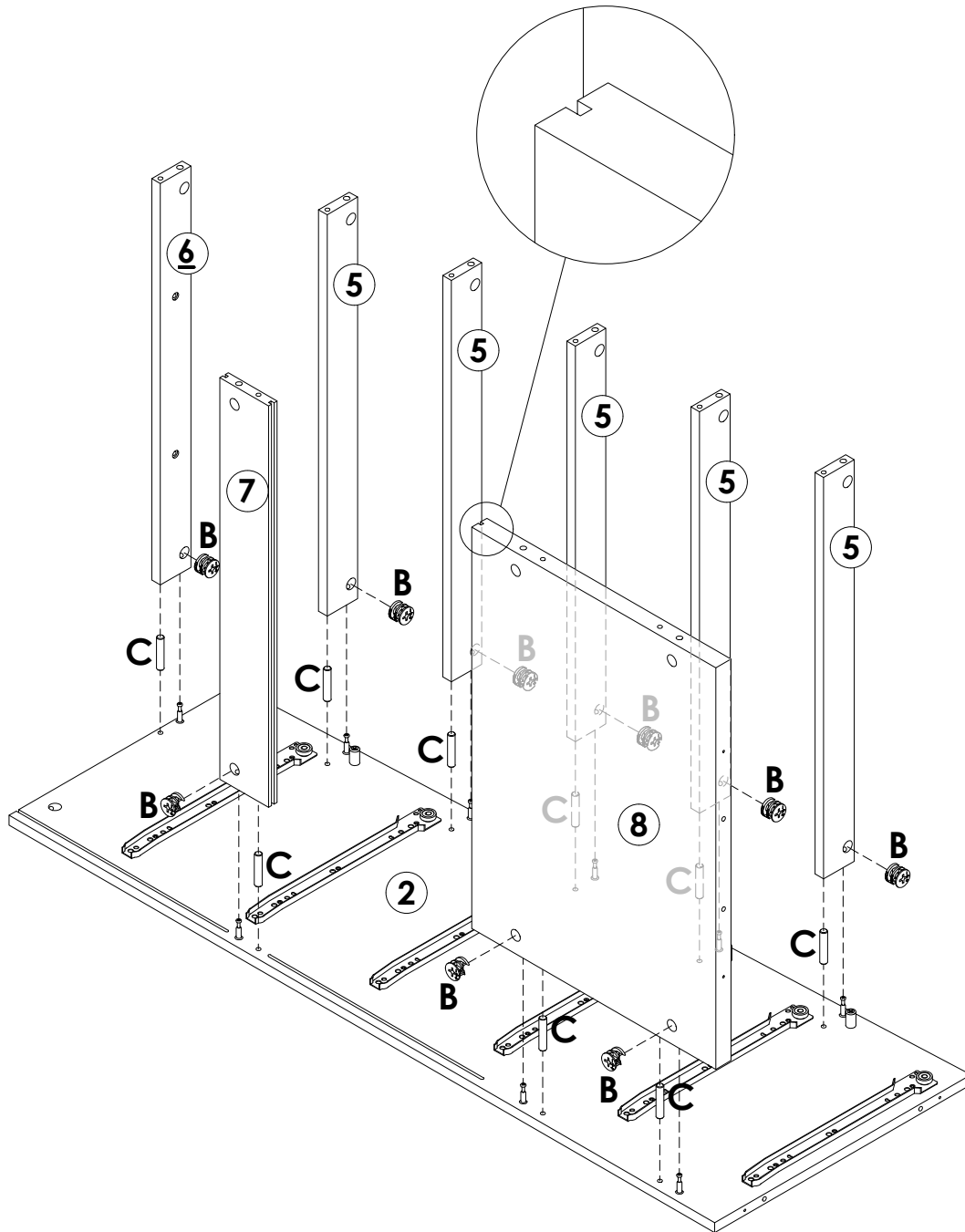
STEP 4



| | |
|---|-----------------|
|  | B x 9PCS |
|  | C x 9PCS |

Assembly Steps(EN) / Montageschritte(DE)

STEP 5

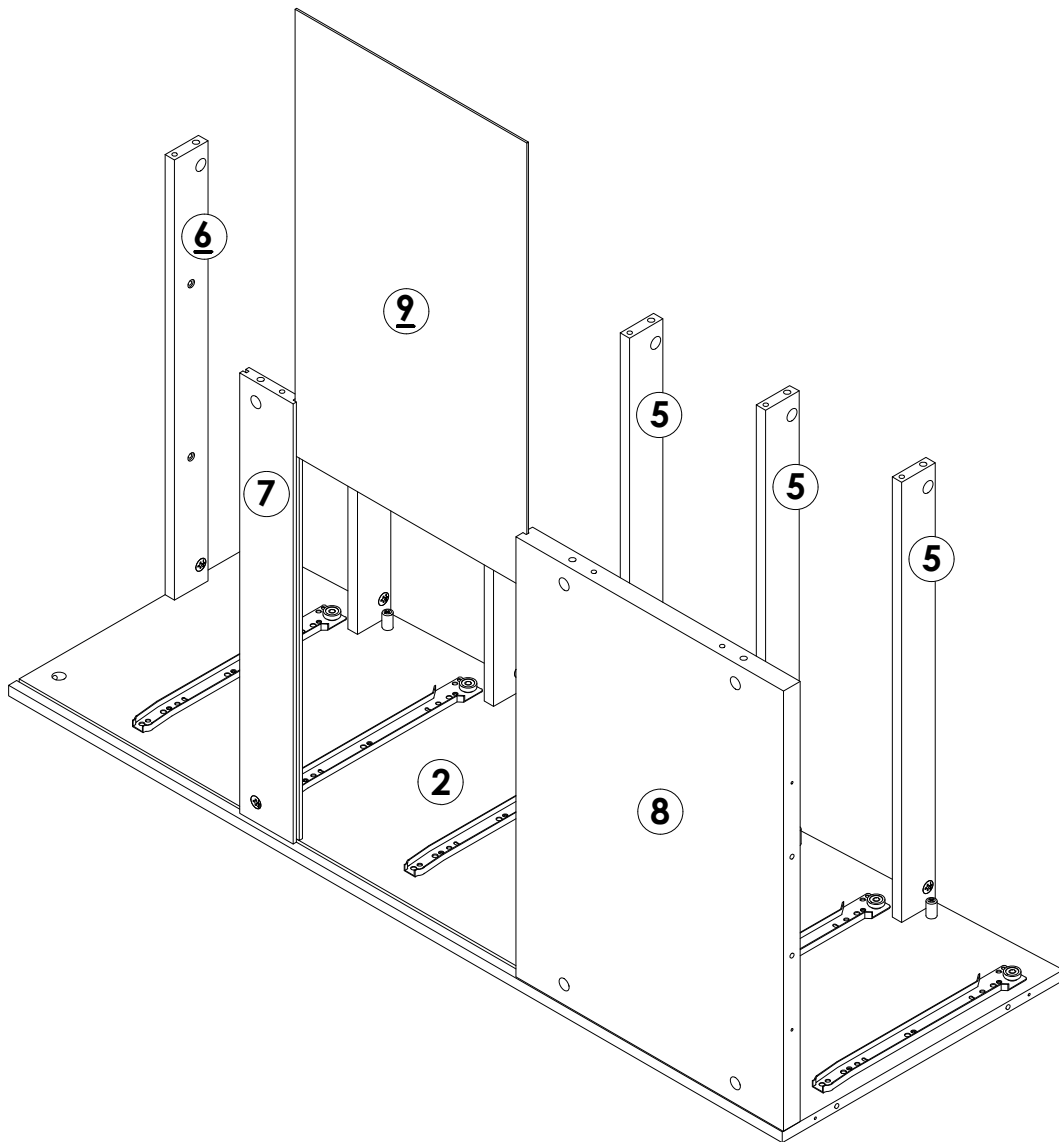

Assembly Steps(EN) / Montageschritte(DE)

STEP 6

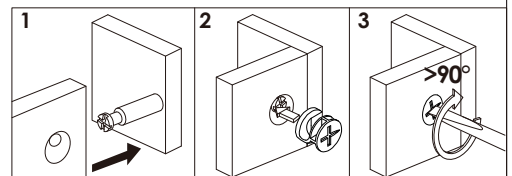
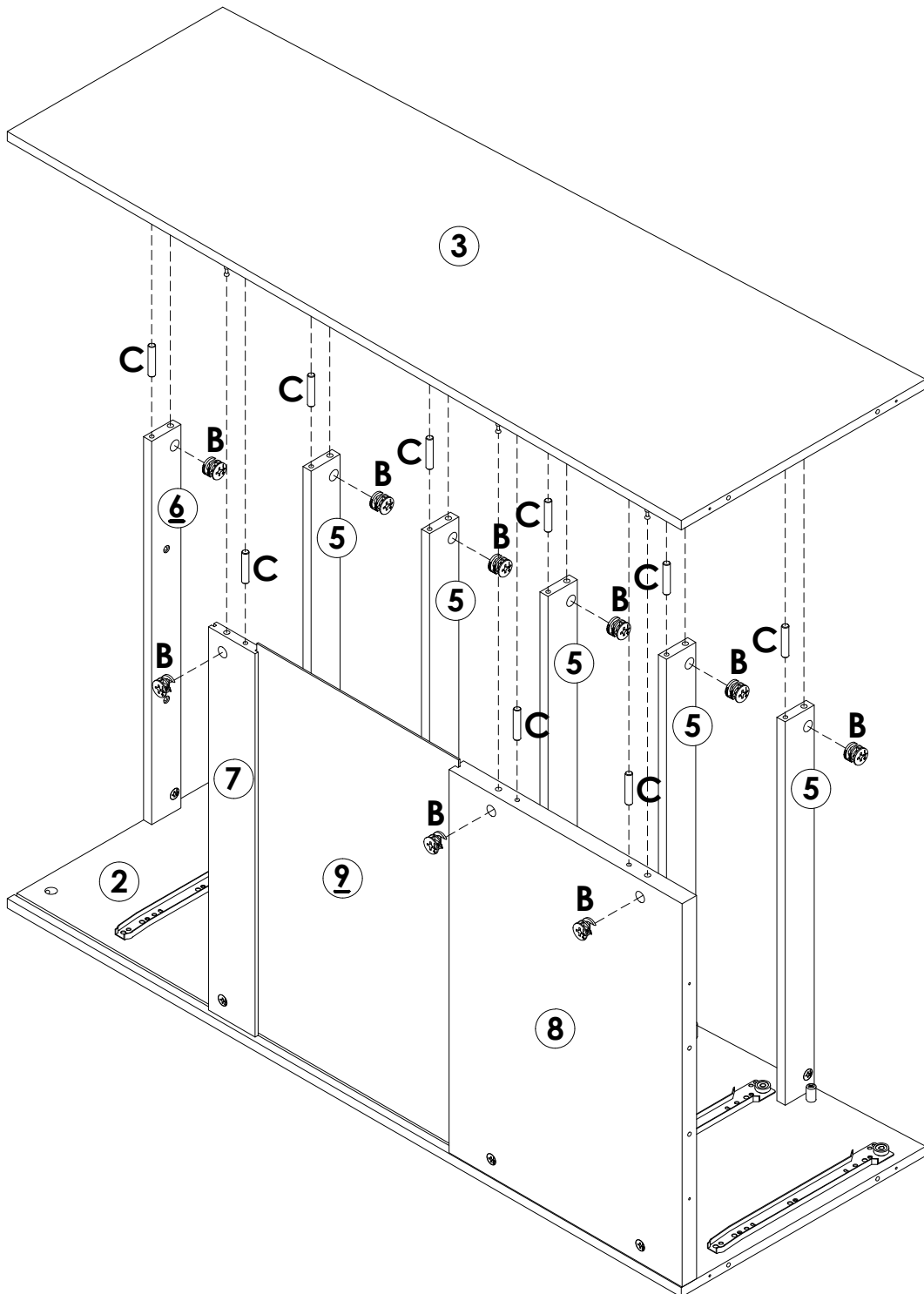

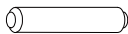
| | |
|---|-----------------|
|  | B x 9PCS |
|  | C x 9PCS |

Assembly Steps(EN) / Montageschritte(DE)

STEP 7

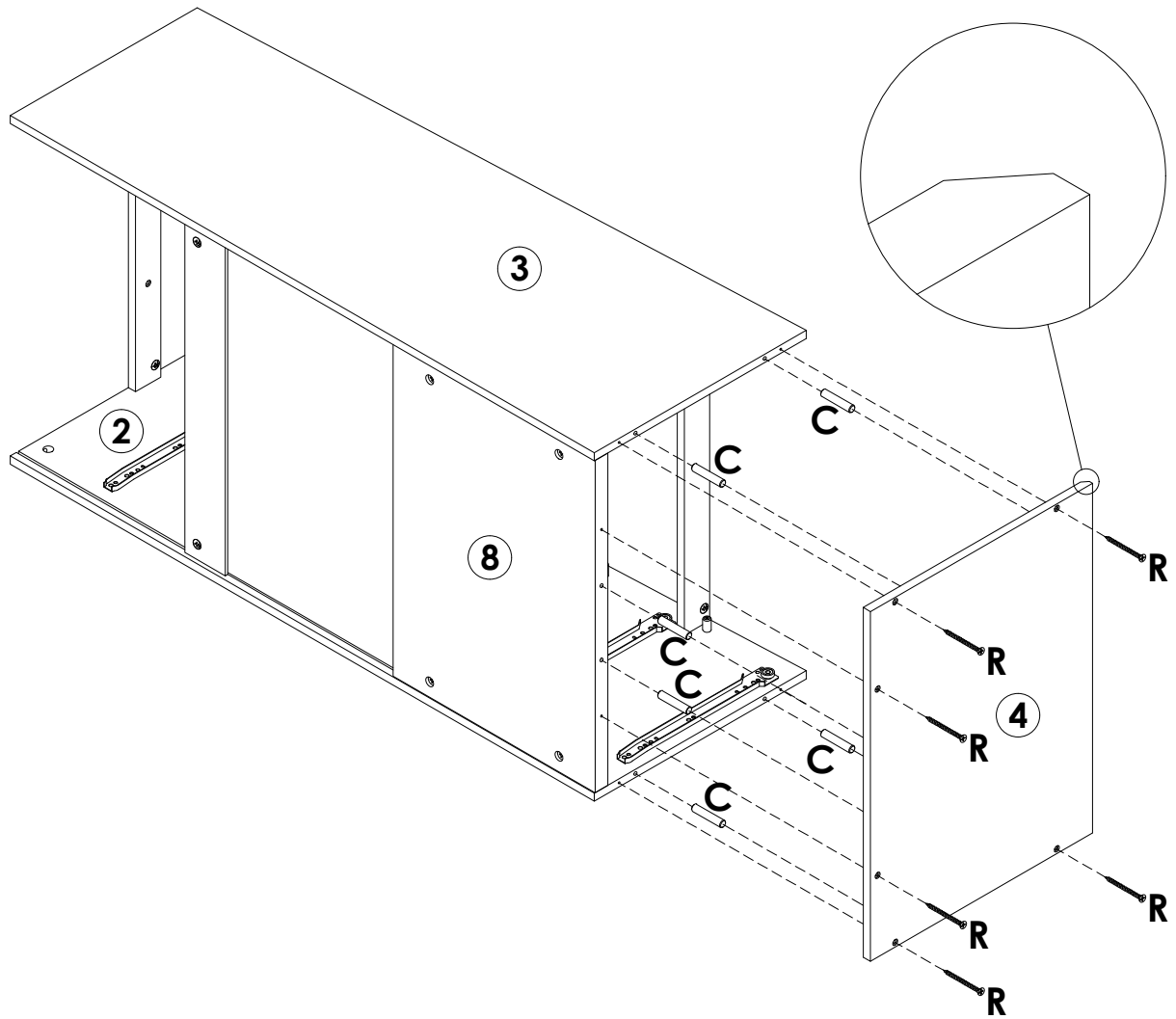

| | |
|---|-----------------|
|  | C x 6PCS |
|  | R x 6PCS |

Assembly Steps(EN) / Montageschritte(DE)

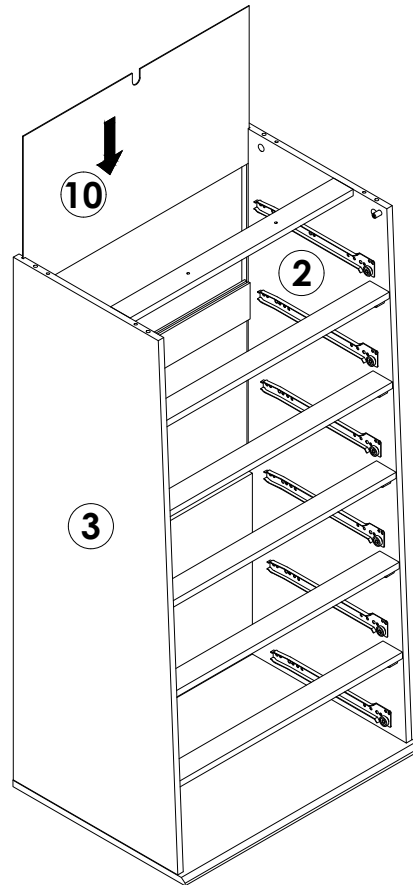

STEP 8

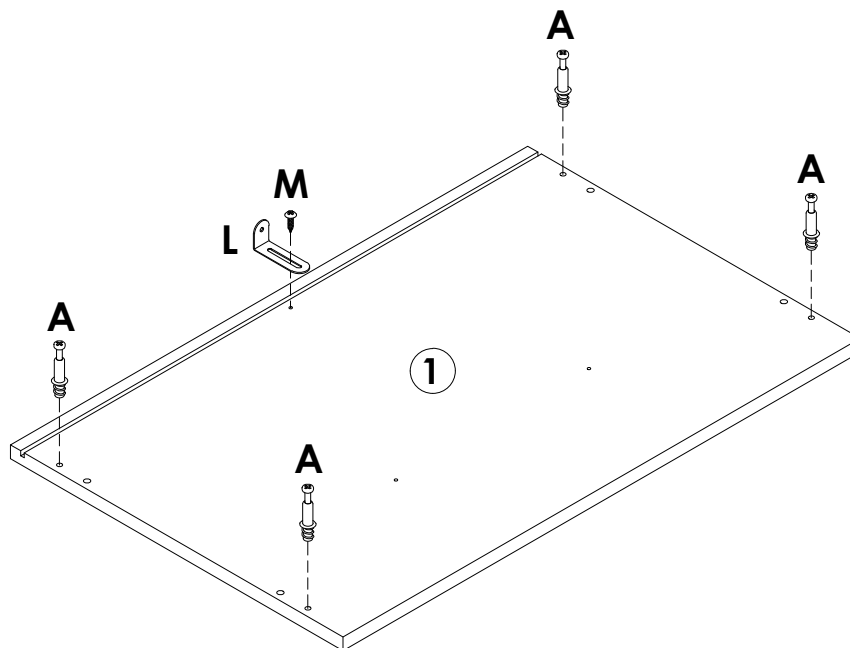

STEP 9

Lock the long side of the "L" L-shaped metal plate to the ① board with the "M" short screw.

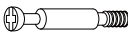

| | |
|---|----------|
|  | A x 4PCS |
|  | M x 1PC |
|  | L x 1PC |

Assembly Steps(EN) / Montageschritte(DE)

STEP 10

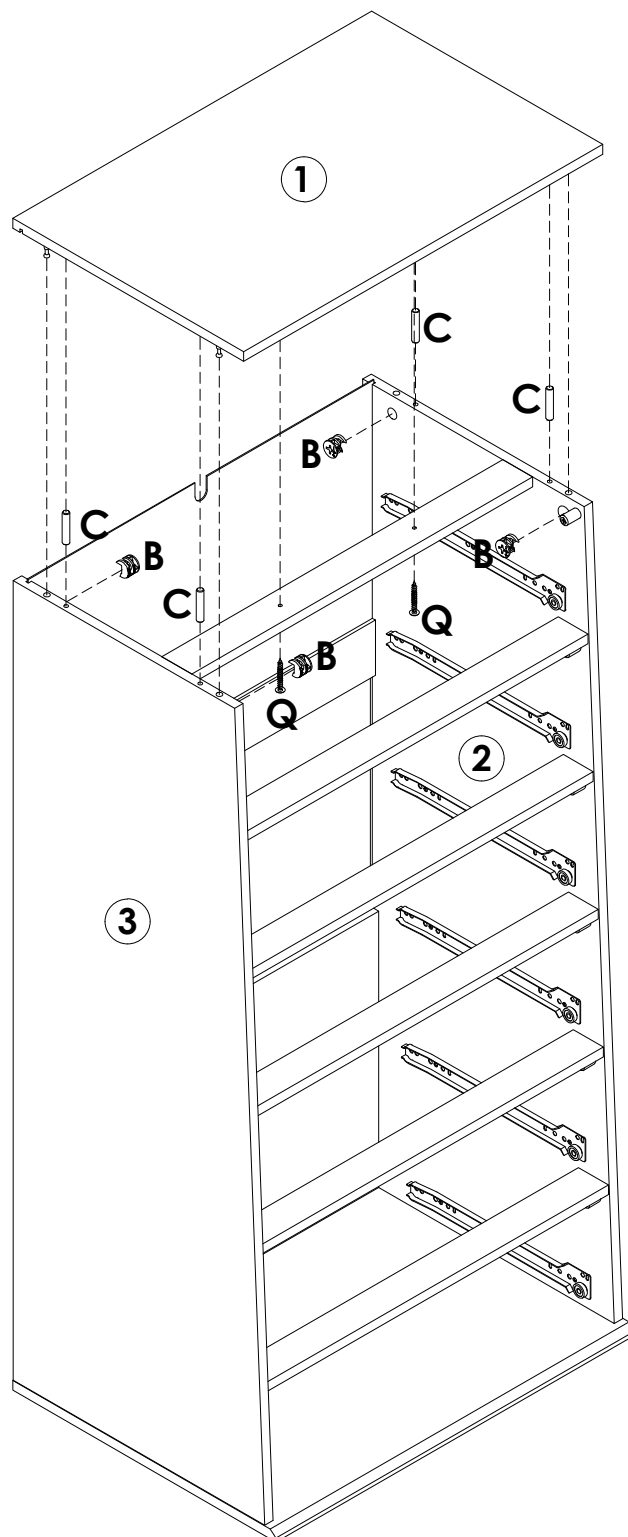

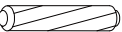
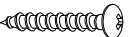

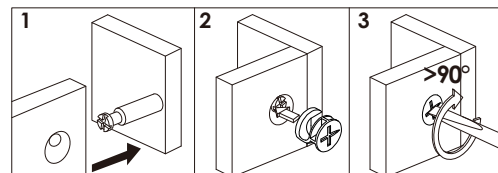
| | |
|---|-----------------|
|  | B x 4PCS |
|  | C x 4PCS |
|  | Q x 2PCS |

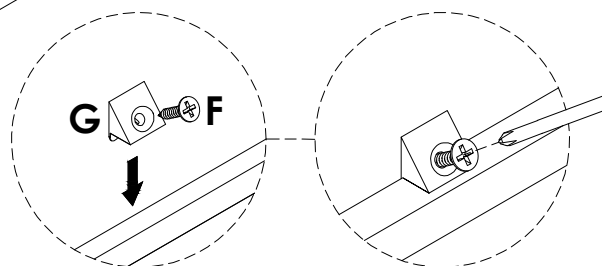
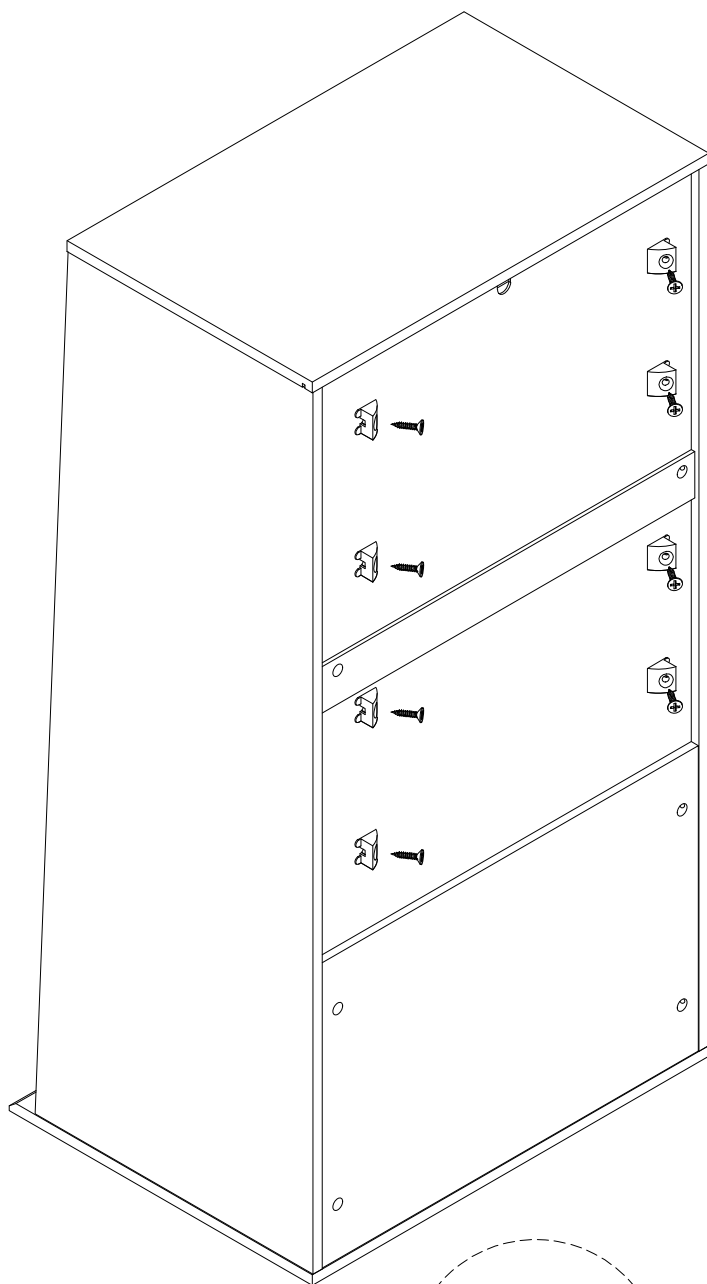

Assembly Steps(EN) / Montageschritte(DE)

STEP 11



| | |
|---|-----------------|
|  | F x 8PCS |
|  | G x 8PCS |

Assembly Steps(EN) / Montageschritte(DE)

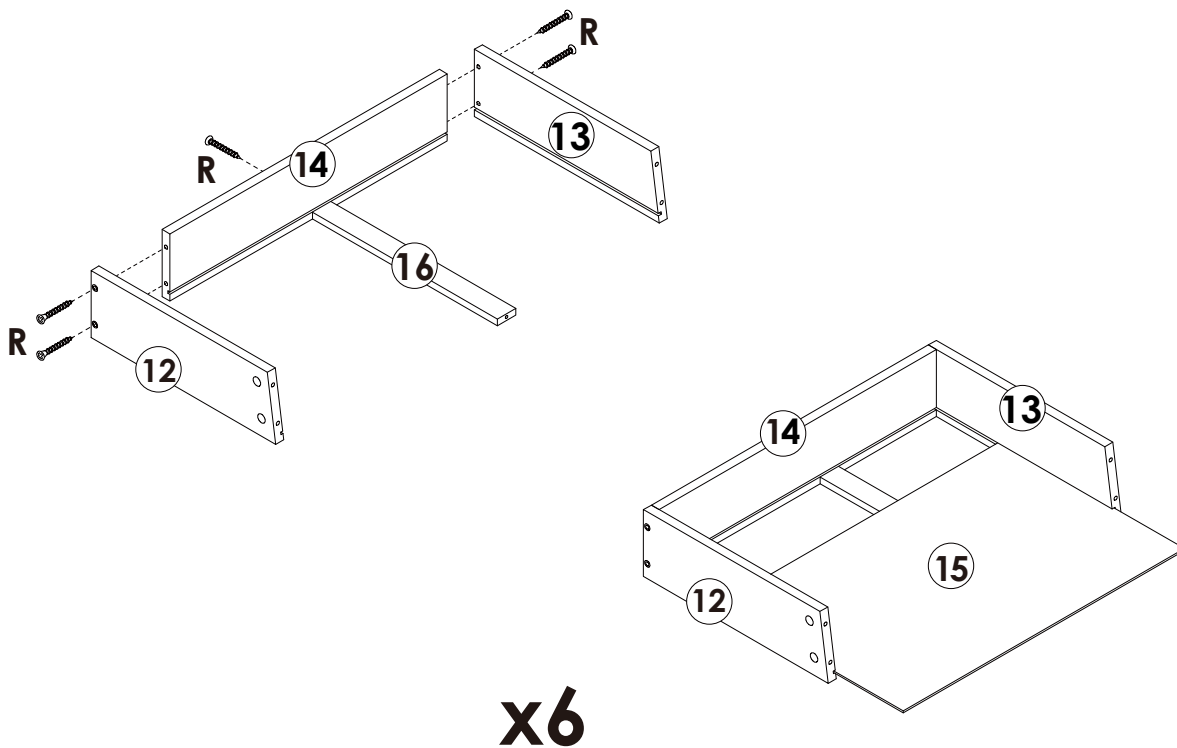

STEP 12

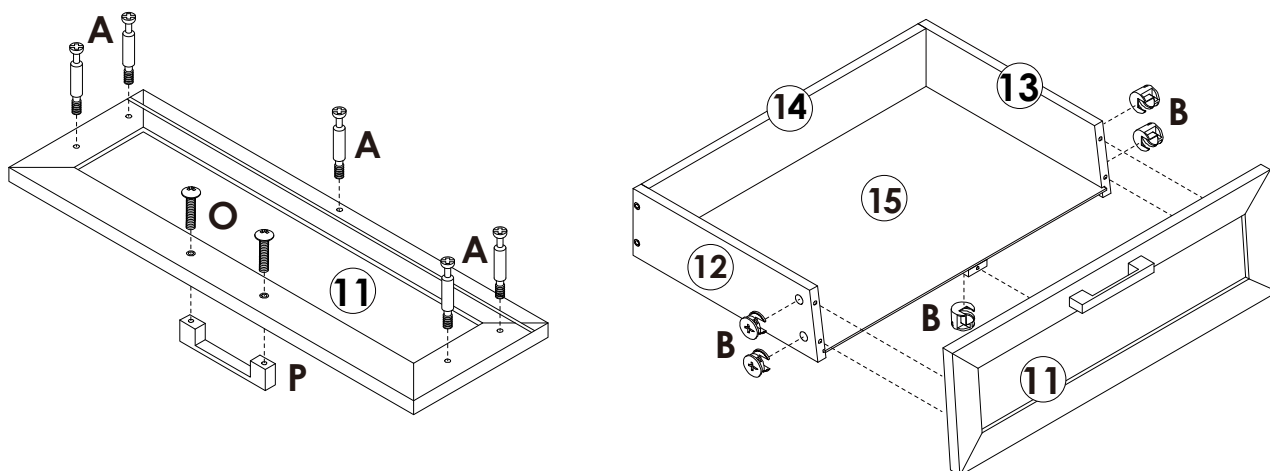

 R x 30PCS

STEP 13

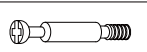

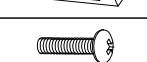

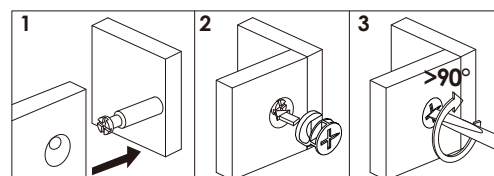

| | |
|---|-----------|
|  | A x 30PCS |
|  | B x 30PCS |
|  | P x 6PCS |
|  | O x 12PCS |

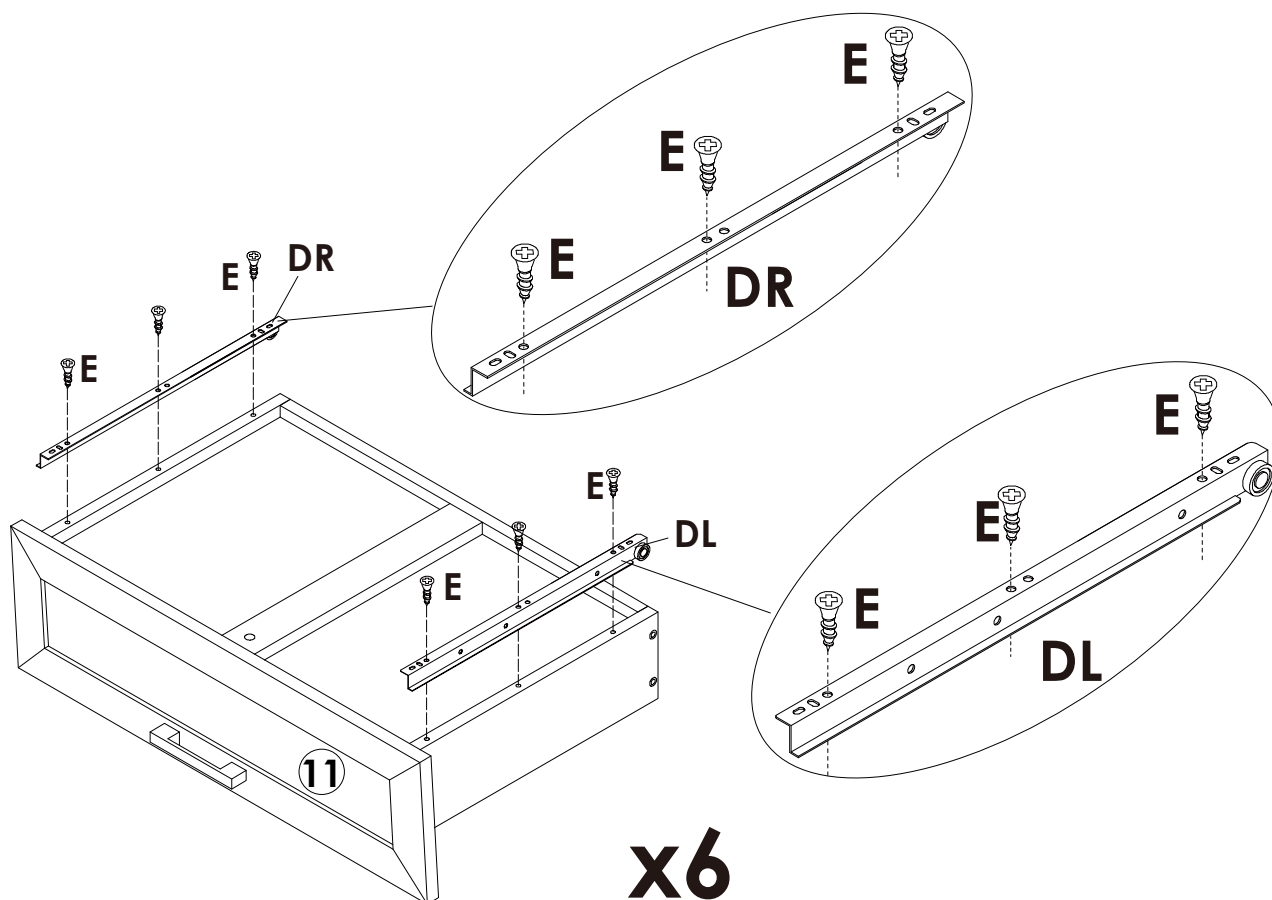

Assembly Steps(EN) / Montageschritte(DE)

STEP 14



| | |
|---|-----------|
|  | E x 36PCS |
|  | DL x 6PCS |
|  | DR x 6PCS |

STEP 15

Drill a hole on the wall at the required position for anti-falling device installation.

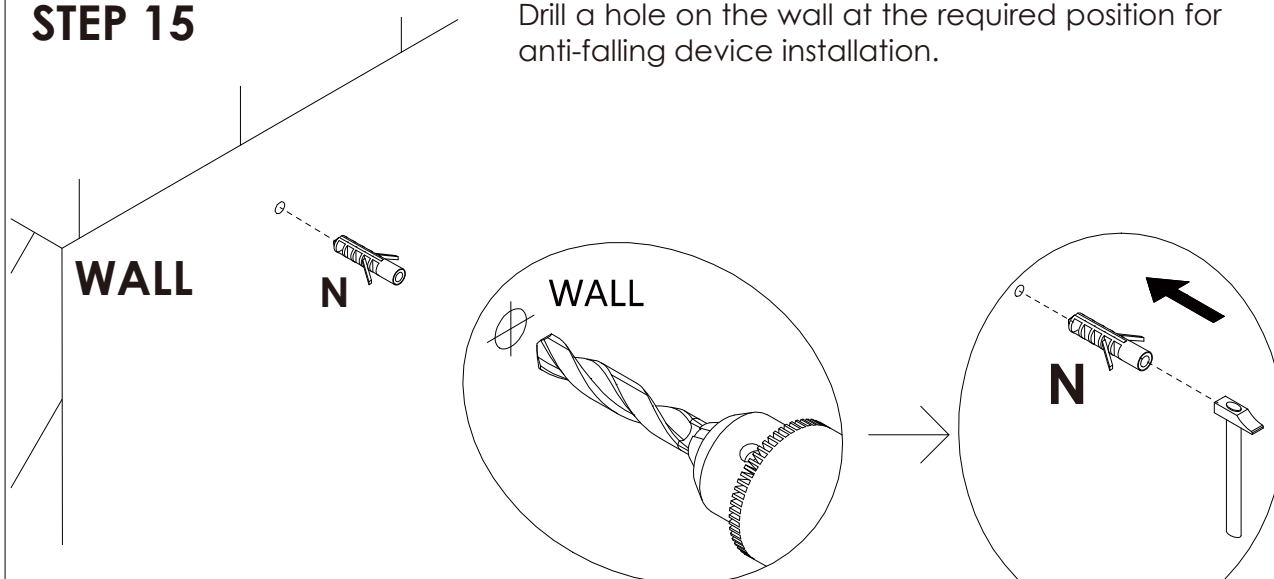

| | |
|---|---------|
|  | N x 1PC |
|---|---------|

Assembly Steps(EN) / Montageschritte(DE)

STEP 16

Move the cabinet to the required position, use the "R" long screw to fix the cabinet to the wall.

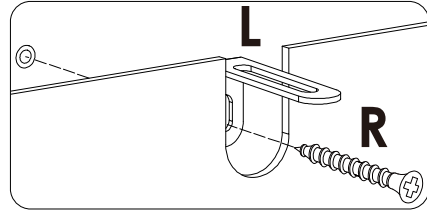

WALL

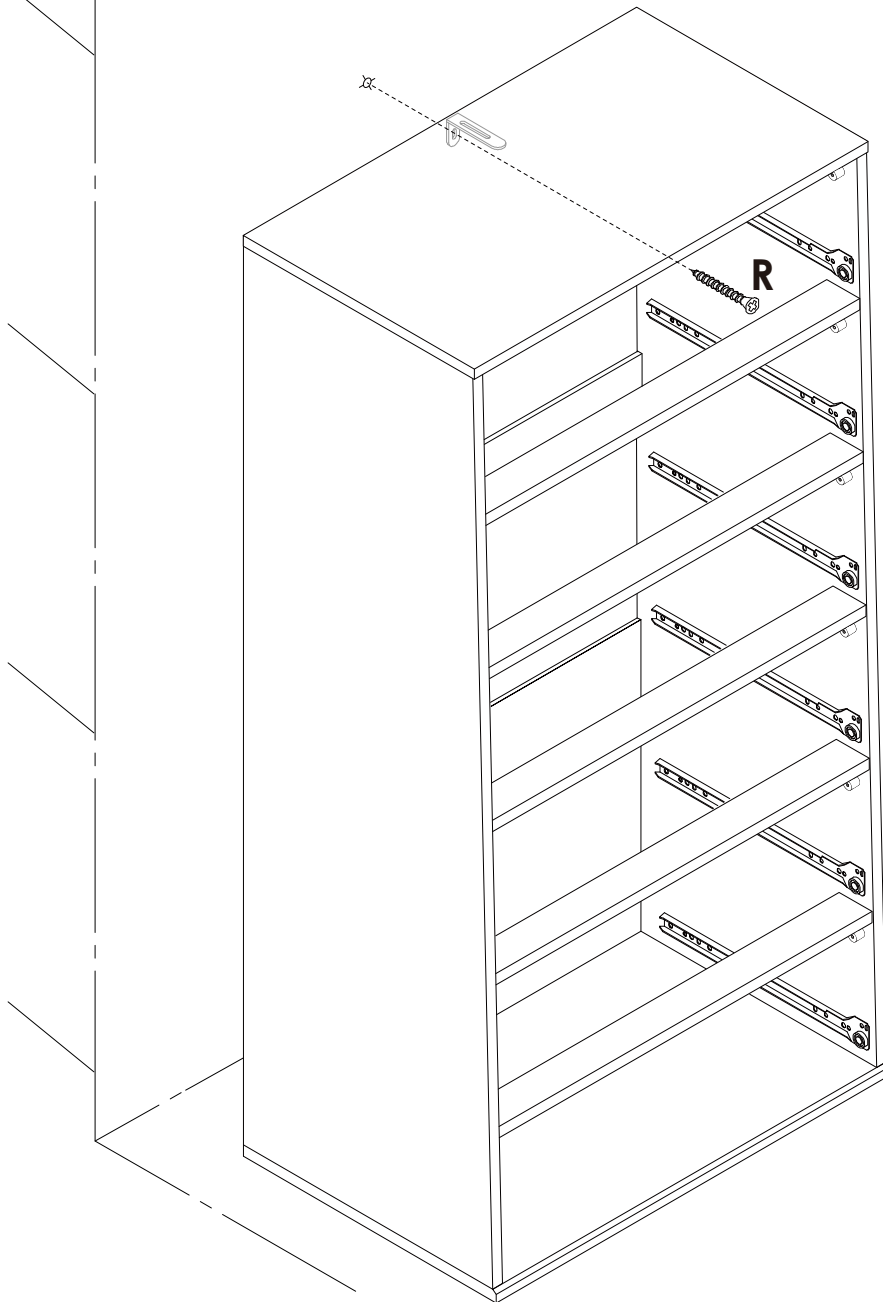

 **R x 1PC**

Assembly Steps(EN) / Montageschritte(DE)

STEP 17

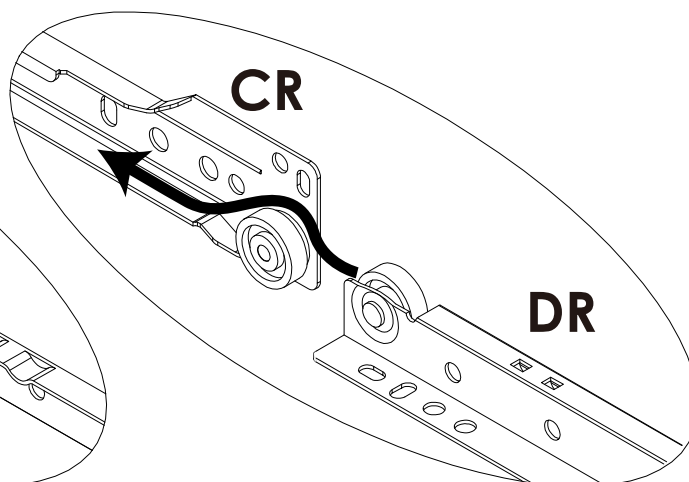
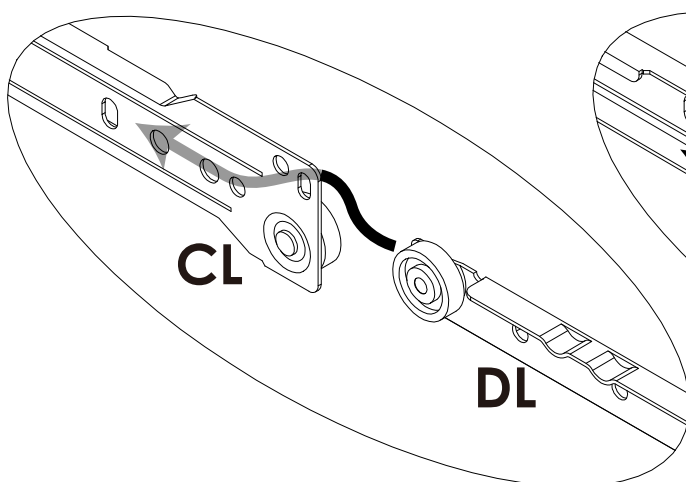
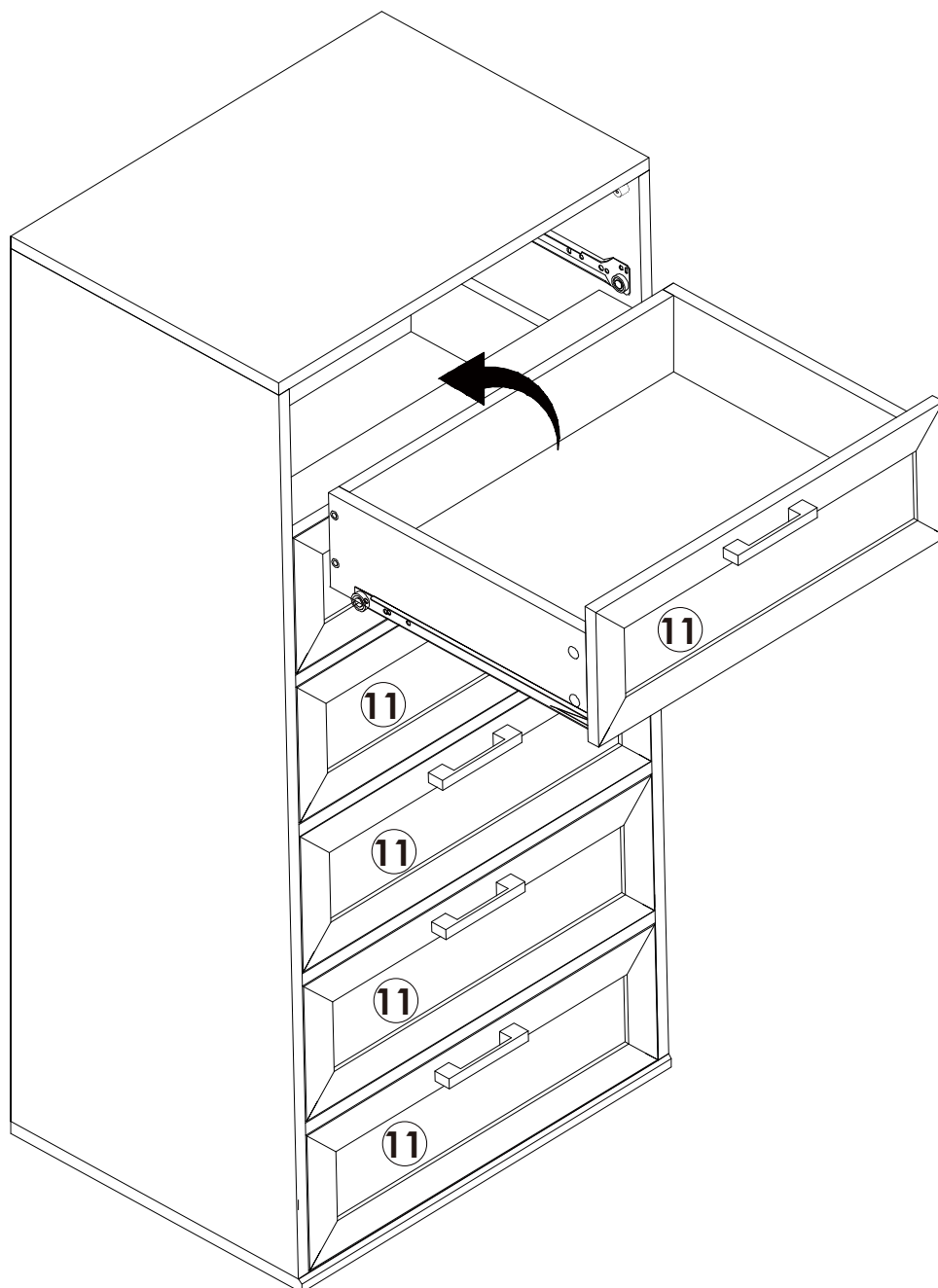



WARNING



Children have died from furniture tipover. To reduce the risk of furniture tipover:

- **ALWAYS** install Anti-tip device provided.
- **NEVER** put a TV on this product.
- **NEVER** allow children to stand, climb or hang on any drawers, doors, or shelves.
- **NEVER** open more than one drawer at a time.
- Place heaviest items in the lowest drawers.



***This is a permanent label.
Do not remove!***