

KSHIOE

2mx3m Background Support System and 45W 5500K Umbrellas
Lighting Kit



SAFETY PRECAUTIONS

1. Become thoroughly familiar with this product before use. Run through at least one practice assembly and breakdown before you schedule a shoot.
2. Never leave the lighting unsupervised when in use. Keep children or incompetent person away from lighting equipment.
3. If the power cords show signs of wear or damage, they should be replaced or repaired by a qualified electrician before use.
4. Wait until bulbs are completely cool before touching or removing them.
5. Never use in a wet environment. Never let the product touch the water.
6. Never touch the product when your hands are wet.
7. Never move the appliance by pulling the cord. Make sure the cords do not come in contact with bulbs. Do not wind the cord around the appliance.
8. Place stands/tripods on flat surface to prevent toppling.
9. Do not touch the metal parts near the bulbs while in use, these parts may become very hot.
10. Do not let umbrella touch light bulb when in use. Light bulb will get hot and can ruin the softbox or start a fire.
11. Remember to turn off the power switch before replacing the lamp.

HOW TO REMOVE NON-WOVEN CREASES

Firstly, place the non-woven fabric on a flat and hard surface, spread it flat.

Tips: Usually, this processing method is for the hydrophilic non-woven fabric.

Secondly, find a wet towel and wipe the fabric gently.







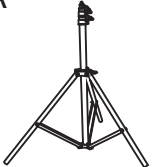

Note: Do not make the towel too wet, wipe the wrinkles several times with the towel.

Thirdly, find something which is almost like the non-woven fabric, such as a bed sheet, press it on the fabric.

Tips: You can put all hydrophilic non-woven fabrics together to save time and effort. It might need to press one day or half a day.

Note: It is not recommended that you wash the fabric, the color will not be as bright as before after washing. Do not iron the non-woven fabric, it may scorch.

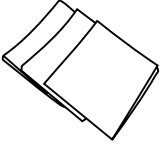
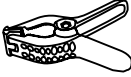
3* 2m light stand(A) 2* 33inch white umbrella(B) 1* 33inch black golden umbrella(C)
 3* single light head(D) 3* 45W bulb(E) 1* carry bag(F) 1* 2X3m background(G+J)
 3* 1.6X3m fabric backdrop (H) 3* clamps(I)

<p>A</p>  <p>3pcs</p>	<p>B</p>  <p>2pcs</p>	<p>C</p>  <p>1pc</p>	<p>D</p>  <p>3pcs</p>	<p>E</p>  <p>3pcs</p>	<p>F</p>  <p>1pc</p>
<p>G</p>  <p>2pcs</p>	<p>H</p>  <p>3pcs</p>	<p>I</p>  <p>3pcs</p>	<p>J</p>  <p>4pcs</p>		

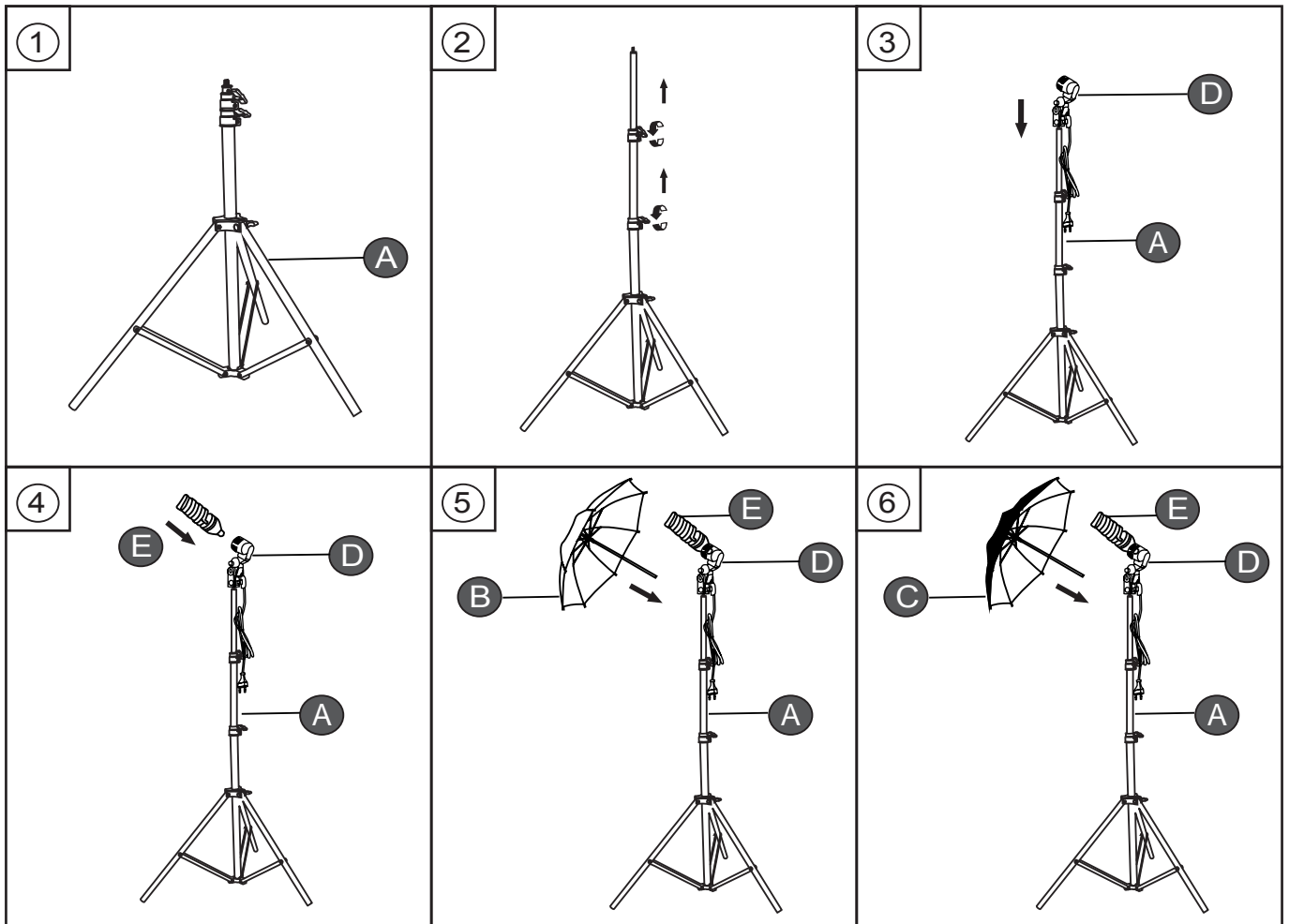

Installation Instruction:

Reflecting umbrella installation steps:

1. Extend the stand to the suitable height
2. Loose the lock and raise the pole
3. Install the light head on the light stand holder
4. Install the bulb on the lamp holder
5. Place the umbrella between the lamp holders

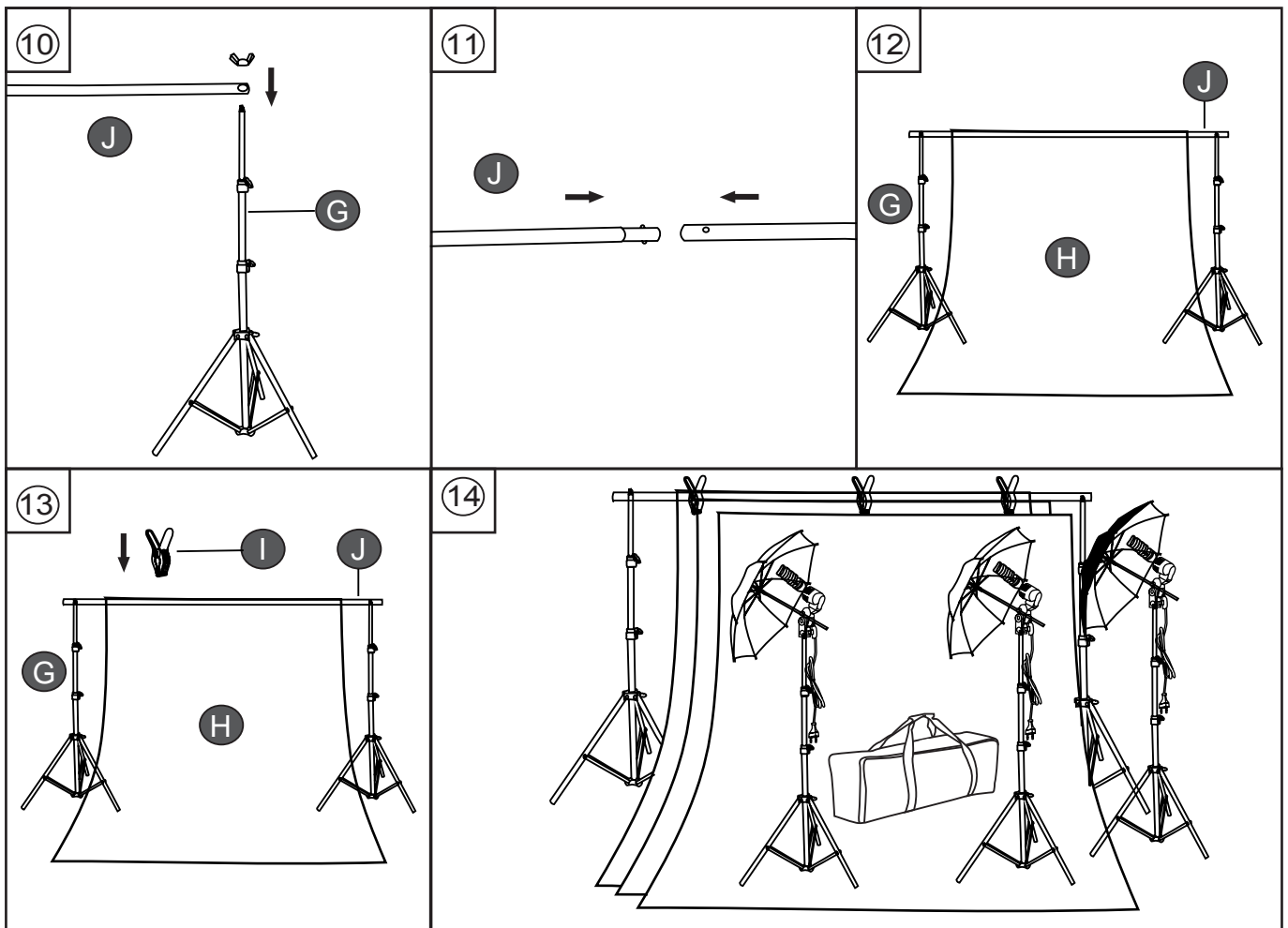

2X3m background installation steps:

1. Extend the stand to the suitable height
2. Loose the lock and raise the pole
3. Loose the second lock and raise the pole
4. Press the button and align orientation, then connect each other
5. Unscrew the knob of the stand, put the pole with holes to the top of the stand
6. Fasten the knob
7. Use clamp to fix the backdrop at the cross bar

PRODUCT LIST:



3* 2m light stand



1* 33inch black golden umbrella



2* 33inch white umbrella



3* single light head
(1.8m US standard electric wire)



3* 45W bulb



3* clamps (black)



1* 2X3m background
(4 cross)



3* 1.6X3m fabric backdrop
(black, white, green)



1* carry bag

Installation Instruction:

Reflecting umbrella installation steps:



1. Extend the stand to the suitable height



2. Loose the lock and raise the pole height



3. Install the light head on the light stand holder



4. Install the bulb on the lamp holder



5. Place the umbrella between the lamp holders



6. Finish

Installation Instruction:

2X3m background installation steps:



1. Extend the stand to the suitable height



2. Loose the lock and raise the pole height



3. Loose the second lock and raise the pole

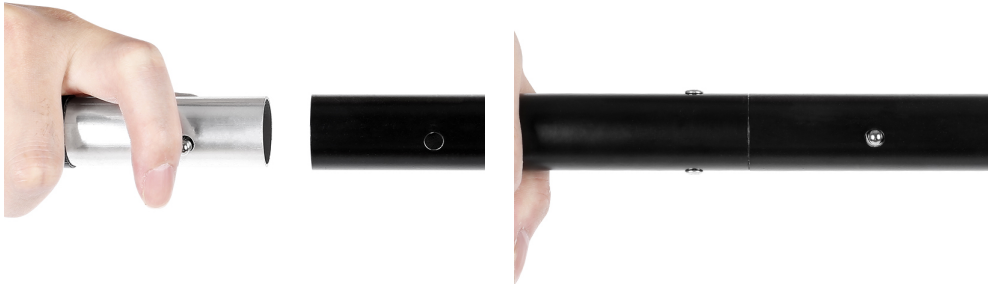

4. Press the button and align orientation, then connect each other



5. Unscrew the knob of the stand



6. put the pole with holes to the top of the stand



7. Fasten the knob

Installation Instruction:

2X3m backdrop installation steps:



8. Use clamp to fix the backdrop at the cross bar



9. Finish