

Sectional - Fabric

ASSEMBLY INSTRUCTIONS

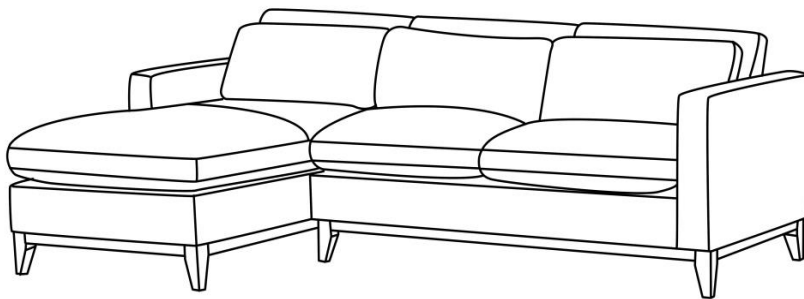

IMPORTANT SAFETY INSTRUCTIONS:

- Read all instructions carefully before unpacking assembly parts. Sharp, exposed staple tips can cause injury. For your protection, please remove any exposed staples used in packing.
- For your safety, assembly by two or more adults is recommended.
- Use only vendor supplied hardware to assemble. Using unauthorized hardware could jeopardize the structural integrity of the item.
- Keep instructions for future use.
- Intended for residential use only.
- Keep small parts and hardware out of the reach of children.







PRE-ASSEMBLY INSTRUCTIONS:

- Remove all parts and hardware from the box and place them on a carpeted or scratch-free work surface.
- To avoid accidentally discarding small parts or hardware, please do not dispose of any contents until assembly is complete.
- Prior to starting assembly, use the parts and hardware lists to identify and separate each of the pieces included.
- Do not over-tighten screws or bolts.

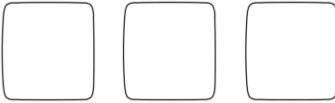
TABLE OF CONTENTS

Parts List	Page 3
Assembly Instructions	Pages 4-7
Care & Maintenance & Warnings	Pages 8

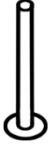
PARTS LIST

PART #	PICTURE	PART DESCRIPTION	INTERNAL #	LOCATION	QTY
A 1		Lumbar Cushion (1pc cushion for LAF Chaise,2pcs cushion for Loveseat)	N/A	Directly in the carton	3
A 2		Back Cushion (1 cushion for LAF Chaise,2 cushion for Loveseat)	N/A	Directly in the carton	3
B		Seat Base (1 seat base in each box)	N/A	Directly in the carton	2
C		Wood Legs (4pcs in each box,8pcs for a whole set of sectional)	MJ-01-241	Seat Back	8
D		Washer (M8* \varnothing 19mm) 4pcs in each box,8pcs for a whole set of sectional	W-M8*19	Seat Back -with legs together	8
E		Screw (M8*60mm) 4pcs in each box,8pcs for a whole set of sectional	S-M8*60	Seat Back -with legs together	8
F		Wrench (1 wrench in each box,2pcs for a whole set of sectional)	W-M8*150	Seat Back -with legs together	2
G		Middle Leg (1pc leg for LAF Chaise,1pc leg for Loveseat)	P-50*H120	Seat Back	2

Thank you for your purchase. Be sure to check all packing material carefully for small parts which may have come loose inside the carton during shipment. Identify and count all parts and compare with the parts and hardware lists.

STEPS

Step 1: Take down the legs from the seat cushion, and assemble them into the holes under the seat base.

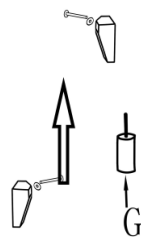
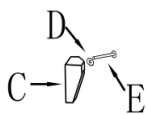
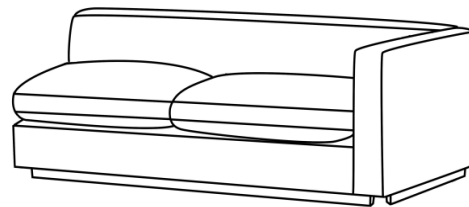
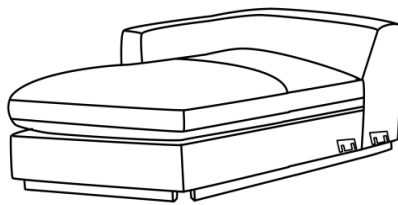
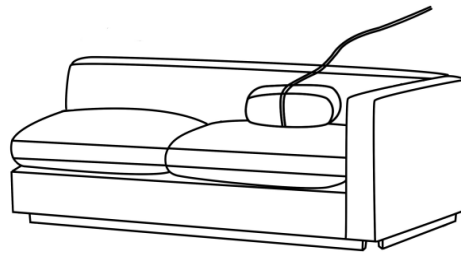
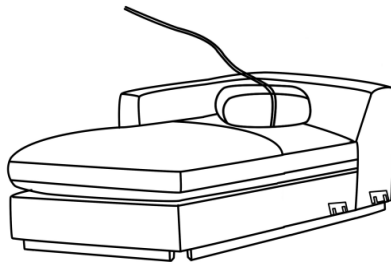

STEPS

Turn down the LAF Chaise on arm side, install the wood legs "C" and plastic leg "G" into the wood frames, like the line drawings shows as below

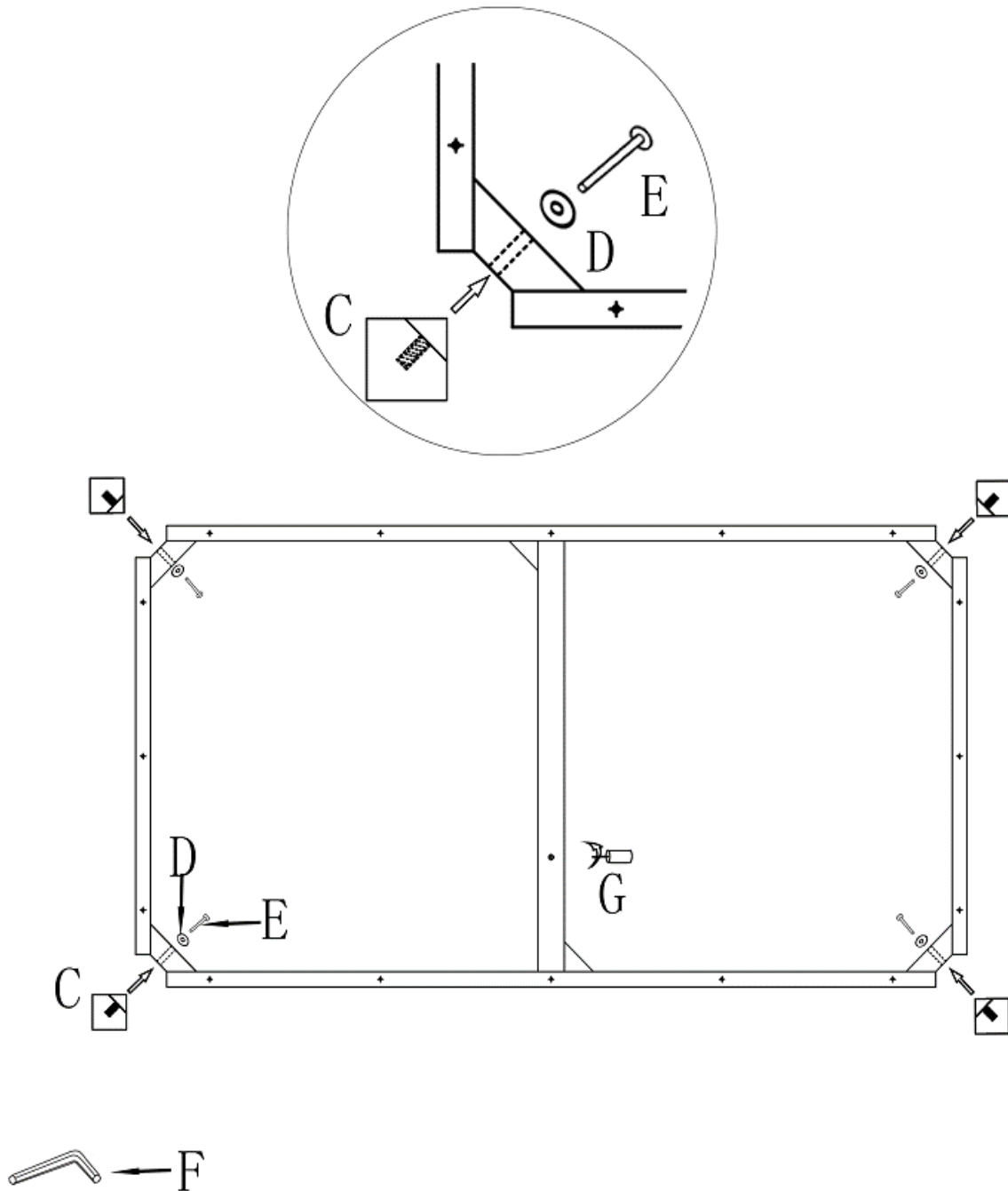

STEPS

Turn down the RAF Loveseat on arm side, install the wood legs "C" and plastic leg "G" into the wood frames, like the line drawings shows as below

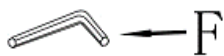
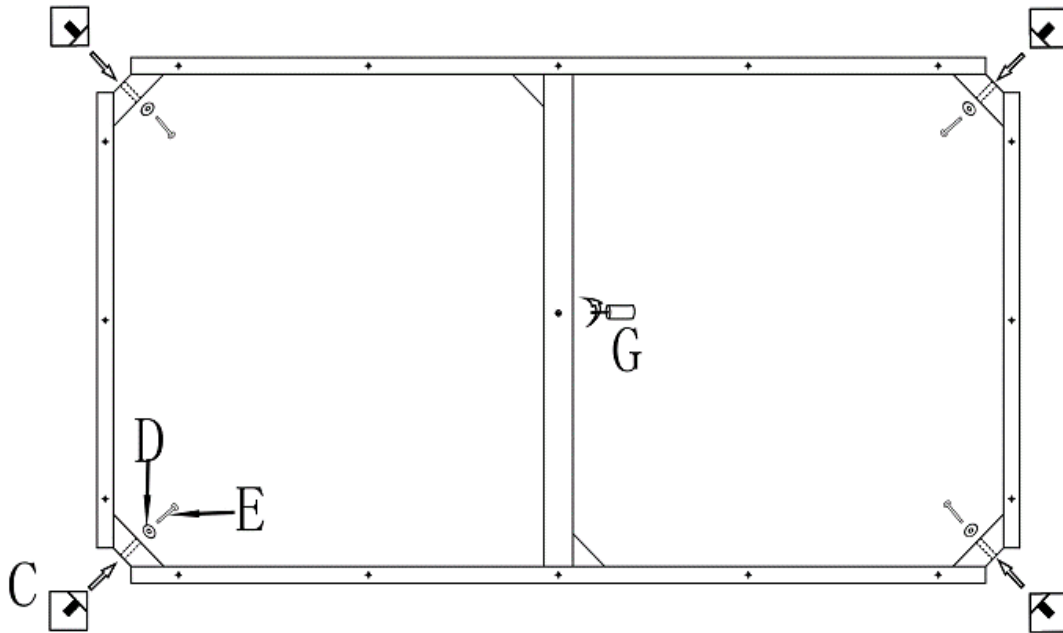
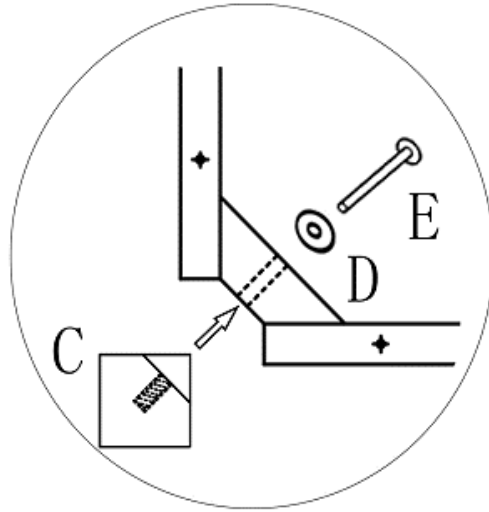

STEPS

Step 2: Attach the back cushion A2 to the back of the product with pre-attached velcro.

Step 3: Put the lumbar cushion A1 on the seat cushion. Close to the A2.

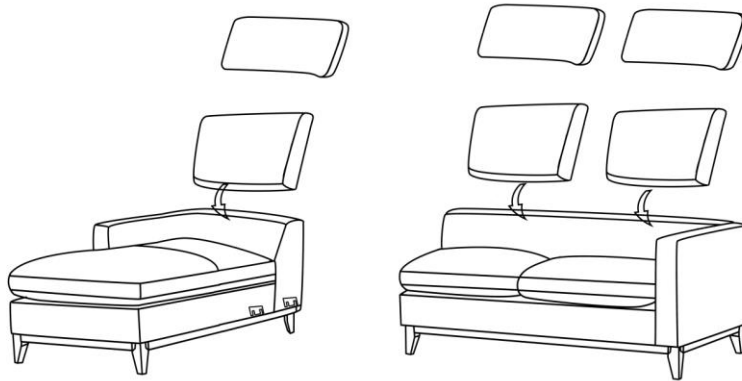

STEPS

Step 4: Connect the sectional together by locking the metal plates in the side of sectionals into place.

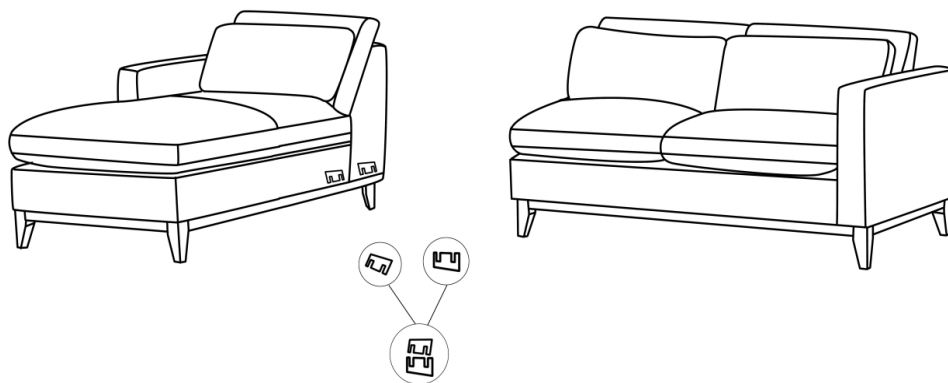



CARE & MAINTENANCE



Leather Care Tips

- Fabric can fade when exposed to direct sunlight over a long period of time.
- To minimize fading, avoid placing your furniture in direct sunlight.
- Avoid cleaners which use chemical products. Many of these are harsh and not safe for use on upholstery.
- Stress to the fabric may result in tears and when stretched, upholstery may not completely return to its original shape.
- Avoid sitting in one area and use the seating areas evenly for even wear.
- Leather and fabric are not resistant to animals. Allowing pets on your upholstered furniture is not recommended.
- If pillow cushions are sewn to the frame, any pulling or tugging may result in a tear.



WARNING



- Do not use this product unless all screws and bolts are securely tightened.
- Check that all screws and bolts are secure every three months or as needed
- Dispose of packing material properly. Do not use plastic cover as head covering as it may cause suffocation.
- Do not use this product as a stepladder.
- Use this product for intended purpose only.
- Intended for residential use only.