

CARE AND MAINTENANCE









Spot clean using a mild water-free solvent. Only a professional cleaner should undertake a complete overall cleaning.

The use of steam or water-based cleaners may cause excessive shrinking or staining.

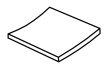
NOTICE

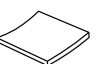
- * Prior to assembly, ensure that all parts are accounted for.
- * This item should be assembled on a soft surface to prevent scratching the finish during assembly.
- * This item may require periodic tightening.
- * Do not overtighten bolts.

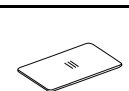
Part List And Hardware List

PIECE	DESCRIPTION	PICTURE	QUANTITY	Carton Call
A	Chair		3	1 of 3
B	Chair leg		3	1 of 3
C	Cushion		3	1 of 3
A	Chair		3	2 of 3
B	Chair leg		3	2 of 3
C	Cushion		3	2 of 3
D	Table Top		1	3 of 3
E	Table Leg		4	3 of 3
F	Table Glass		1	3 of 3
HW1	Bolt and washer	 M6*15	64	3 of 3
HW2	Allen Key		2	3 of 3

Item Dimension
 Chair: 22.4"x24.2"x34.1"
 Table: 59.1"x35.6"x29.1"
 Item Weight Capacities
 1SEATER:220LBS
 TABLE:110LBS

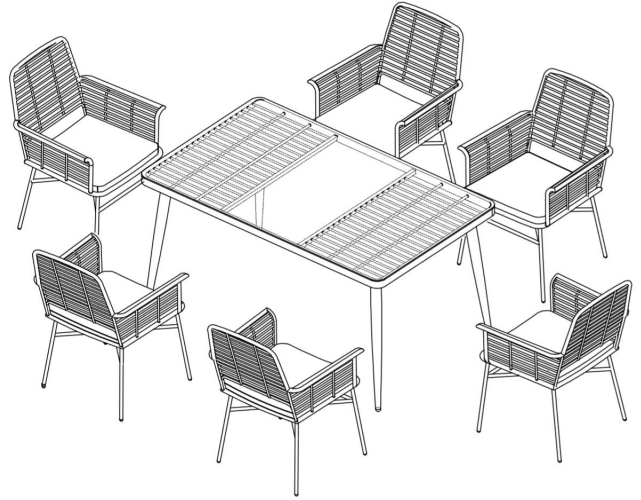

PREPARATION

Before beginning assembly of product, make sure all parts are present. Compare parts with package contents list and hardware contents list. If any part is missing or damaged, do not attempt to assemble the product.

Estimated Assembly Time: 45 minutes.

Tools Required for Assembly (included): Allen Key

Chair Assemble

STEP 1

Gradually tighten bolts in a star pattern: tighten one bolt and then the one opposite from it until all bolts are tightened.

1. Assemble the chair leg (B) to the chair (A), using bolt and washer (HW1).

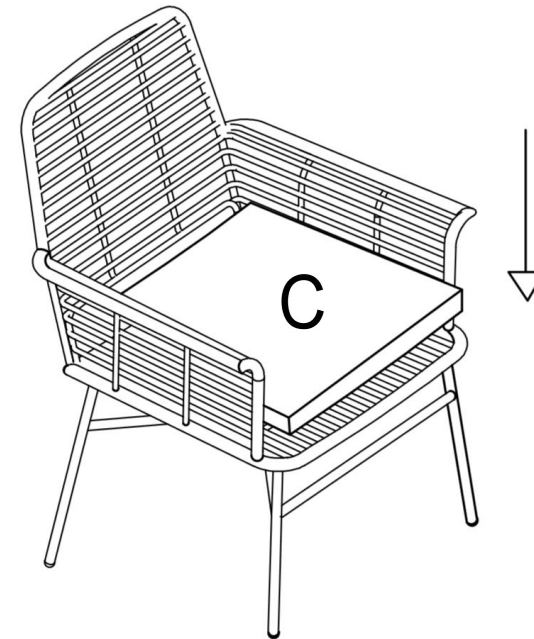
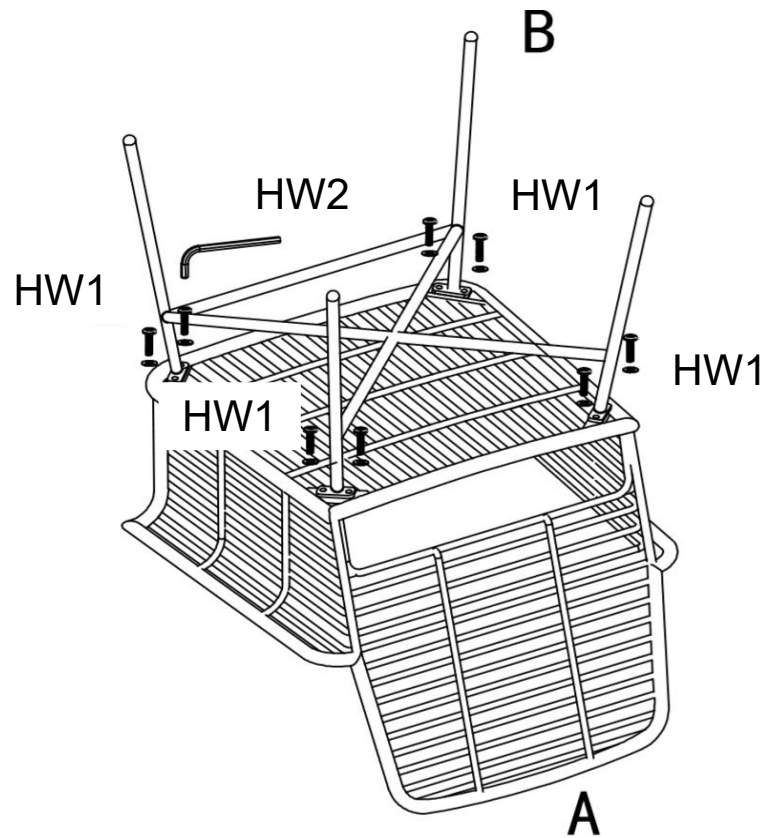

PREPARATION

Before beginning assembly of product, make sure all parts are present. Compare parts with package contents list and hardware contents list. If any part is missing or damaged, do not attempt to assemble the product.

Estimated Assembly Time: 45 minutes.

Tools Required for Assembly (included): Allen Key

Table Assemble

Gradually tighten bolts in a star pattern: tighten one bolt and then the one opposite from it until all bolts are tightened.

2. Assemble the table leg (E) to the table top (D), using bolt and washer (HW1).

3. Put the glass on the top.

STEP 2

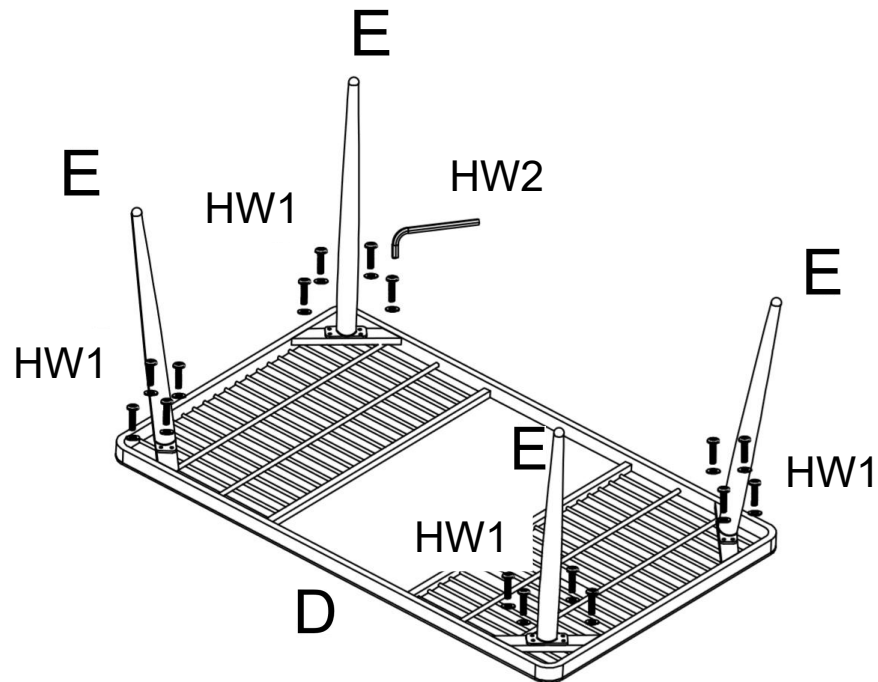

STEP 3

