



STOP

We just wanted to thank you for allowing New Ridge Home to be a part of your home. If you love what you received, please take the time to write a review on the site you purchased from.

WAIT

If there is any issue with your purchase, please contact us using the information found below. In many cases we have a part or hardware that will fix the issue without the hassle of having to return the item. To make a parts request, please note the following in your e-mail:

SKU number on the box (starting with NR)

The part number or letter of the part on the instruction sheet

A brief description of the issue

Your name & address

If possible, please also include a picture of the issue or the product.

Send request to: kcovey@newridgehomegoods.com

HOLD ON

Don't forget to check out our website www.newridgehomegoods.com where you will find our complete line of products, assembly instructions, and more.

From our entire team, Thank You for your business, we truly appreciate it!



ASSEMBLY INSTRUCTIONS





SWIVEL BARSTOOL

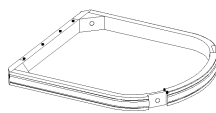



Do not fully tighten all screws until assembly is complete.

NR105553-FBS-AW NR105554-FCS-AW

A SEAT  1 PC	B STRETCHER  1 PC	C FRONT LEG  2 PC	D BACK LEG  2 PC
---	--	--	---

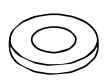
1 LONG BOLT 5/16" x 13 x 2-1/2"  10 PC	2 SPRING WASHER 5/16" x 12D x 1.5mm  10 PC	3 FLAT WASHER 5/16" x 12D x 1.5mm  10 PC	4 SHORT BOLT 1/4" x 12 x 1-4/7"  2PC
--	--	---	--

5 SPRING WASHER 1/4" x 10D x 1.5mm  2PC	6 FLAT WASHER 1/4" x 10D x 1.5mm  2PC	7 ALLEN KEY 2-1/4" x 4mm  1 PC
---	---	---

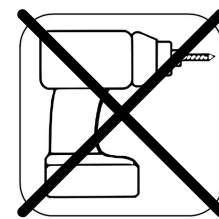
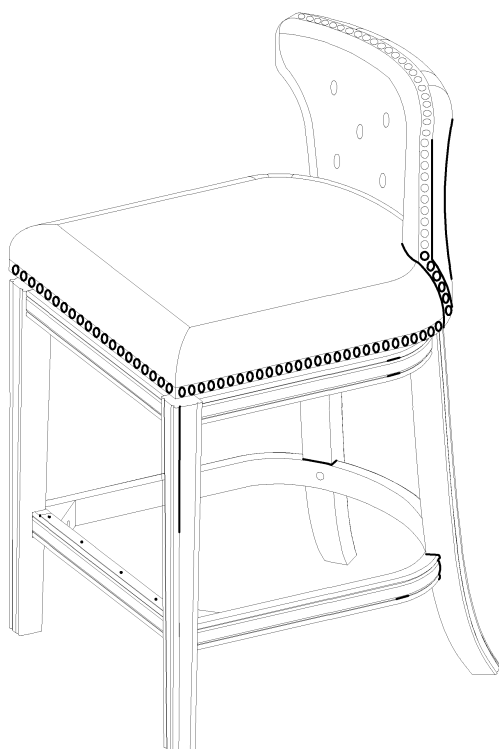

**No drills necessary.
Do not use power
screwdriver.**

This page lists all the contents included in the box. Please take the time to identify the hardware as well as the individual components to this product. As you unpack and prepare for assembly, place the contents on a carpeted or padded area to protect them from damage.

STEP 1 Attach one front leg (C) and 2 back legs (D) to the seat (A) with bolts (1), spring washers (2), and flat washers (3) using Allen key (7).

Do not fully tighten the bolts. Leave the legs loosely attached for now. This will allow for easier assembly of the stretcher.

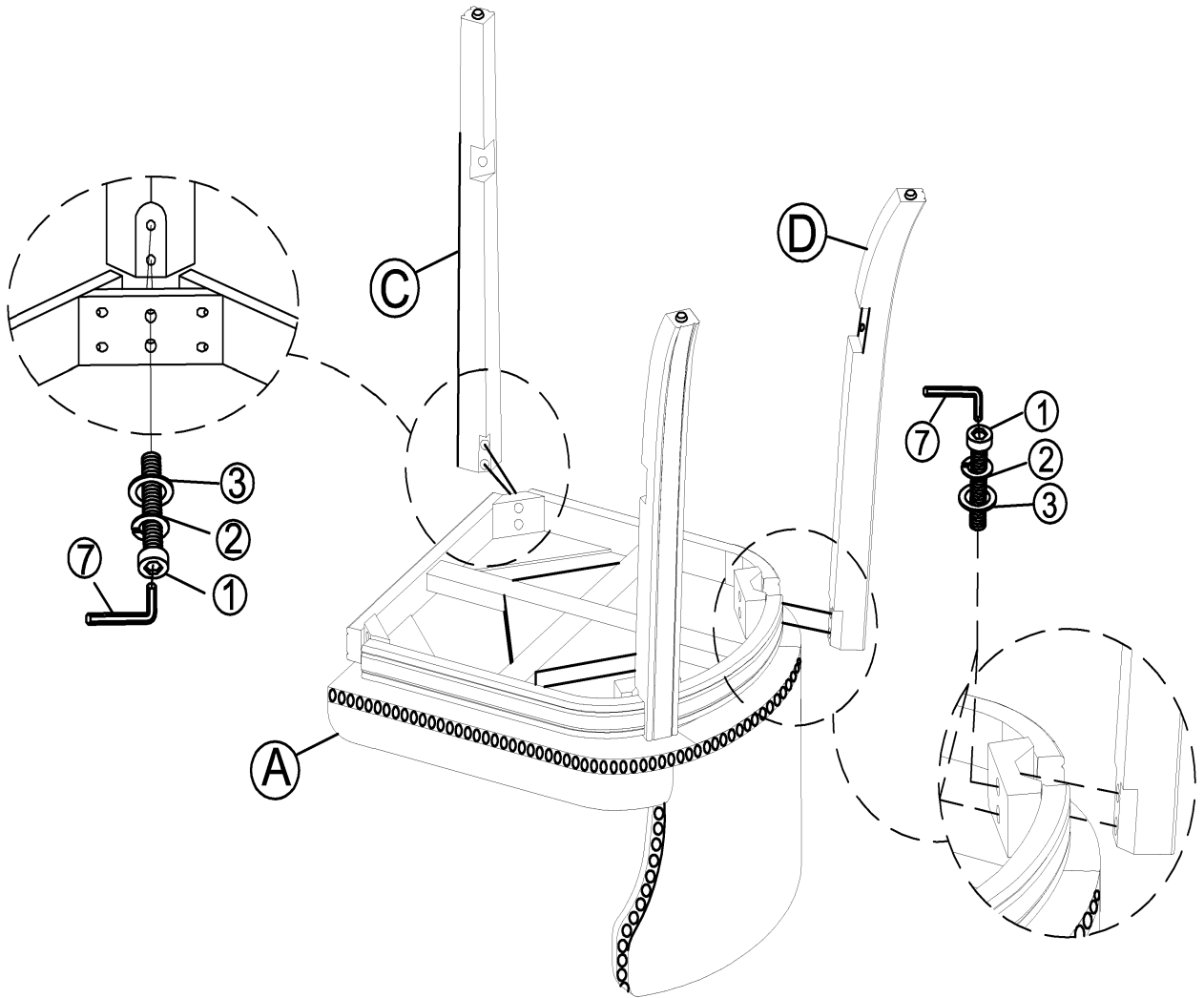

STEP 2

Insert stretcher (D) into the joint of legs (C) and (D).
Make sure the metal foot rest on the stretcher is facing towards the seat and is pointing towards the front of the stool.

Attach the stretcher (D) to the front leg (C) from step 1 with long bolts (1), spring washers (2), and flat washers (3) using Allen key (7). Do not fully tighten the bolts.

Attach the stretcher (D) to the back legs (D) from step 1 with short bolts (4), spring washers (5), and flat washers (6) using Allen key (7). Please note the different length of the bolts!

Do not fully tighten the bolts.

Attach another front leg (C) to the stretcher and the seat with long bolts (1), spring washers (2), and flat washers (3) using Allen key (7). Do not fully tighten the bolts.

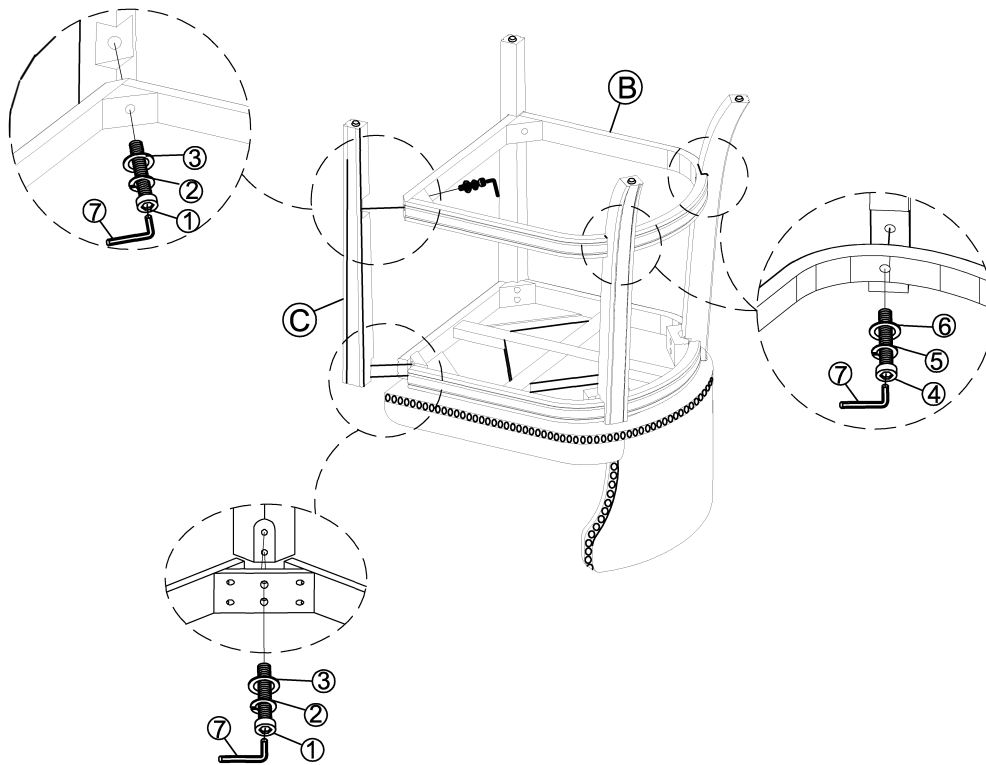

STEP 3

Turn stool upright and place on flat surface. Ensure the legs are aligned and seat is level, then fully tighten all bolts from Steps 1 and 2.

COMPLETE

