

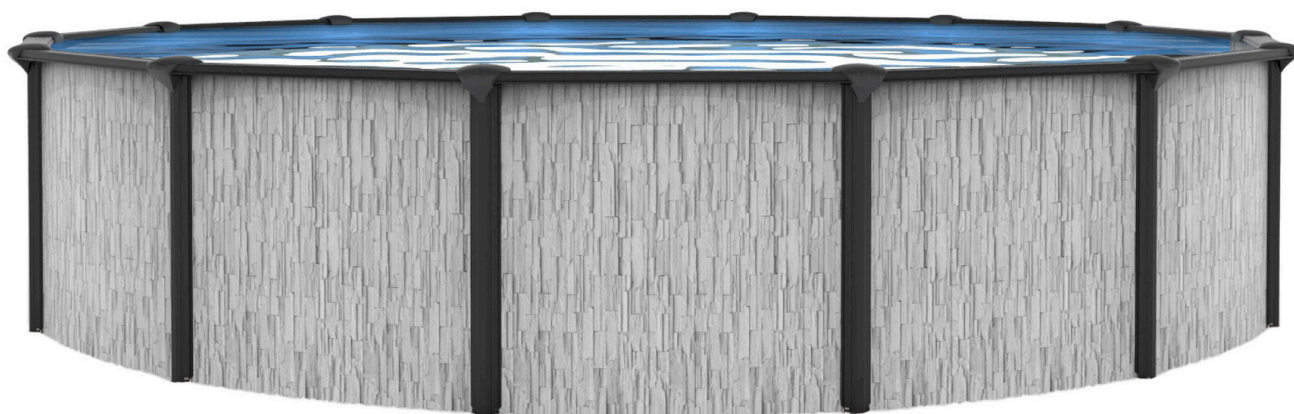

SKU# NB9869

SEVILLA 24-FT ROUND 52-IN DEEP STEEL WALL POOL

INSTRUCTION MANUAL



Questions, problems, missing parts?

Contact Blue Wave Customer Service at 1-800-759-0977, Monday – Friday.
8am – 5pm (CST)

THANK YOU!

Thank you for purchasing this product. We work around the clock and around the globe to ensure that our products maintain the highest possible quality. However, in the rare case of issues during assembly or use of this product, please contact **Blue Wave Customer Service at 1-800-759-0977** for immediate assistance before contacting your retailer. Please read the warranty information at the back of these assembly instructions for further details.



SAVE THIS INSTRUCTION MANUAL

Use of unauthorized replacement parts voids the warranty.

ATTENTION INSTALLER! THIS MANUAL CONTAINS IMPORTANT INFORMATION ABOUT THE INSTALLATION, OPERATION, AND SAFE USE OF THIS POOL AND MUST BE FURNISHED TO THE END USER OF THIS PRODUCT. FAILURE TO READ AND FOLLOW ALL INSTRUCTIONS COULD RESULT IN SERIOUS INJURY.

SAFETY INSTRUCTIONS

WARNING: Children have drowned in swimming pools.

WARNING: Ensure active adult supervision at all times. Do not leave children unsupervised in or around the pool. Keep them within arms reach.

WARNING: Consult local municipality, water authority, and building codes in regard to the use of water and/or water restrictions relating to this product.

WARNING: Pool fencing laws affect this product, consult the local municipality for applicable building codes. Abide by state and federal law requirements such as fencing, enclosures, childproof gates, etc.

WARNING: Always remove pool ladder when not in use. Store in a place where it is not accessible to children.

DANGER: Prevent the risk of accidental drowning. Extreme caution must be exercised to prevent unsupervised access by children. To avoid accidents, ensure that children cannot use the pool unless they are always supervised by an adult. NEVER LEAVE CHILDREN UNATTENDED.

RISK OF ELECTRIC SHOCK: Connect the filter pump only to a grounding type receptacle protected by a GFCI (Ground Fault Circuit Interrupter). Use a qualified electrician to install the GFCI, which has a maximum rate of 30A.

WARNING: Always know where the cut-off switch for the pump is, so it can be turned off in an emergency. It is necessary to have the GFCI Cut-Off Switch plug accessible after installation of the pool.

WARNING: To avoid electrocution, do not permit electric devices i.e., electric lights, telephone, radio, television, hair dryer, etc. within 8-ft of this pool.

WARNING: Do not touch the filter pump unless the area around it is completely dry.

WARNING: NEVER allow horseplay, diving, or jumping into or around the pool.

WARNING: NEVER jump into the pool via any decks or other raised surface, the water level of the pool is shallow. Serious injury, paralysis, or death could result.

CAUTION: It is advisable to wear protective gloves when assembling pool.

WARNING: Follow all safety and installation instructions provided with the filtration system, ladder, and accessories



GENERAL WATER SAFETY

- ALWAYS supervise children around water.
- Ensure a pool fence is correctly installed and functioning if it is required by your local municipality or state code.
- Follow all local and National Pool Safety Codes.
- Learn CPR and keep in practice.
- Post emergency phone numbers near a phone and the pool.
- Teach your children to swim as early as possible.
- Keep any object that could be used by a child to climb into the pool at least 4-ft away from the side of the pool.
- Read these safety instructions to your children often.
- Prepare yourself mentally for any situation that may occur. You may be required to offer adequate aid and assistance.
- Many swimming pool and water safety publications are available online. You are urged to review them and share with all members of your family.

GENERAL WATER SAFETY (CONTINUED)

- Name only one safety supervisor when people are in the pool.
- Reinforce supervision when there are several users in the swimming pool. Have personal flotation aids available (for people who cannot swim).
- Wet your neck, arms, and legs before you enter the water.
- Do not allow children who are unable to swim to enter the pool without swim vest or approved life jacket, and without adult supervision. Flotation devices are not a substitute for adult supervision.
- Do not leave toys near or in the pool without supervision.
- Always keep the water clear and sanitized.
- Store the water treatment products away from children's reach.
- Do not leave children alone when you are talking on or looking at your phone.
- Always keep a pool buoy and pool pole at the pool side.
- Keep the pool fence gate shut when the pool is not occupied.
- If possible, use an electronic pool alarm that can detect someone falling into a pool.
- Install all warning and danger decals and signs as instructed.
- Contact the dealer or retailer for additional signs if deemed necessary.

THERE IS NO REPLACEMENT FOR CLOSE ADULT SUPERVISION OF CHILDREN

SAVE THESE INSTRUCTIONS

PARTS LIST

NB9869

See page 4 for schematic.

REF. #	PART #	MFG. #	DESCRIPTION	QTY.
WALL CARTON (PC6447)				
4	-	-	24-FT Sevilla Wall	1
3	NBP1019	8100	Plastic Coping Strips	18
NBP1021 - 0113 Wall Bolt Hardware Pack contains:				
10	-	0411	1/4-IN Reinforcing Washer	51
10	-	0513	1/4 x 1/2-IN Truss Head Screw	26
10	-	0611	1/4-IN Hex Nut	26
RAIL CARTON (PC5054, 24-5/8RAIL-2)				
2	NBP1057	1624	5/8-IN Top and Bottom Rail	32
FRAME CARTON #1 (PC6419, 2452-6H-DG-2)				
1	NBP6257	1164DG	6-IN Top Seat	16
8	NBP6258	2366DG	5-IN Vertical	16
FRAME CARTON #2 (PC6420, 24-AQL-DG-3)				
5	NBP6259	2465DG	Inside Seat Cover	16
7	NBP6260	2466DG	Outside Seat Cover	16
6	NBP1068	2168	6-IN Resin Top Joint	16
9	NBP1069	2268	6-IN Resin Bottom Joint	16
NBP6263 - 0119-02-24 Hardware Pack contains:				
11	NBP1203	0341	#12 Sheet Metal Screw	192
SKIMMER CARTON (NA324ASM)				
12	NA324ASM	NA324	Widemouth Skimmer and Return	1

ADDITIONAL EQUIPMENT REQUIRED:

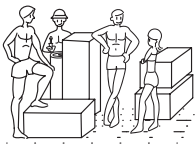

Friends



Screwdriver

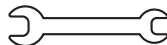

Wrench



Spray Paint



Roller



Level



Knife



Duct Tape



Measuring Tape



8-IN Nail



Mason Sand

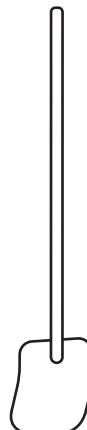

Shovel



Rake

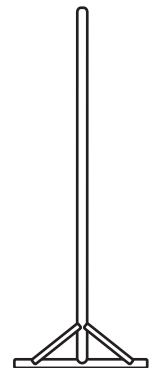

Tamping Tool

PARTS LIST (NOT TO SCALE)

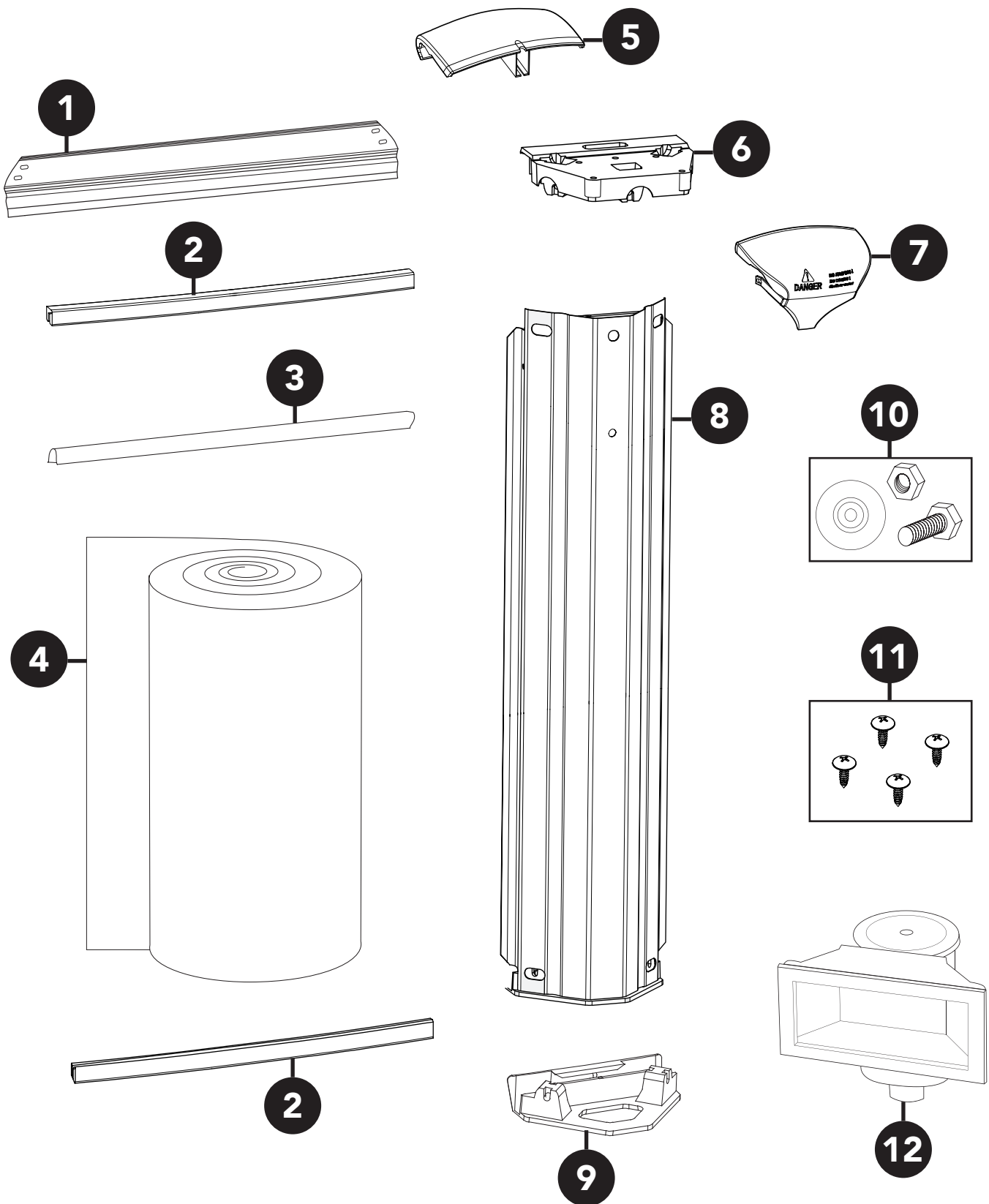

GENERAL INFORMATION

Before attempting to set up the pool, read the entire instructions. There are certain areas in the instructions that are extremely important to follow exactly as written and/or pictured. Any deviation from these instructions voids warranty of the pool and could cause bodily harm or damage to your property.

Open the cartons and remove all parts except steel wall and liner. Before pool assembly, you must identify, count and check all parts for assembly by parts list. Familiarize yourself with all of the parts. Refer to the parts list.

NOTE

Do not start the installation of your pool unless you have an entire day to finish the work. Do not try to set up your pool on a windy day. The wall will be difficult or even impossible to handle.

POOL SIZE	POOL PERIMETER	# OF UPRIGHTS	# OF PATIO BLOCKS	AMOUNT OF SAND NEEDED	# OF WALL FOAM ROLLS NEEDED*	# SPRAY ADHESIVE CANS NEEDED*	# OF POOL COVES NEEDED*
12-FT	13-FT	10	10	19.97 YD ³	1 - 60-FT ROLL	2	12
15-FT	16-FT	10	10	31.20 YD ³	1 - 60-FT ROLL	2	12
18-FT	19-FT	12	12	44.92 YD ³	1 - 60-FT ROLL	2	14
21-FT	22-FT	14	14	61.15 YD ³	1 - 75-FT ROLL	3	17
24-FT	25-FT	16	16	79.87 YD ³	1 - 85-FT ROLL	4	19
27-FT	28-FT	18	18	101.08 YD ³	1 - 100-FT ROLL	4	22
30-FT	31-FT	20	20	124.79 YD ³	1 - 100-FT ROLL	4	24
33-FT	34-FT	22	22	151 YD ³	2 - 60-FT ROLLS	4	26

* See page 14 for buying options

CHOOSING A LOCATION

1. When choosing a site, the area around the pool must be large enough to accommodate patio furniture and other pool accessories.
2. Determine where your filtration and skimmer will be located. It must be connected to a grounded 110 volt electrical outlet, with a G.F.I. (Ground Fault Interrupter).
3. The pool must be in reach of your water supply. Although the water should not be drained, but kept clean through filtration and chemicals, there should be drainage facilities near in case of need.
4. The perimeter of the pool area must be level and firm. All grass and sod under the entire pool area must be dug out to avoid unpleasant odors from decomposition due to lack of air. If the ground has been treated with chemicals or weed killer allow two weeks before setting up the pool.
5. Remove sharp objects, stones, twigs, pebbles, roots, etc. as they may damage the liner. Do not set up the pool on concrete, asphalt, tar paper, peat moss, coarse sand, gravel, or where nut grass has been planted. Liner is not warranted against this.

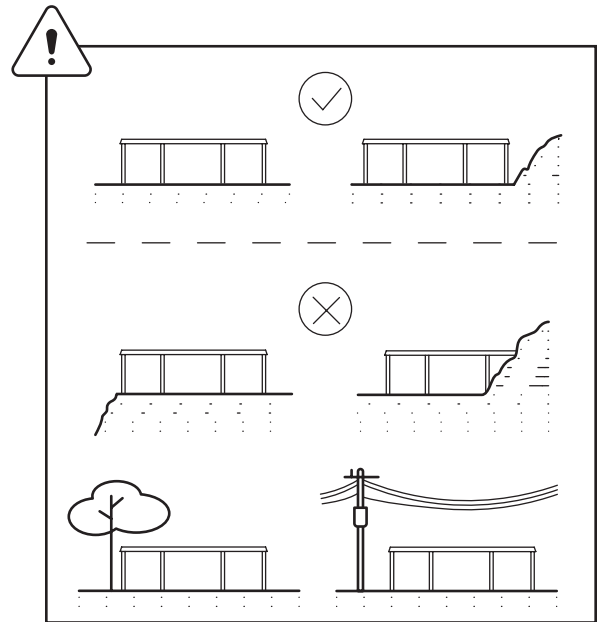
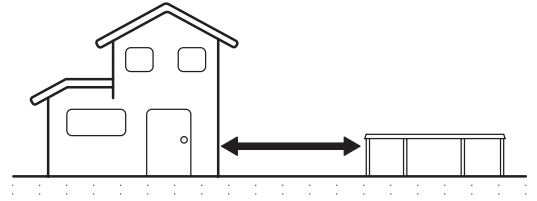

PREPARING THE POOL SITE

1. Determine the circumference of the pool area by using one 8-IN nail in the center of the desired location. With a friend, have them hold a string or measuring tape and mark the pool perimeter 1-FT beyond the pool dimensions using spray paint. Use 4 lawn stakes to mark equidistant points around the radius of the pool to help determine circumference. These points will be where your verticals sit.
2. Using a shovel, remove all grass and sod from the pool area. Make sure the entire pool area is level, not just to the naked eye, but by using a leveling tool.
3. Remove all high spots in the area, but do not fill in the low spots, as setting may cause your pool to become uneven. The ground below the pool must be firm.

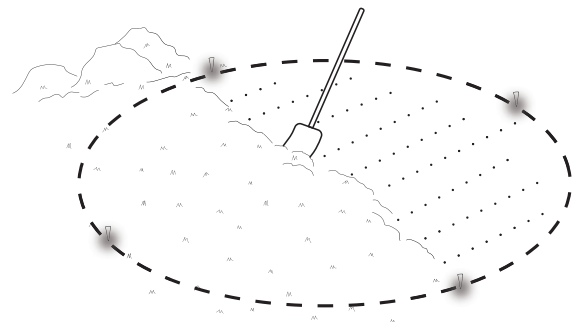
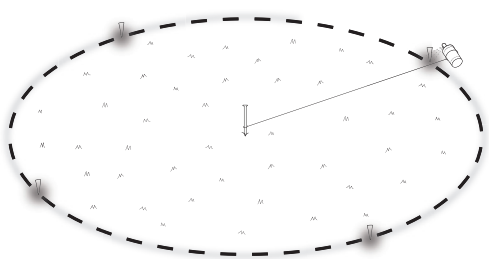

ASSEMBLING THE BOTTOM RAIL

1. Place each curved bottom rail around the circumference of the pool.
2. Place the bottom joints on the marked locations around the pool area. Slide the bottom rail's grooves into the bottom joint to the stop tab.
3. Continue around the entire space until all bottom rails are connected. After the bottom rails are installed, check for levelness from the center nail around the entire area, the distance should be the same from every point.
4. After ensuring the bottom joints are even and level, place 12x12-IN patio blocks under each bottom joint. The top of the blocks must be flush with the ground and centered under each end joint. Mark the space around each patio block and dig out the dirt beneath them, creating an indentation for each block to fit securely. Check that each block is level.
5. Check that all bottom rails are level around the entire pool frame. Remove any debris from the bottom rails.

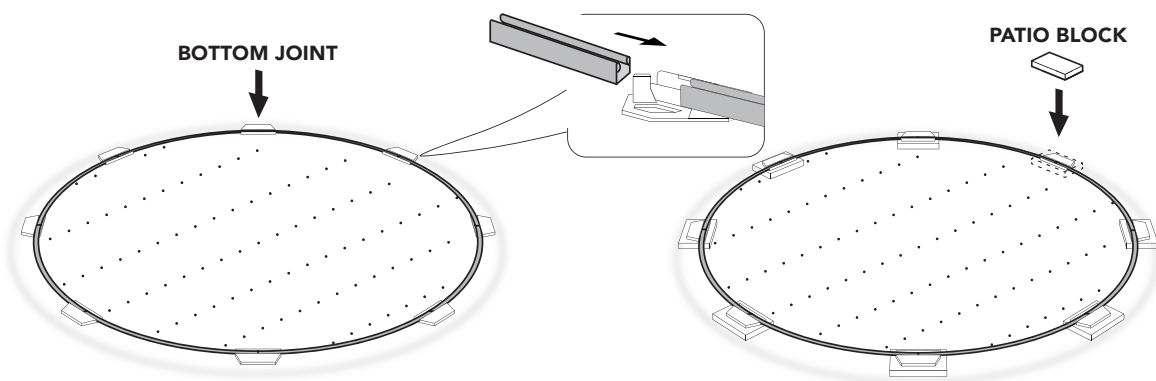

6. Remove one bottom rail from the frame. Use this space to bring in the mason sand or sifted earth. Add a 1 to 2-IN layer of sand and spread it evenly using a rake. When the layer of sand is level, remove the wheelbarrow and replace the bottom rail.

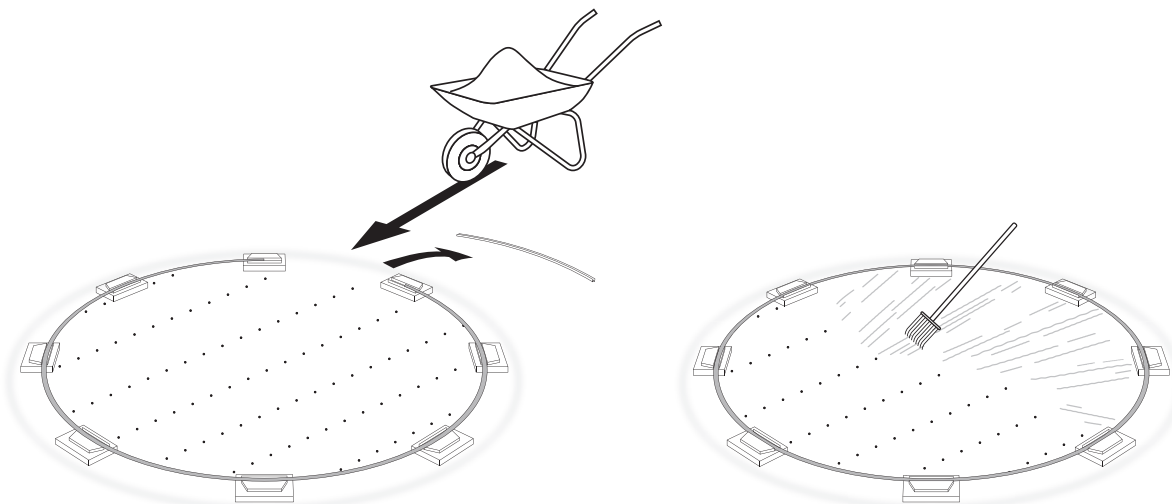

ASSEMBLING THE POOL WALL

1. Place the rolled up pool wall in the center of the pool area. It is recommended to use a piece of plywood under the pool wall as to not disturb the level sand.
2. With one person on the outside of the pool and one person on the inside, start unrolling the pool wall going clockwise. Place the start of the wall in the center of one of the bottom joints on the block closest to where the skimmer and return will be placed.
3. Unroll the wall a little at a time, placing it into the track of the bottom rail as you go. Do not unroll the wall at one time, this will make installation more difficult.
4. While unrolling the wall, place the top rail on top of the wall to temporarily stabilize it.
5. Bring the two ends of the wall together. Secure the walls together by inserting the bolts (hardware pack NBP1021) from the INSIDE of the pool outward. Fasten the bolts from hole to hole all the way down the wall. Do not leave any holes open.
6. When each screw has been fastened, use a strip of duct tape to cover the inside and outside of the bolts. This will protect the pool's liner.
7. Check the levelness of the top of the wall. If it's more than 2-IN off level, rework the ground.

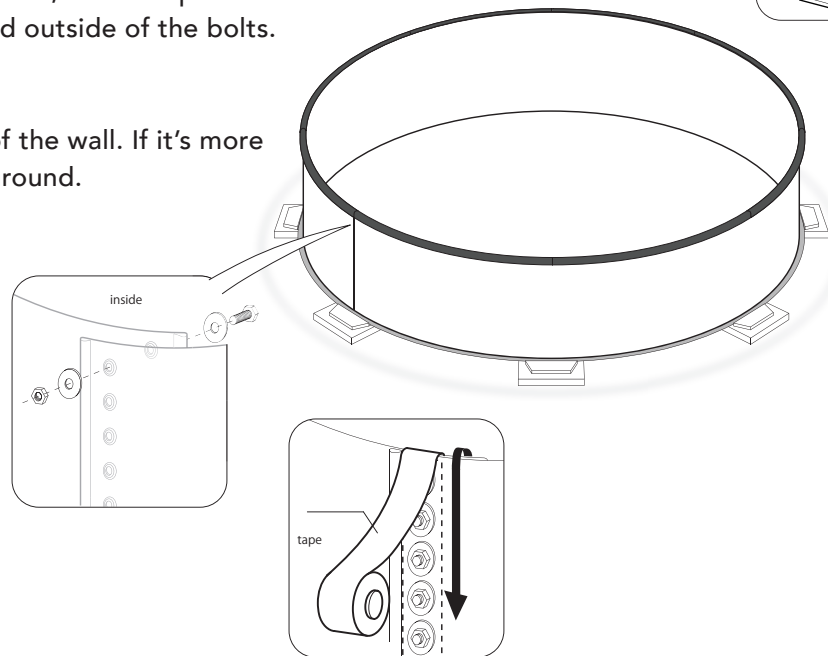
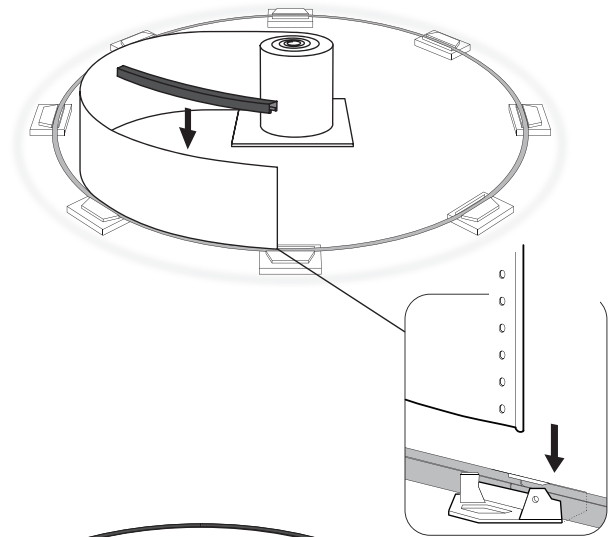
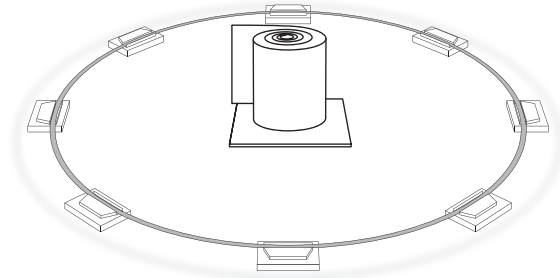

NOTE

Do not fasten the wall without using the reinforcing washers on the inside and outside of the pool. Failure to use reinforcing washers as instructed will cause the wall to split when the pool is filled. This can cause property damage or bodily harm.

BLUE WAVE® WALL FOAM

It is recommended to use wall foam around the interior of the pool to protect the pool liner. Wall foam protects between the pool wall and liner. It also helps to keep the pool insulated. Wall foam and spray adhesive sold separately. See the chart on page 14 for the amount of rolls needed for your pool size.

1. Use the spray adhesive in small sections and press the foam onto the wall. Smooth out any creases and bubbles before installing the liner.

GORILLA PAD®

Gorilla Pad® are another recommended part of the pool assembly. Gorilla Pad® provide cushion to the pool floor and adds mild protection for the liner. Use the chart on page 14 to find the correct size for your pool.

1. Before installing the Gorilla Pad®, be sure to use a roller or tamping tool to even out the sand floor.
2. Unfold the Gorilla Pad® over the leveled sand floor and center it in the pool area.

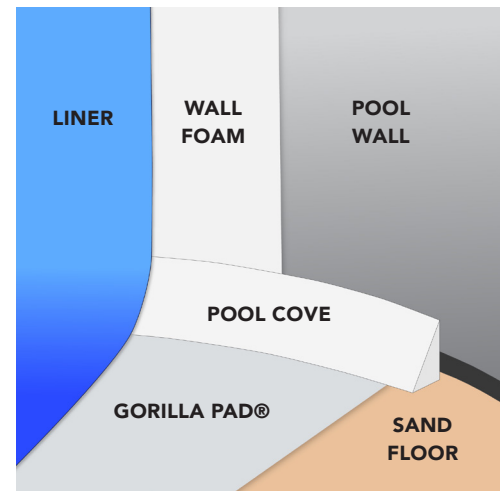

BLUE WAVE® POOL COVE

Creating the pool cove is an essential part of pool installation and must be done properly. Pool coves relieve water pressure from the pool wall, preventing damage done to the liner by pushing it out from under the bottom rail. There are two different types of pool coves, earth mounds and permanent coves. Earth mounds are good for soil or sand that will pack well and are best for areas that don't experience a lot of rainfall. Permanent pool coves, or foam pool coves, are easy to install and won't erode over time from rainfall.

BUILDING A POOL COVE

1. Use a rake or tamping tool to create a mound around the interior of the pool wall. This mound must be 3 to 6-IN high and should extend 8 to 12-IN away from the wall. Pack the sand gently but firmly.

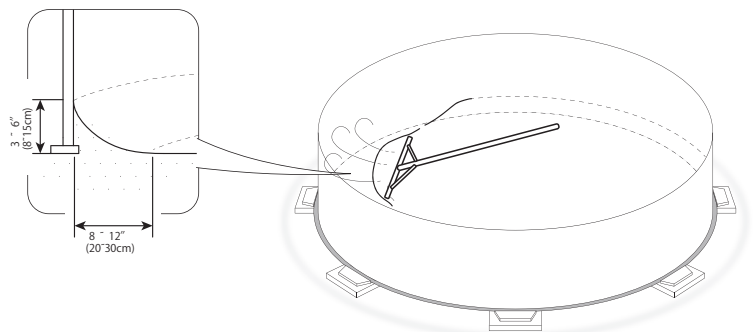

USING BLUE WAVE® PERMANENT COVES

1. Foam pool coves are designed to sit on the bottom rail of the pool. Peel the plastic off of the back of the cove and press firmly into place. Continue around the entire perimeter of the pool.

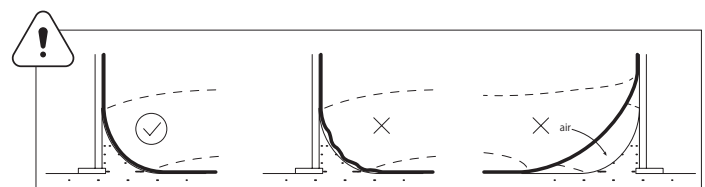

INSTALLING THE LINER

If you did not install a Gorilla Pad®, be sure to use a roller or tamping tool to even out the sand floor. Remove your shoes before installing the liner. Do not forcefully pull on or drag the liner.

1. Carefully open the carton holding the liner by removing the tape, do not cut open the carton with a knife or any sharp object.
2. Unfold the liner inside of the metal wall. Carefully spread it out on the ground with the bottom seam of the liner on the pool cove.
3. Remove the temporarily placed top rails. Drape the edge of the liner over the top of the wall and create a collar approximately 3-IN down the outside of the wall.
4. Place the plastic coping strips (NBP1019) over the liner and slide them into to place inside of the groove of the top joint. Replace the top rails over the plastic coping strips and fasten to the top joint.
5. When the liner is in place, gently push any wrinkles to the pool cove. Be sure to not leave a gap between the liner and the cove.

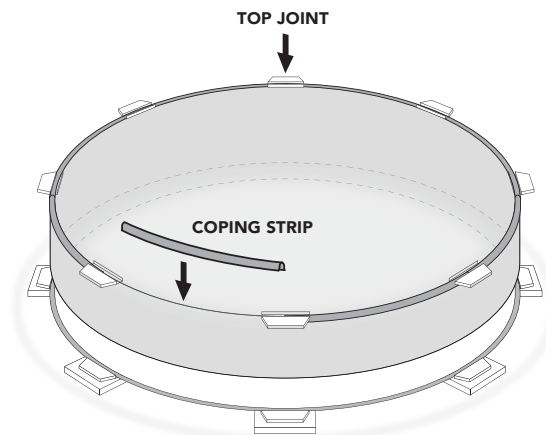
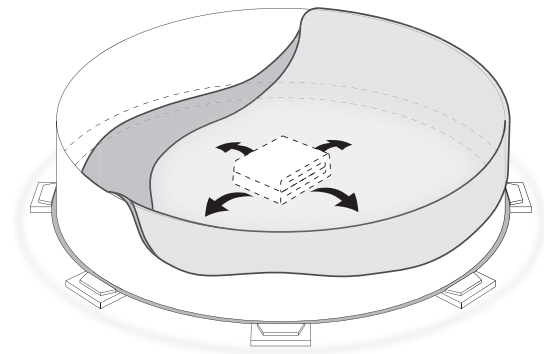
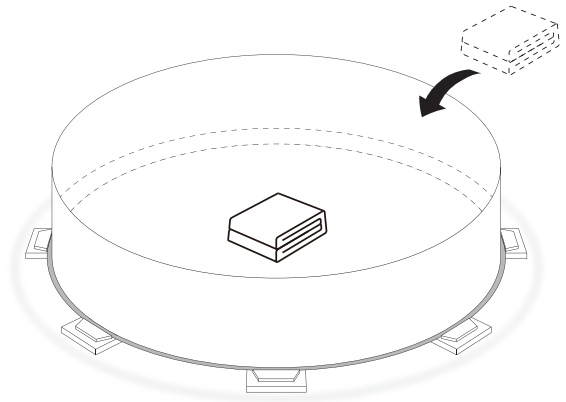

INSTALLING THE VERTICALS

1. Place the vertical over the tabs of the bottom joint and securely fasten them into place with sheet metal screws (NBP1203). Repeat this step for the top joints.

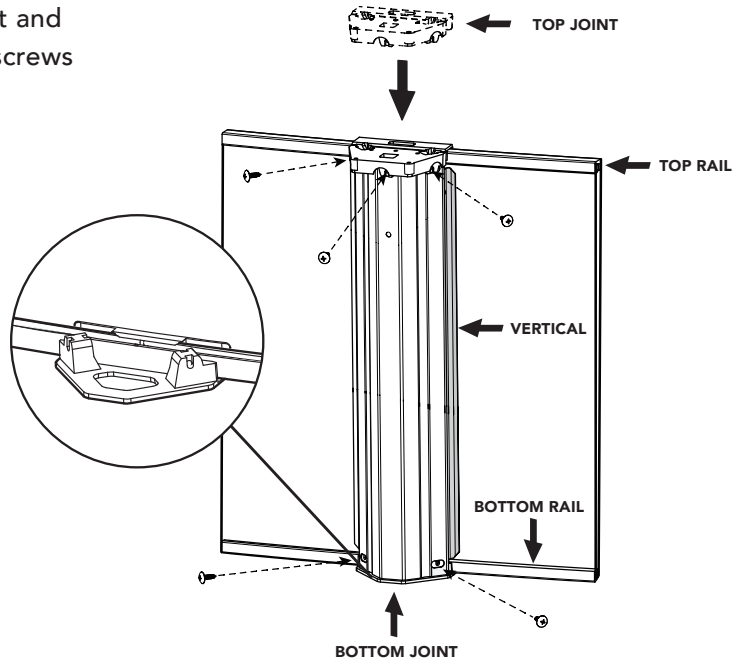

INSTALLING THE TOP SEATS

1. Place the steel top seats over the top joints and secure into place with sheet metal screws (NBP1203).
2. Once all top seats are installed around the pool, connect the inside seat covers to the top joint with sheet metal screws (NBP1203).
3. Connect the outside seat covers to the top joint and securely fasten into place with sheet metal screws (NBP1203).

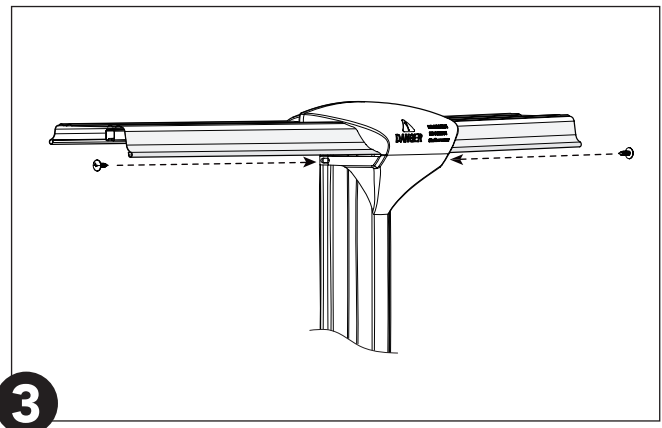
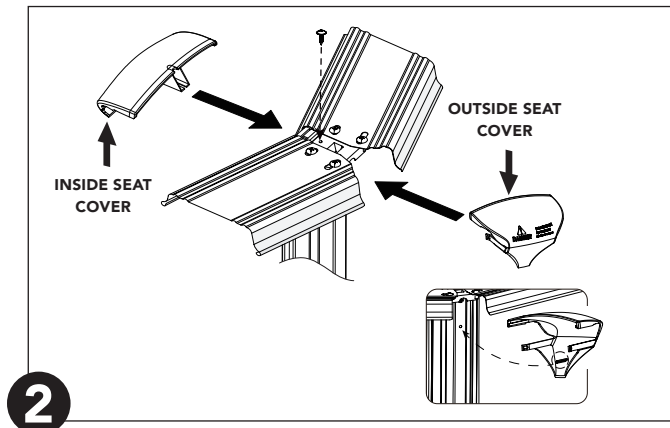
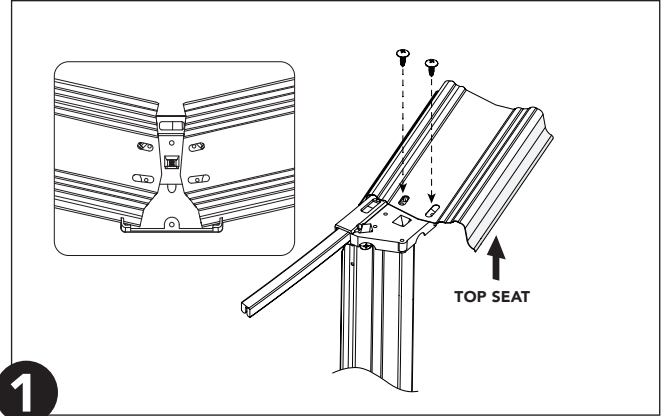

HELPFUL INFORMATION

BLUE WAVE® WALL FOAM AND SPRAY ADHESIVE

SKU	DESCRIPTION	SIZE
NL1970	Blue Wave Above-Ground Closed Cell Wall Foam	60-FT
NL1971	Blue Wave Above-Ground Closed Cell Wall Foam	75-FT
NL1972	Blue Wave Above-Ground Closed Cell Wall Foam	85-FT
NL1973	Blue Wave Above-Ground Closed Cell Wall Foam	100-FT
NL106	Spray Adhesive for Pool Wall Foam	17-OZ

GORILLA PAD® POOL FLOOR LINER PROTECTIVE PADDING

SKU	DESCRIPTION	SIZE
NL119	Round Gorilla Pad® Pool Floor Protective Padding	12-FT
NL120	Round Gorilla Pad® Pool Floor Protective Padding	15-FT
NL122	Round Gorilla Pad® Pool Floor Protective Padding	18-FT
NL124	Round Gorilla Pad® Pool Floor Protective Padding	21-FT
NL126	Round Gorilla Pad® Pool Floor Protective Padding	24-FT
NL127	Round Gorilla Pad® Pool Floor Protective Padding	27-FT
NL128	Round Gorilla Pad® Pool Floor Protective Padding	28-FT
NL129	Round Gorilla Pad® Pool Floor Protective Padding	30-FT
NL131	Round Gorilla Pad® Pool Floor Protective Padding	33-FT

BLUE WAVE® PEEL AND STICK FOAM POOL COVES

SKU	DESCRIPTION	QUANTITY
NL102	48-in Peel and Stick Above Ground Pool Cove	1
NL102-10	48-in Peel and Stick Above Ground Pool Cove	10
NL102-12	48-in Peel and Stick Above Ground Pool Cove	12
NL102-26	48-in Peel and Stick Above Ground Pool Cove	13
NL102-28	48-in Peel and Stick Above Ground Pool Cove	14
NL102-14	48-in Peel and Stick Above Ground Pool Cove	15
NL102-30	48-in Peel and Stick Above Ground Pool Cove	16
NL102-16	48-in Peel and Stick Above Ground Pool Cove	17
NL102-32	48-in Peel and Stick Above Ground Pool Cove	18
NL102-18	48-in Peel and Stick Above Ground Pool Cove	19
NL102-34	48-in Peel and Stick Above Ground Pool Cove	21
NL102-20	48-in Peel and Stick Above Ground Pool Cove	22
NL102-22	48-in Peel and Stick Above Ground Pool Cove	24
NL102-24	48-in Peel and Stick Above Ground Pool Cove	26
NL102-36	48-in Peel and Stick Above Ground Pool Cove	27

15-YEAR LIMITED WARRANTY

This product is warranted to the original purchaser to be free from defects in material or workmanship for a period of fifteen (15) years from the date of the original retail purchase.

This warranty does not cover defects or damage due to improper installation, alteration, accident, or any other event beyond the control of the manufacturer. Defects or damage resulting from misuse, abuse, or negligence will void this warranty. This warranty does not cover scratching or damage that may result from normal usage.

This product is not intended for institutional or commercial use; the manufacturer does not assume any liability for such use. Institutional or commercial use will void this warranty.

This warranty is nontransferable and is expressly limited to the repair or replacement of the defective product. During the warranty period, the manufacturer shall repair or replace defective parts at no cost to the purchaser. Shipping charges and insurance are not covered and are the responsibility of the purchaser. Labor charges and related expenses for removal, installation, or replacement of the product or components are not covered under this warranty.

The manufacturer reserves the right to make substitutions to warranty claims if parts are unavailable or obsolete.

The manufacturer shall not be liable for loss of use of the product or other consequential or incidental costs, expenses, or damages incurred by the consumer of any other use. The user assumes all risk of injury resulting from the use of this product.

This warranty is expressly in lieu of all other warranties, expressed or implied, including warranties of merchantability or fitness for use to the extent permitted by Federal or state law. Neither the manufacturer nor any of its representatives assumes any other liability in connection with this product.

All warranty claims must be made through the retailer where the product was originally purchased. A purchase receipt or other proof of date of purchase will be required to process all warranty claims. The model number and part numbers found within the assembly instructions will be required when submitting any parts requests or warranty claims.

**For further warranty information or inquiries, please call 1-(800) 759-0977.
Or, email warranty@bluewaveproducts.com**



Blue Wave Products, Inc.
101 N. Raddant Rd
Batavia, IL 60510