

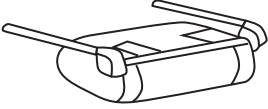









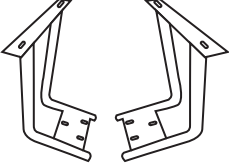

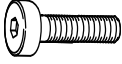

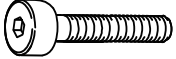
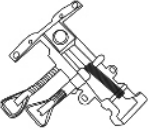
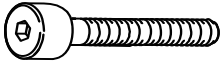
ASSEMBLY INSTRUCTIONS

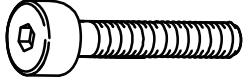
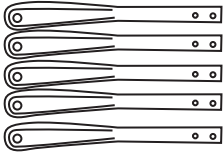
Ax1 	Kx1 
Bx1 	Lx1 
Cx2 	Mx2 
Dx2 	Nx10  M6x14mm
Ex1 	Ox14  M6x20mm
Fx1 	Px4  M6x30mm
Gx1 	Qx4  M8x20mm
Hx5 	Rx1 
Ix1 	
Jx5 	

Please check that all parts are present before beginning installation.

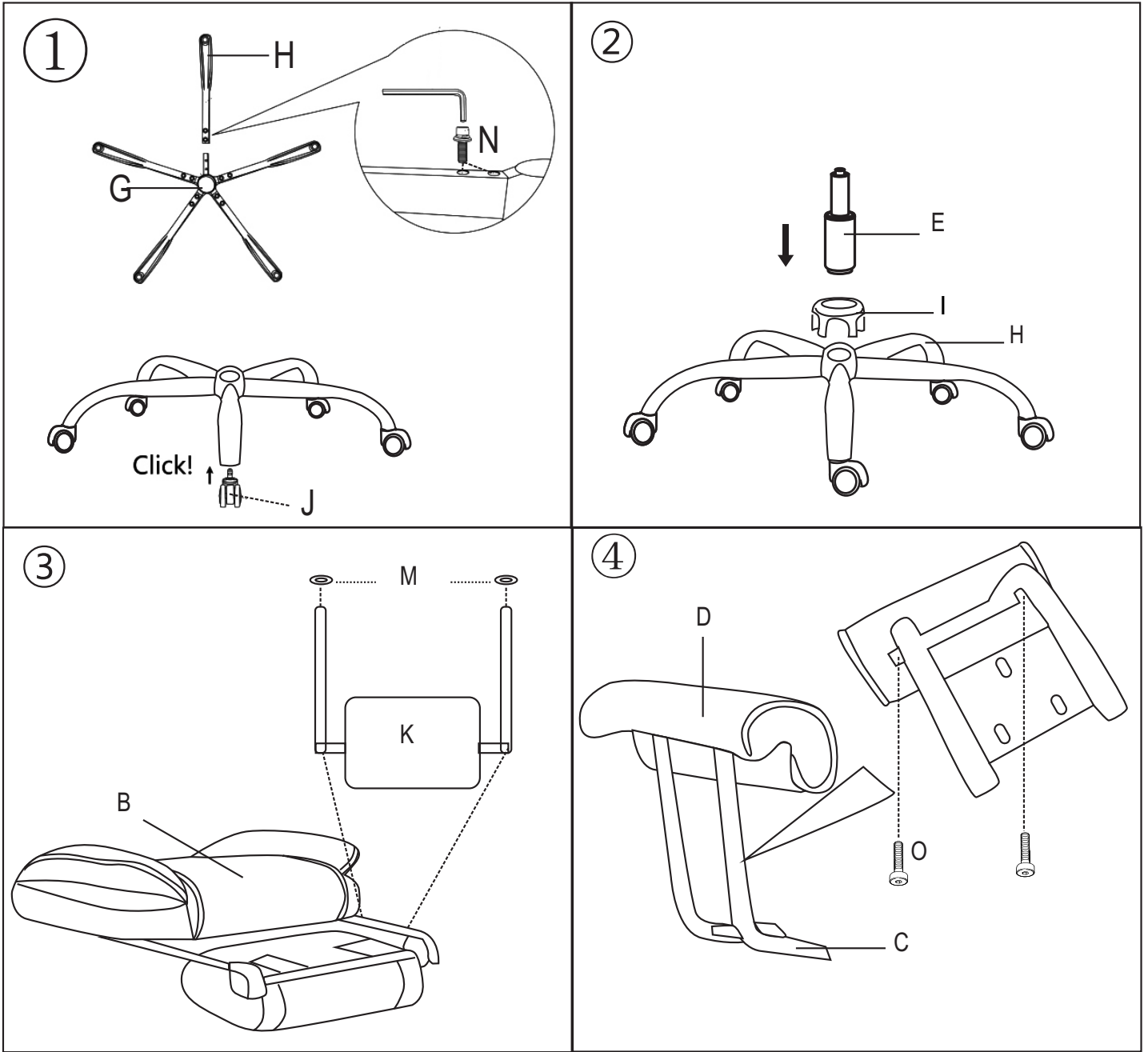

Please follow steps 1 to 4 to properly install the base, footrest and 2 armrests.

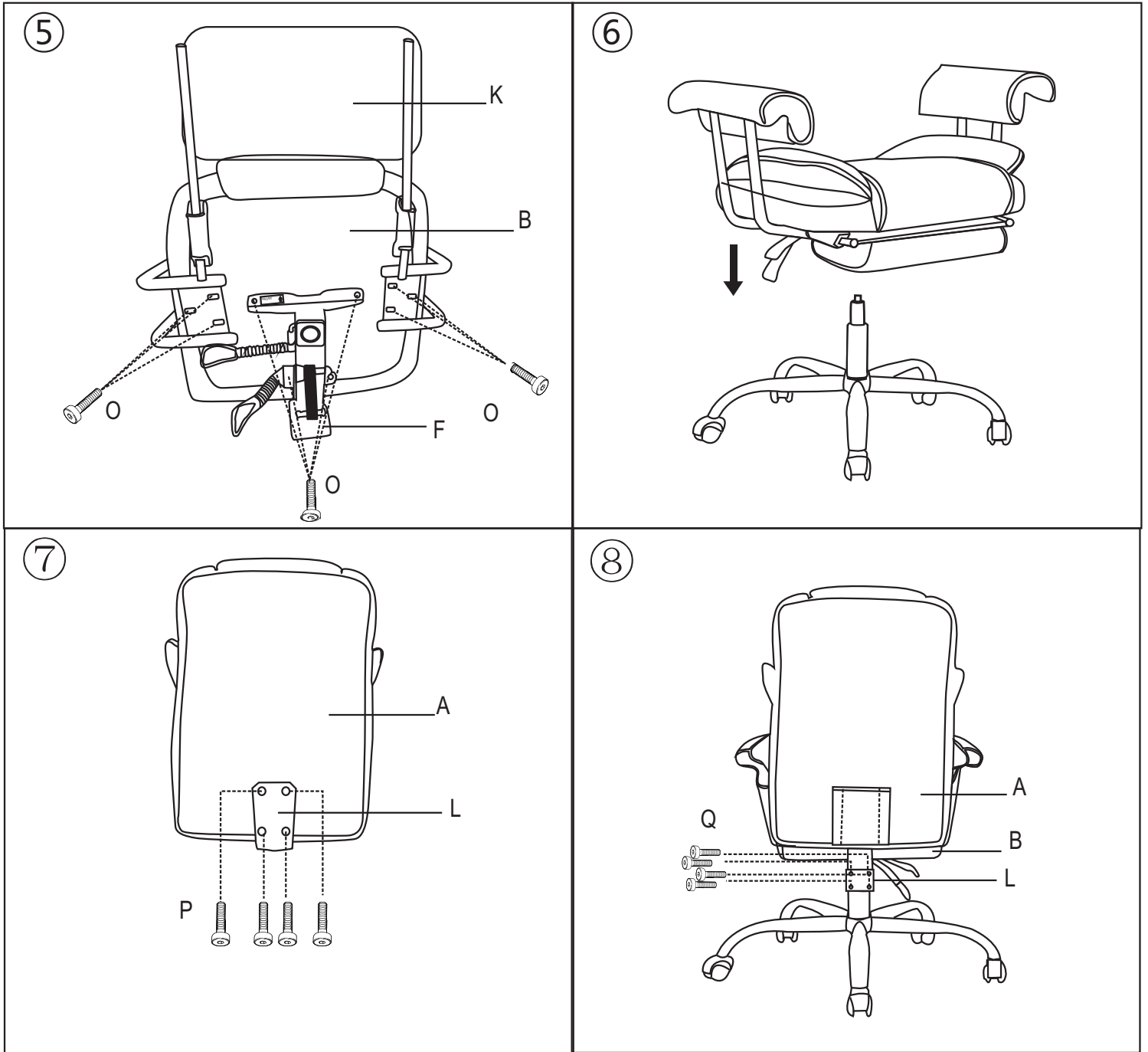

Please follow steps 5 to 8 to install the armrests and footrest on the seat. Then assembled the base, the backrest and the seat.

9

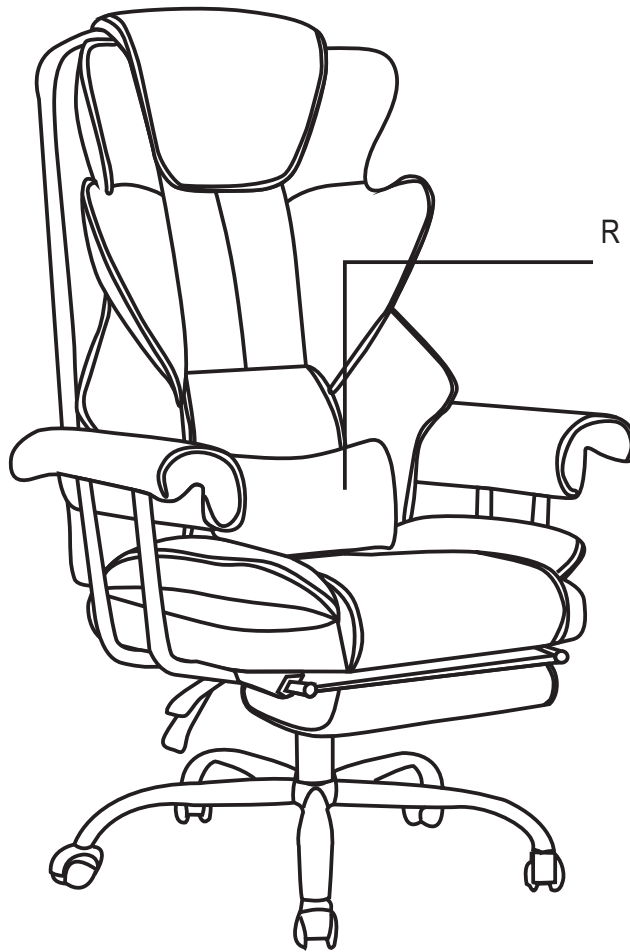

Thank you for choosing our store for your purchase.

Bringing a good shopping experience to all our customers is always our responsibility.

But sometimes the product you received will encounter some problems, and it may be caused in the delivery route or otherwise. In this case, please contact us with some photo of the problem through your purchasing platform (Just don't forget to tell us your order number). And our after-sales team will contact you with suitable solutions.

Thank you for your support.