

# ALUMINUM SWIVEL CHAIR

## INSTRUCTION MANUAL

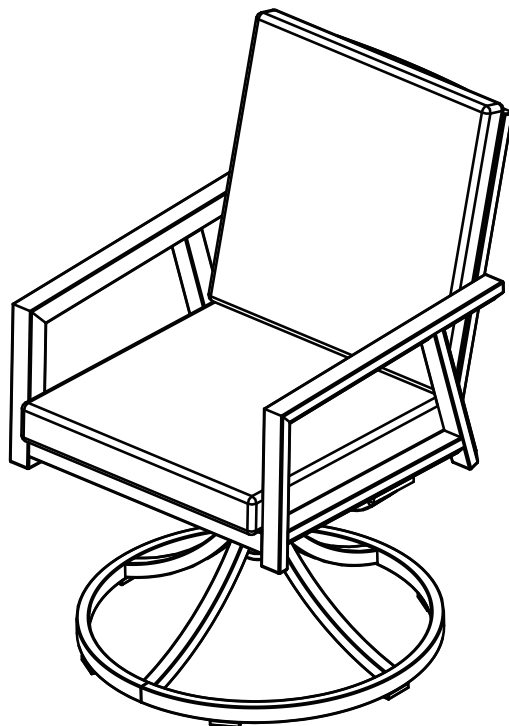

### **FOR YOUR SAFETY!**

Read the instruction manual before assembling and using.

### **CONTACT FIRST!**

If you have any questions that are not addressed in this manual or you need help, please contact your local dealer or our customer service.

## GENERAL INFORMATION

In case of any issue, call your local dealer first! **DO NOT RETURN** the furniture. This product has been made to high-quality standards. If you have questions not addressed in this instruction manual concerning assembly, operation or you need parts, consult your dealer or call our direct customer service hotline.

Patio Time appreciates your trust and purchase for supporting your home decorating plan. Our customer service department is available from Monday to Friday, 9:00 AM~5:00 PM, EST, if necessary, to replace damaged or missing parts. To help expedite our service, please have these assembly instructions readily available along with your original order receipt. For warranty terms and conditions, please read through the Warranty Card accompanied in the packaging box.

## PRE ASSEMBLY TIPS & ADVICE

After unpacking, please check if the parts show any damage. In addition, please check if all parts and hardware are in position before assembly. If there is any damage or missing, please **DO NOT** assemble first and contact your local dealer for help. If you do not have the parts or hardware lists, you can require your dealer to send you immediately.



Do not use the furniture unless it is **COMPLETELY** assembled and all parts are securely fastened and tightened.

We certainly understand building ready-to-assemble furniture can be a challenging experience for some individuals. To help avoid confusion, we have provided some helpful tips that may speed up the process.

- ✓ Assembling near the area of the intended location is highly recommended.
- ✓ Make sure you have enough space to move around during the assembly.
- ✓ Use cardboard, blankets or a carpeted area while assembling furniture to prevent scratches.
- ✓ Make sure the furniture rests on a flat and level surface with each leg evenly touching the floor.



Some parts may contain sharp edges. Wear protective gloves (not included) if necessary.



Turn clockwise to tighten and only tighten when the step is completed or when instructed to do so.



After two weeks, check and tighten any loose hardware and repeat every one to two months thereafter or as necessary.



Always have at least two people to help with transporting and assembling the product to avoid potential injury and/or damage.

IT IS THE USER'S RESPONSIBILITY TO MAINTAIN THE FURNITURE. THE HARDWARE MAY LOOSEN OVER TIME AND MAY CAUSE THE FURNITURE TO BE WOBBLY AND UNABLE TO SUPPORT ITS INTENDED WEIGHT CAPACITY. THIS MAY LEAD TO COLLAPSE AND MAY CAUSE SERIOUS INJURY.



FAILURE TO FOLLOW THE GUIDELINES BELOW MAY RESULT IN INJURY AND/OR PROPERTY DAMAGE.

## CLEANING AND MAINTENANCE

This furniture can be applied to both indoor and outdoor environments. For your furniture to last, correct assembly and proper maintenance are necessary. Please take time to read and follow the instructions below. Use the furniture as described in this instruction manual to fully enjoy your furniture. We also advise you retain this manual for future reference.

To avoid damages to your furniture legs, frame and/or the floor, please make sure to move the furniture by LIFTING rather than pulling or pushing it when transporting or adjusting the placement. Check the stability of bolts, nuts and nut caps in priority. Tighten up them after one(1) to two(2) months' use whenever required. Avoid improper use and be careful not to scratch or damage the surface with sharp objects.



Patio Time will not be liable for any damage caused by improper use.

## Cushions

Our cushions do have zippers, however the **zippers are for production use only** and we extremely **do not** recommend removing the cover from the fill. The cushions are not waterproof but water repellent. This means light rain will bead off the cushion surface, but under intense rain, the water will find its way into the pillow.

Although our cushions are water repellent (not water-resistant) and UV-resistant, we do recommend bringing them indoors when not in use to preserve their lifespan and keep them looking beautiful. Clean spills or stains instantly for better maintenance. Sweep dirt or grime regularly to avoid penetrating the cushions.

1. Choose a beautiful sunny day in your yard.
2. Use a sponge, clean towel or soft scrub brush with warm soapy water solution to clean the cushion.
3. Gently scrub and wipe until the cushion is clean.
4. Rinse the area with a clean damp sponge to remove all soap residue and avoid water spots.
5. Hang outside to air dry until the cushion is completely dry.

### **WARNINGS**

- DO NOT REMOVE COVERS FROM THE FILL.
- Do not bleach to clean.
- Do not put cushions in the dryer.
- Do not submerge cushions in water.
- Avoid direct contact with the sun for a long time.
- Avoid using abrasive cleaners or hard bristle brushes.

## Aluminum

Our aluminum patio furniture is made from great quality aluminum for guaranteed strength and solidity. You also don't have to worry about sacrificing style for durability for we have possessed a huge variety of collections. However, there are care and maintenance needed to be mentioned. Before cleaning your aluminum surfaces make sure the furniture is not hot from sun exposure.

1. Remove the cushions from the furniture.
2. Prepare a water and mild detergent solution.
3. Spray the solution on the dirty area.
4. Use a soft and dry cloth or a sponge to clean the surface.
5. Rinse with clean water and allow the furniture air-dry completely before replacing cushions.
6. Tighten up bolts, nuts, and nut caps after using them for a while.

### **WARNINGS**





- Never use hard bristle brushes, abrasive cleaners, or bleach products on frames.
- Avoid pulling or pushing the furniture to avoid any damage to the floor, legs, and frame.
- Use covers to protect the furniture or store it indoors when not in use.

## Storage





1. Clean your appliance before storage.
2. Store at a cool dry place either outdoors or indoors, but make sure to disconnect and remove LP cylinder from the appliance.
3. A cover is highly recommended to protect your appliance (purchase separately from any online shops ).
4. Perform a Leak Test before using the appliance after it has been kept in storage

## ASSEMBLY INSTRUCTIONS

### Parts List

Parts No.	A	B	C	D	E
Images					
Qty.	1	1	1	1	4

### Hardware List

Key	H3	N42	L04	L05	L06
Images		 M8*42			
Qty.		4	4	4	4

### Exploded View

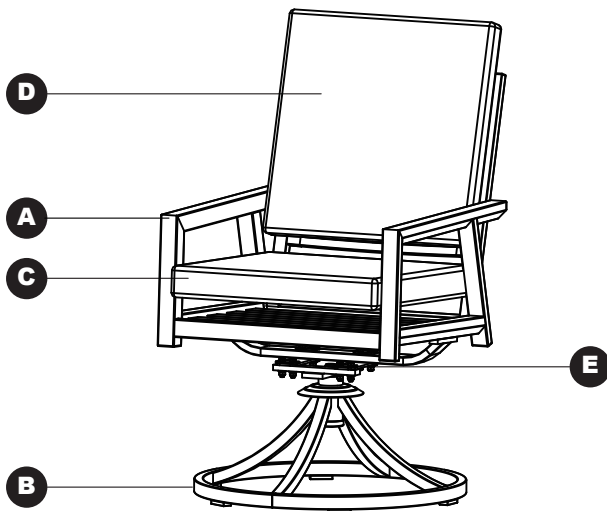

# 1



## CAUTION

Note: Don't tighten screws before final assembling.

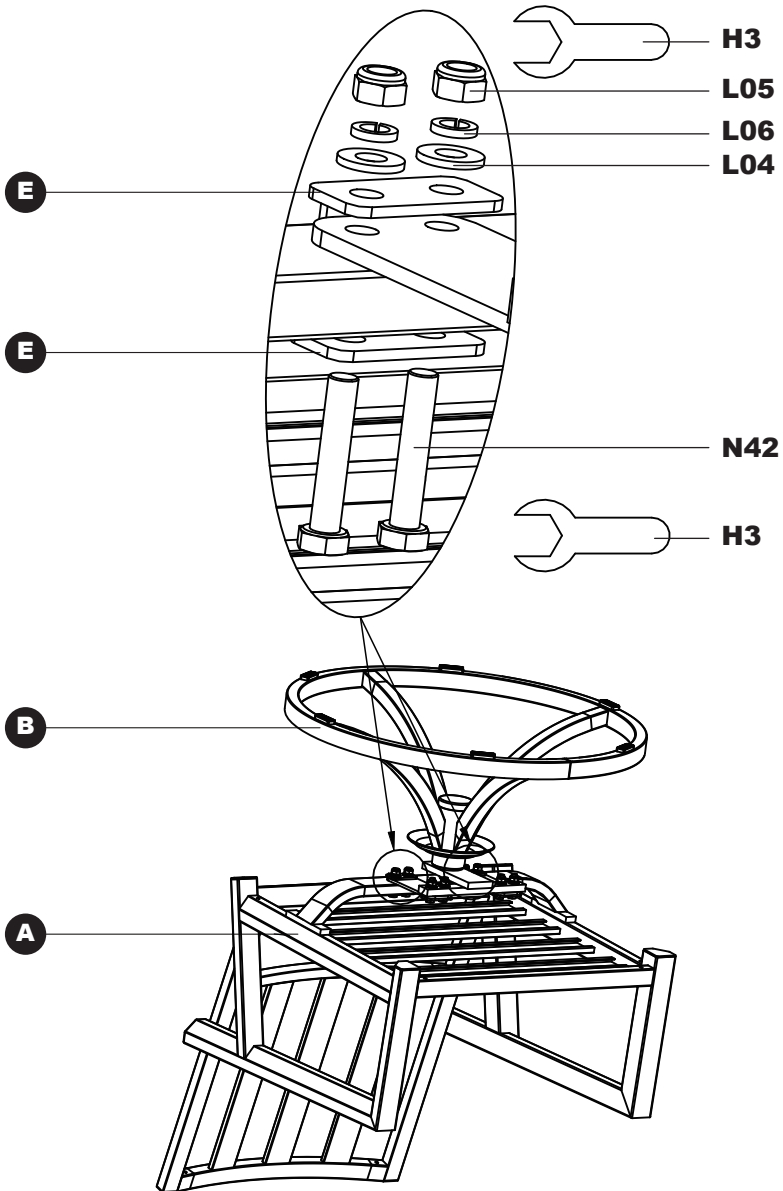

2

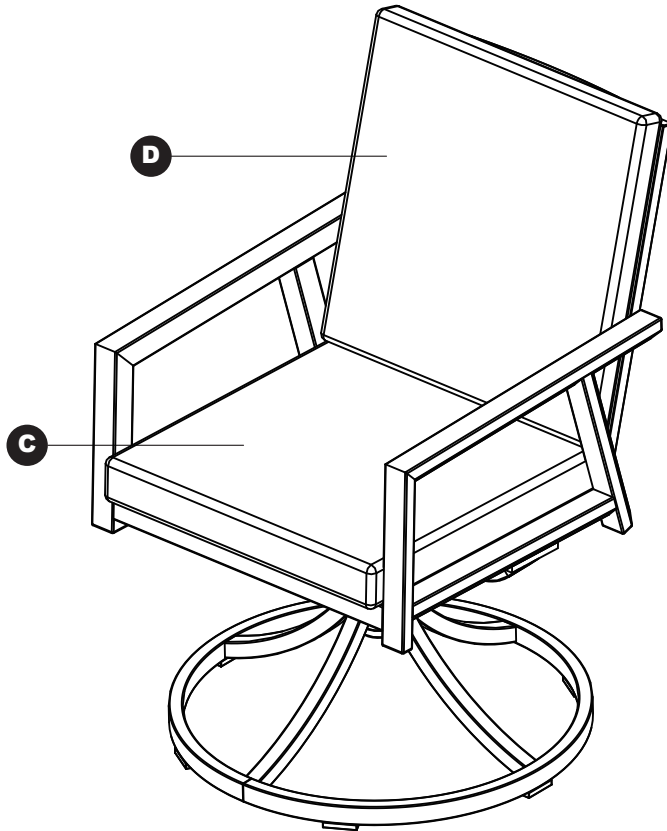

**ASSEMBLY COMPLETED**

- ✓ Please ensure the furniture stands on a flat and level surface.
- ✓ If the product wobbles or feels loose, double-check all bolts and nuts are properly tightened and secured.