

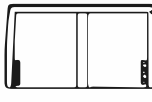









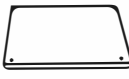
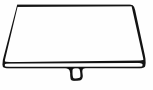
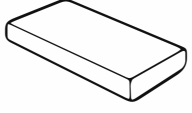











## Accessories list(sitting sofa)

### Carton 1/2

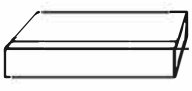
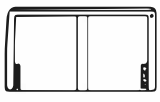
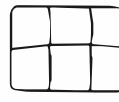
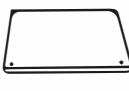
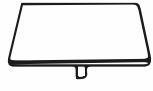
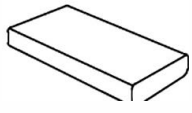
A  Left seat frame(1)	B  Left backrest(1)	C  Backrest cushion(2)	D  Ottoman base plate(1)	E  Ottoman panel(1)	
F  Double seat cushion(1)	G  Ottoman seat cushion(1)	H  Left armrest(1)	I  Ottoman side panel(4)	J  812#Sofa feet(14)	
K  Metal plate(2)	L  8*35 Screw(4)	M  16mm Gasket(4)	N  Corner brace connector(8)	O  M5*100*55 Wrench(1)	P  16mm Gasket(32)
Q  6*16 Corner brace screw(32)	P  M4*100*30 Wrench(1)	R  50#Metal plate(1)	S  6*25 Screw(2)	T  13mm Gasket(2)	U  M4*65*23 Wrench(1)

### Carton 2/2

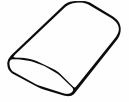
V  Right seat frame(1)	W  Right backrest(1)	C  Back cushion(2)	D  Ottoman base plate(1)	E  Ottoman panel(1)
F  Double seat cushion(1)	G  Ottoman seat cushion(1)	X  Right armrest(1)	I  Ottoman side panel(4)	Y  Armrest sofa bag(2)

STEP1:

Install sofa feet to the base plate of ottoman with hardware  
Note: Hardware face the smooth surface of ottoman base.

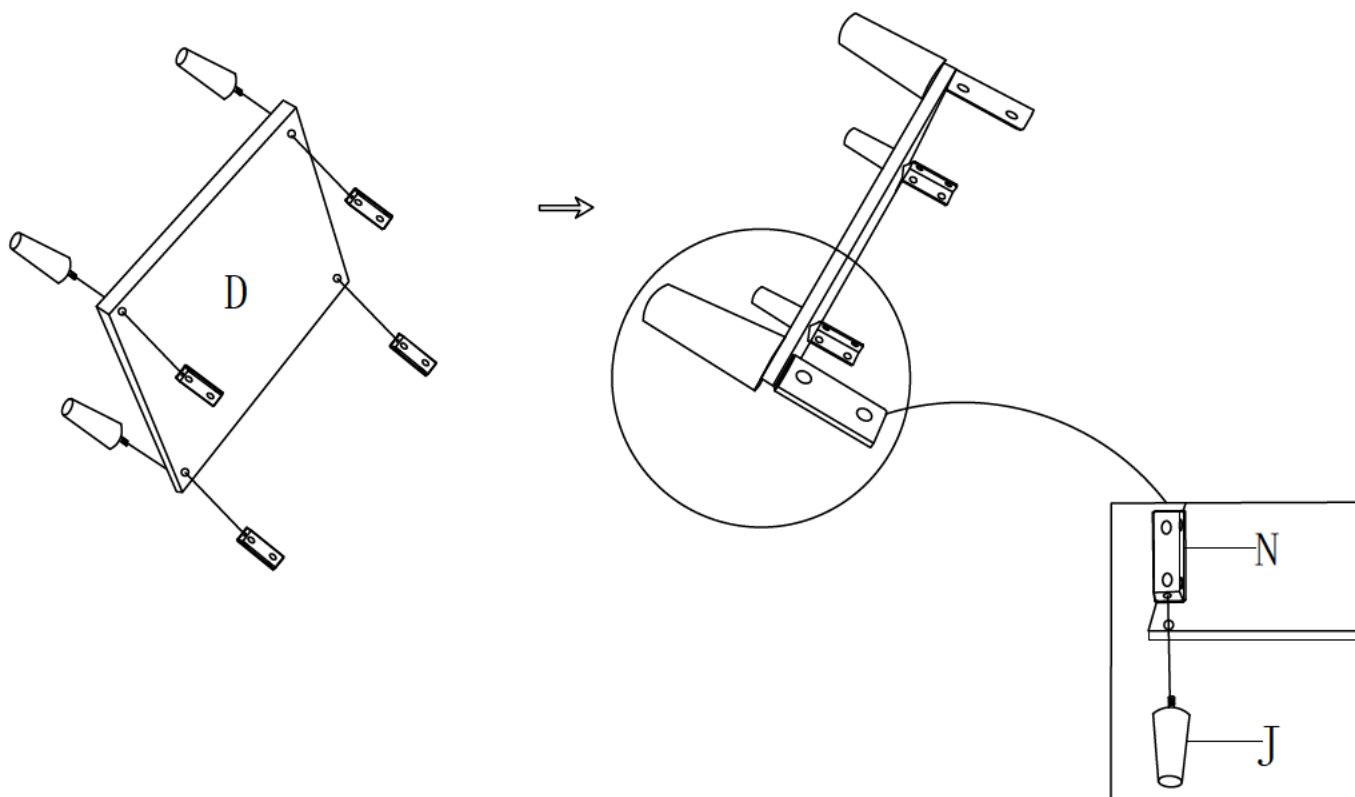

STEP2: Connect the side panels of ottoman to the base plates with conner brace connector. Note: please distinguish between top and bottom of the side panels

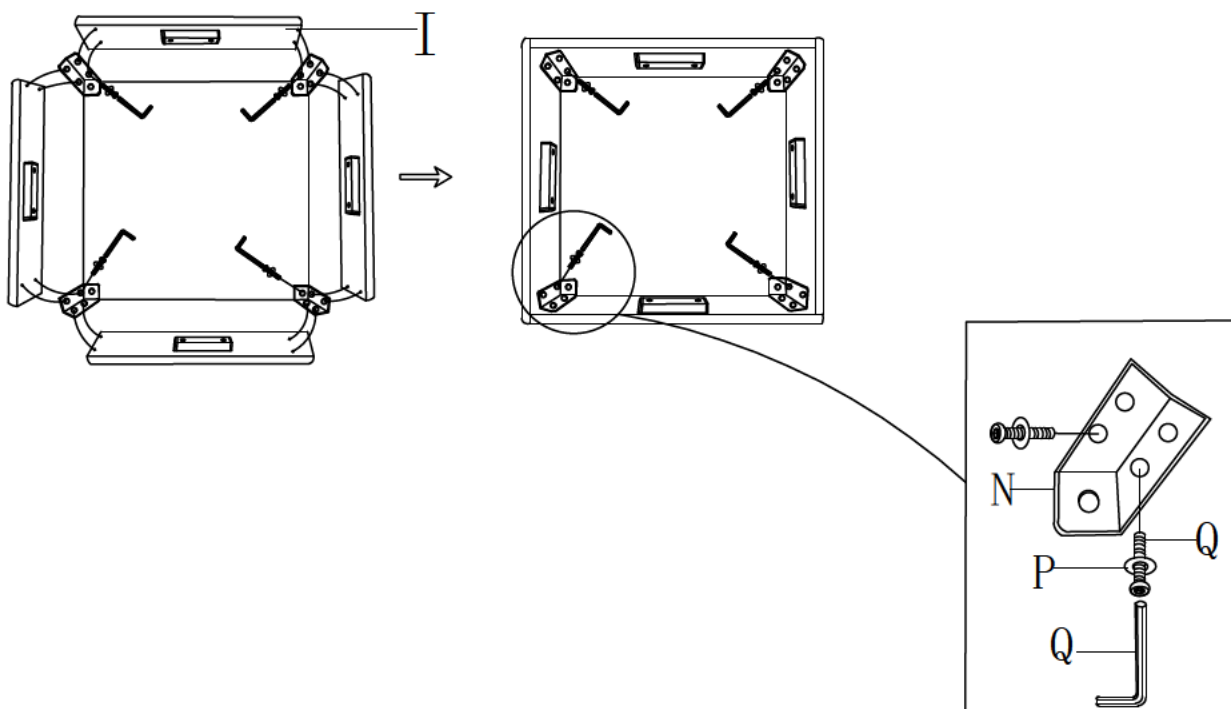

STEP3: Place the ottoman panel on the ottoman frame

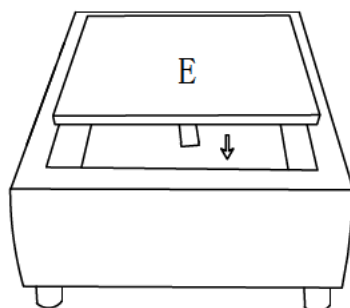

STEP4: Install the right armrest to the right seat frame.

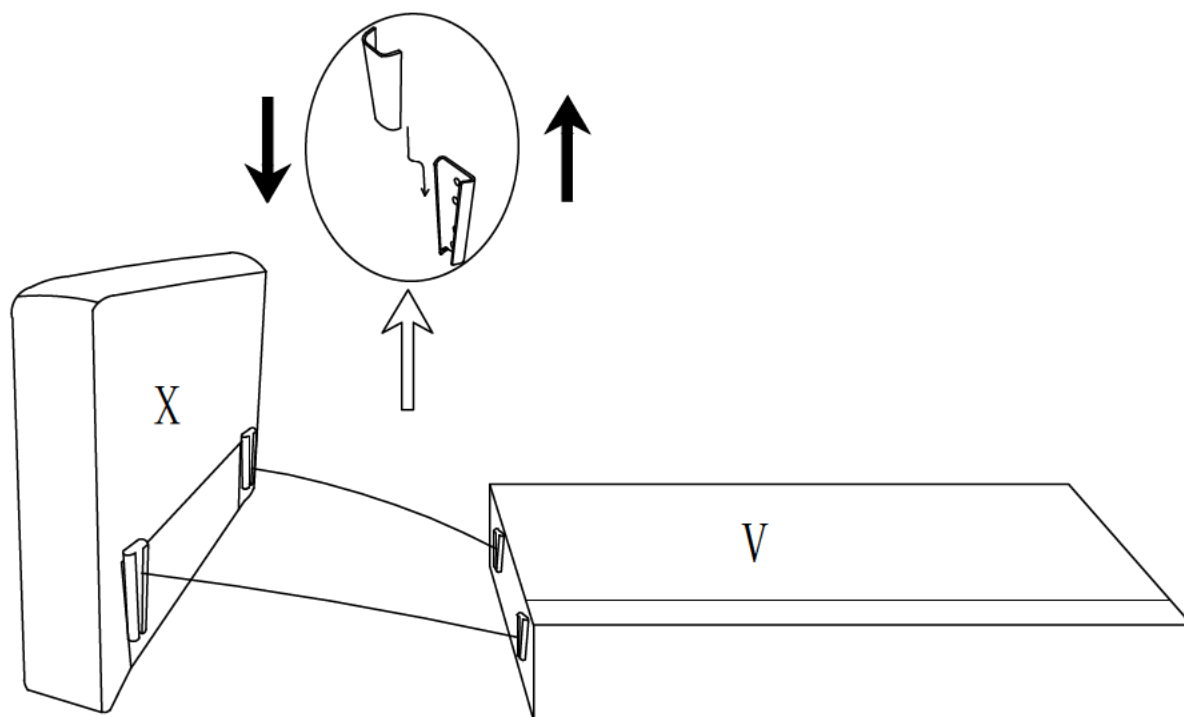

STEP5: Install the left armrest to the left seat frame.

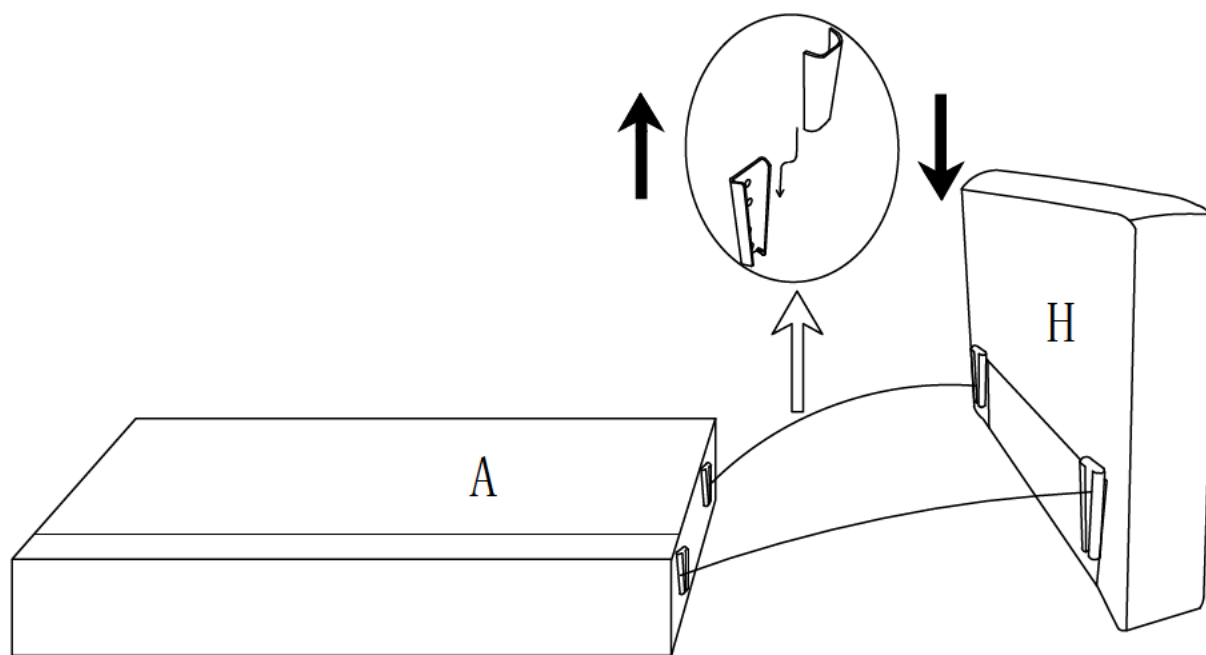

STEP6: Connect the fixed hardware in the middle of the sofa and install the sofa feet.

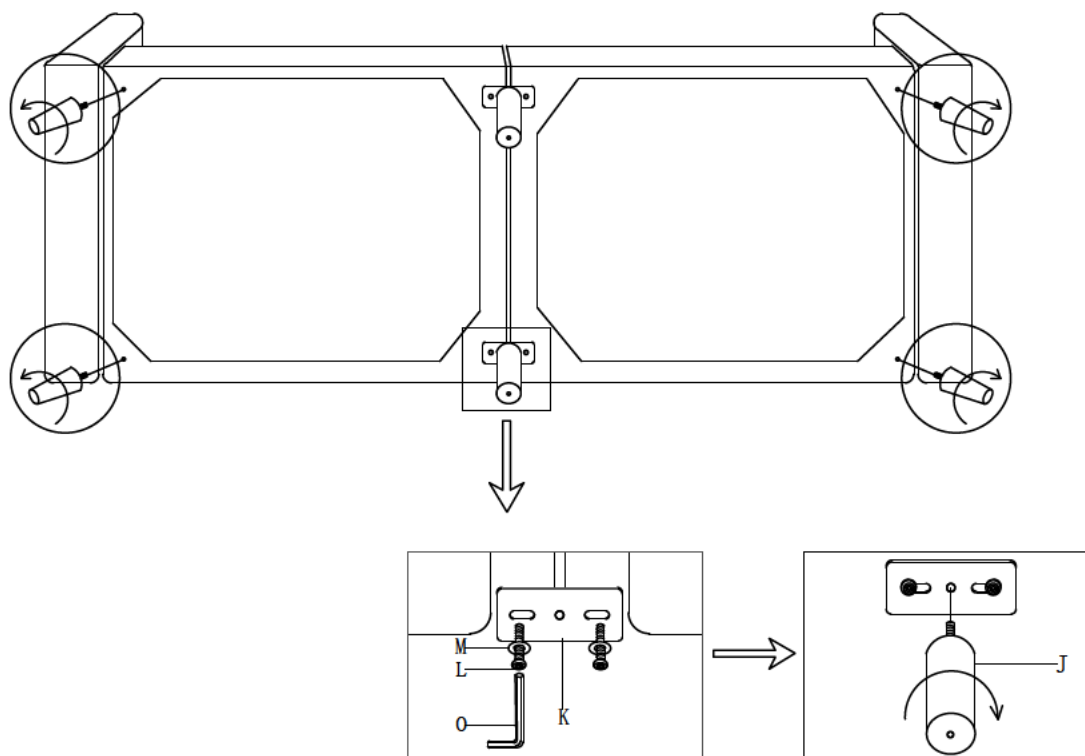

STEP7: Insert the backrest into the sofa base

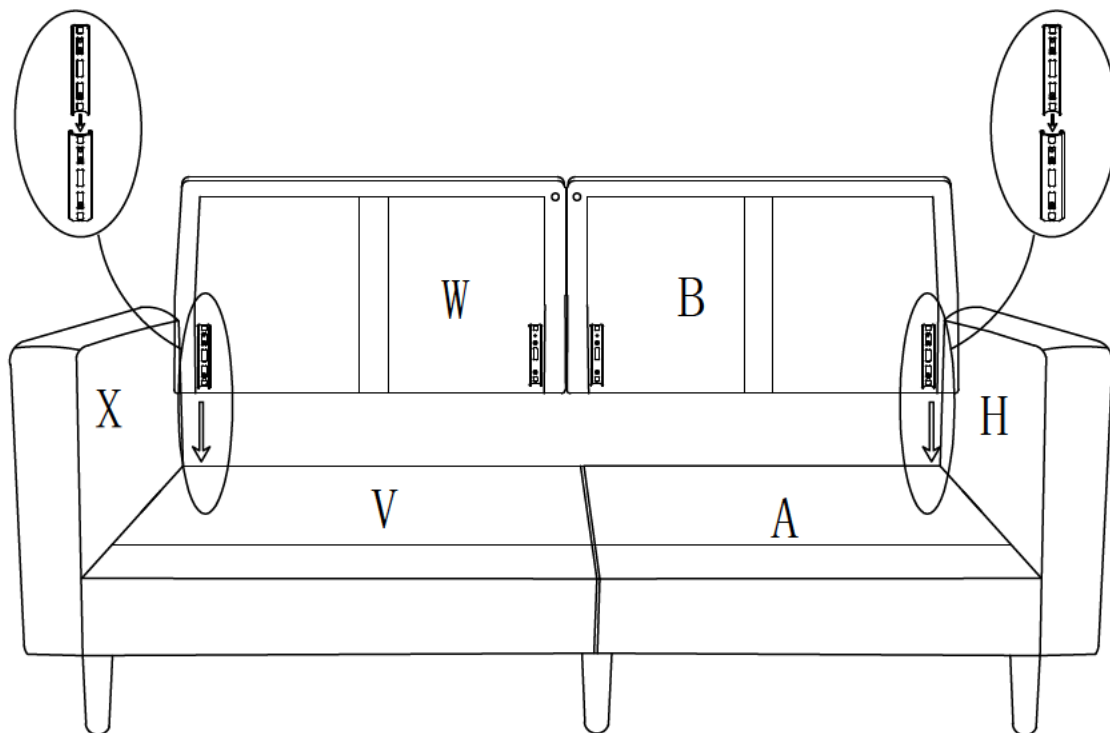

STEP8: Lock the backrest with the metal plate

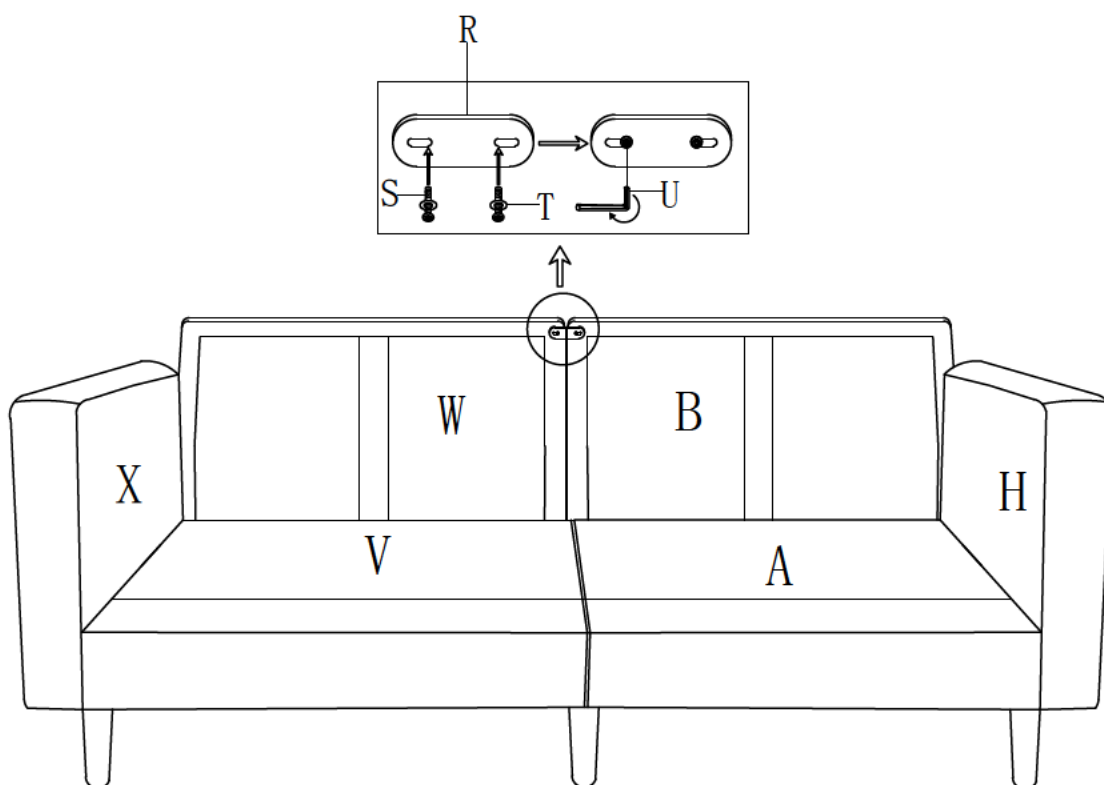

STEP9: Cut the compressions bags

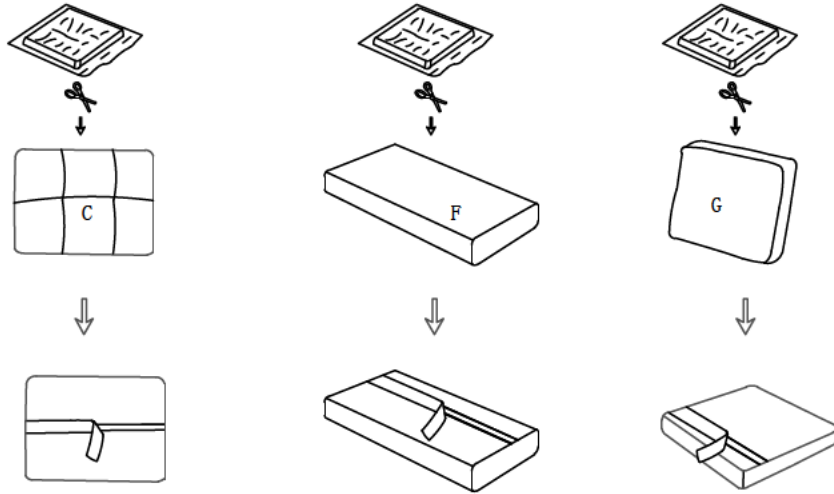

STEP10: Put the seat cushion and then the back cushions on the sofa

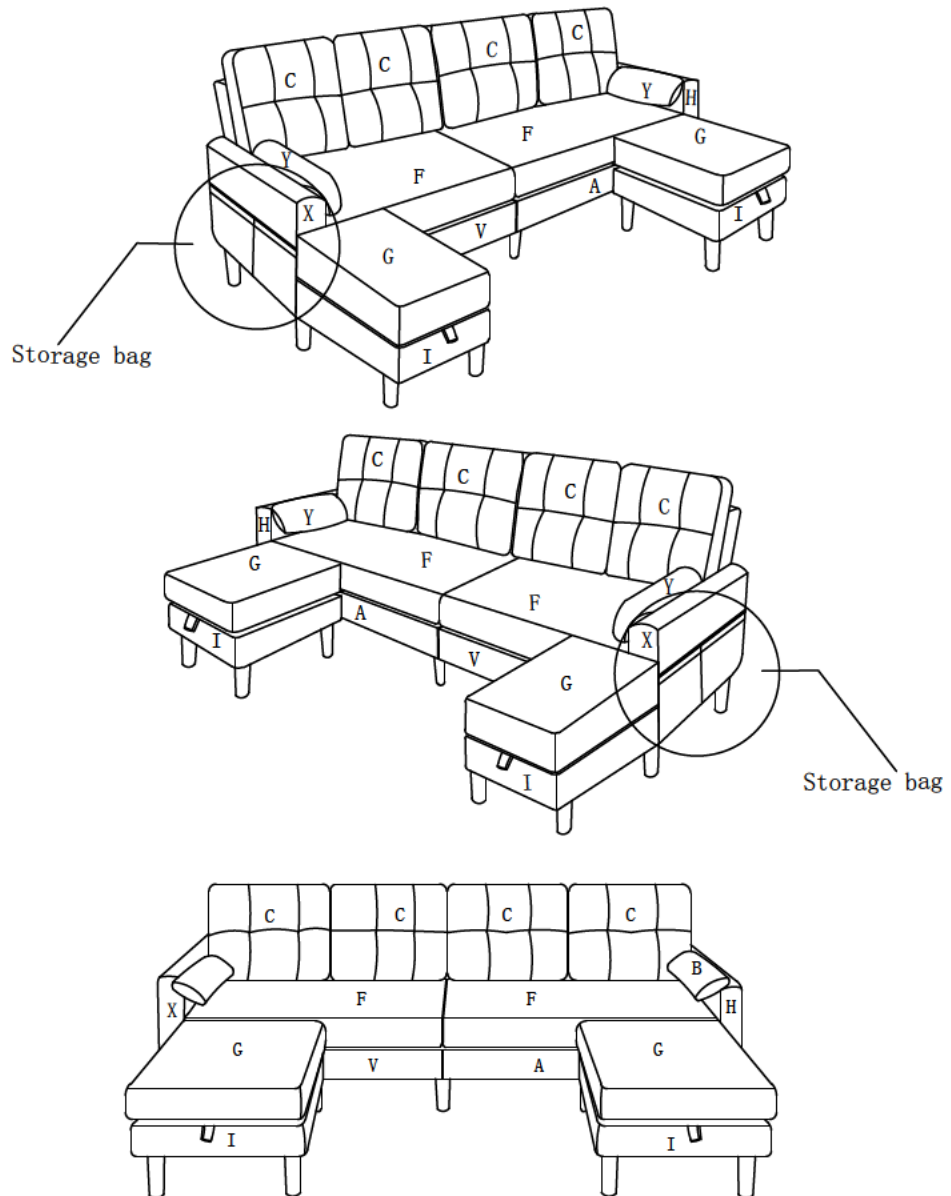



# OTTOMAN

## Accessories list

A

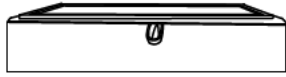

Ottoman frame with coffee table (1)

B

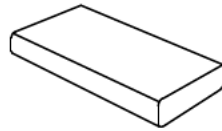

Seat cushion(1)

C



Sofa feet(4)

STEP1: Install the ottoman feet

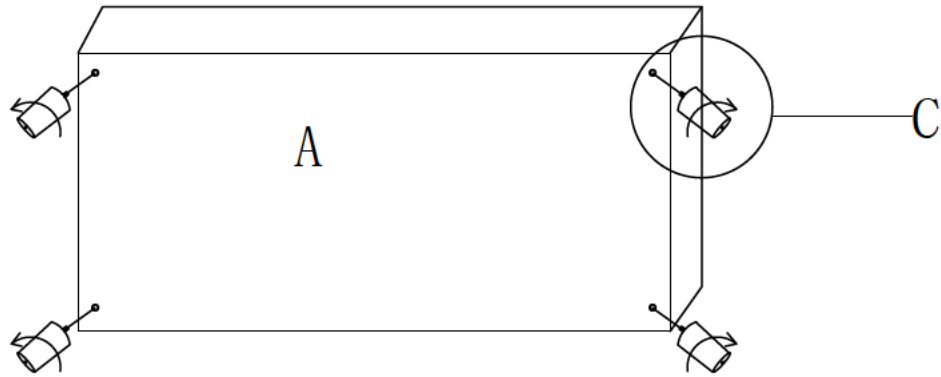

STEP2: Cutting open the compression bag.

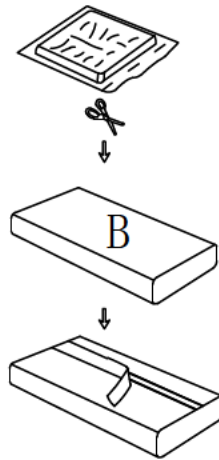

STEP3: The assembly is complete

