

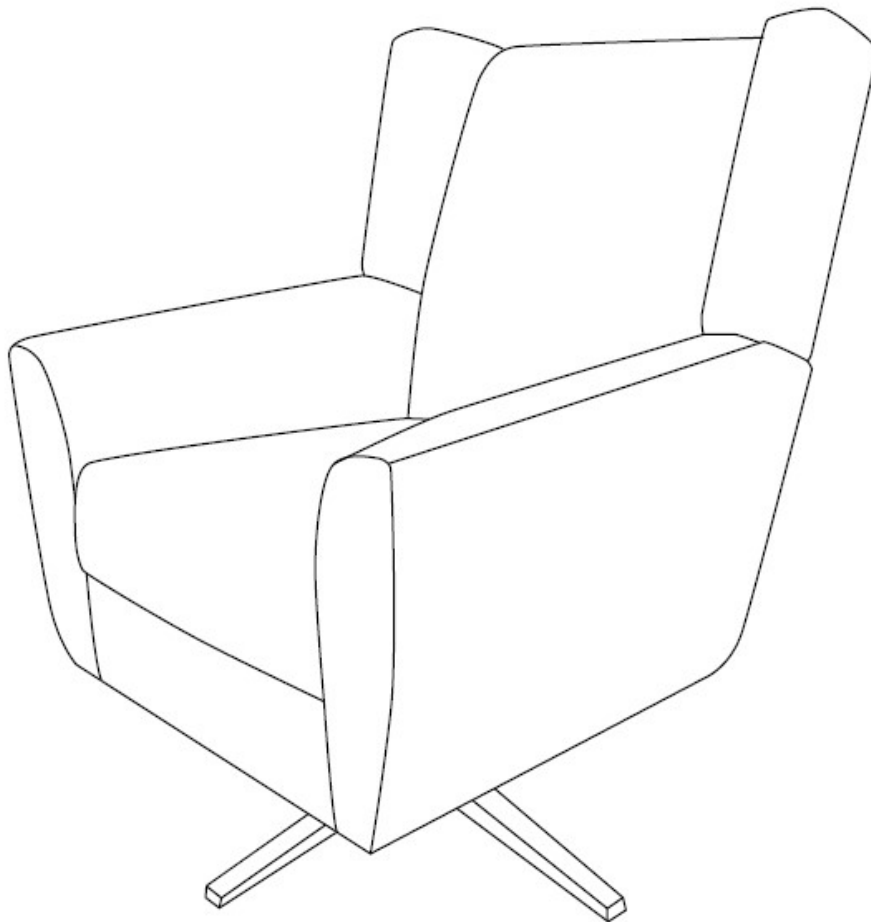



Assembly Instructions

Caution : You must read this before you proceed

SWIVEL CHAIR

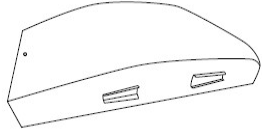

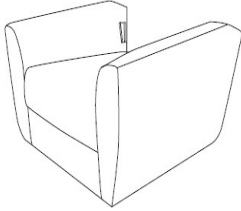

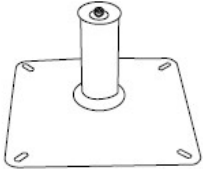





Parts List

Label	Picture	Description	QTY
A		Chair Backrest	1
B		Right Wing	1
C		Left Wing	1
D		Chair Base	1
E		Chromed Base	1
F		Chassis Part	1

Hardware

Label	Picture	Description	QTY
①		Bolt(M8*40mm)	5

②		Flat Washer	5
③		Spring Washer	5
④		Allen Key(S6)	1
⑤		Bolt(M8*20mm) (Spare Bolt)	1
⑥		Bolt(M6*40mm)	3
⑦		Flat Washer(M6)	3
⑧		Allen Key(S4)	1
⑨		Bolt	1

Assembly Preparation

Before Beginning Assembly :

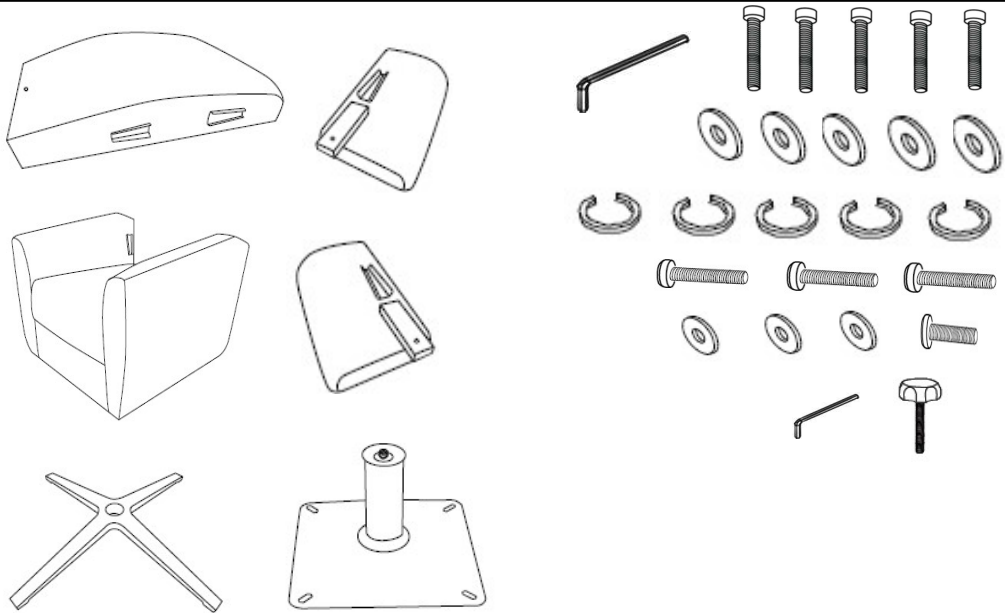

- Read instructions, cover to cover-



- Have 2 adults on hand for assembly-



- Do not assemble on flooring or carpet-



- Assemble on a clean non-marring surface (packing foam)-



- Save all packaging until finished-

Assembly Steps

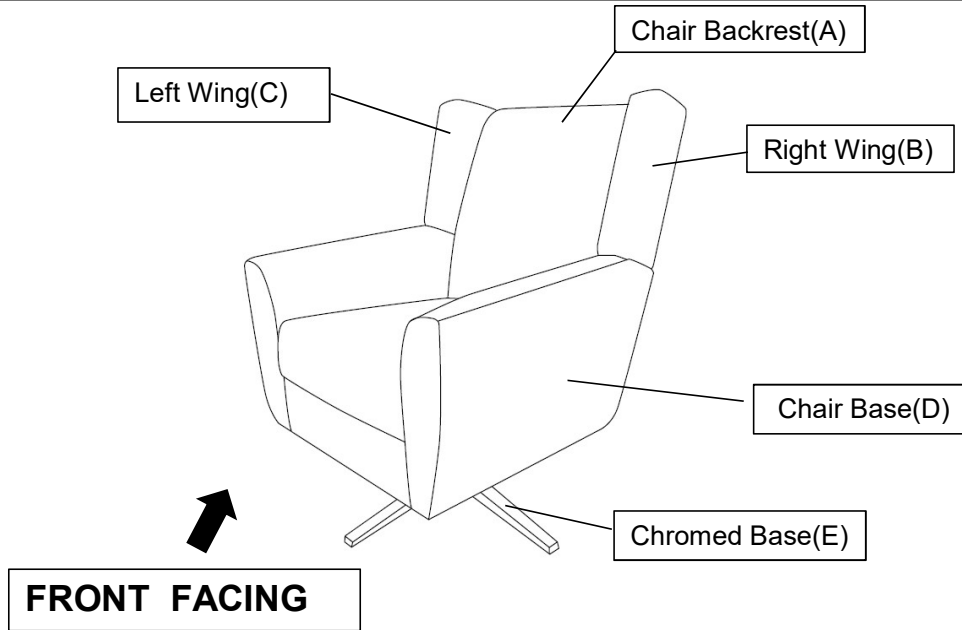

This Swivel Chair has multiple parts and may require up to 30 minutes to assemble. To give you an overview of the Swivel Chair parts, the above picture is to help you put the various parts into perspective. Please read through the instructions below to familiarise yourself with the parts and steps before assembly.

Step 1

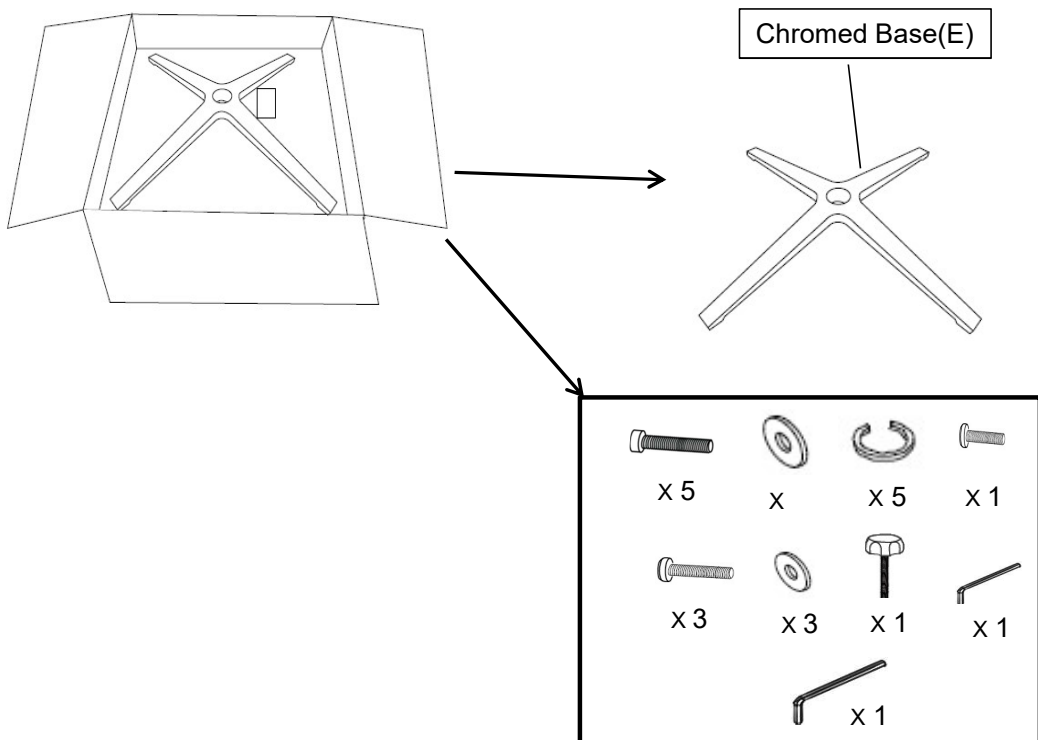

Open the carton place all parts on a clean non-marring surface. Remove Chromed Base(E) and Hardware from inner box.

Step 2

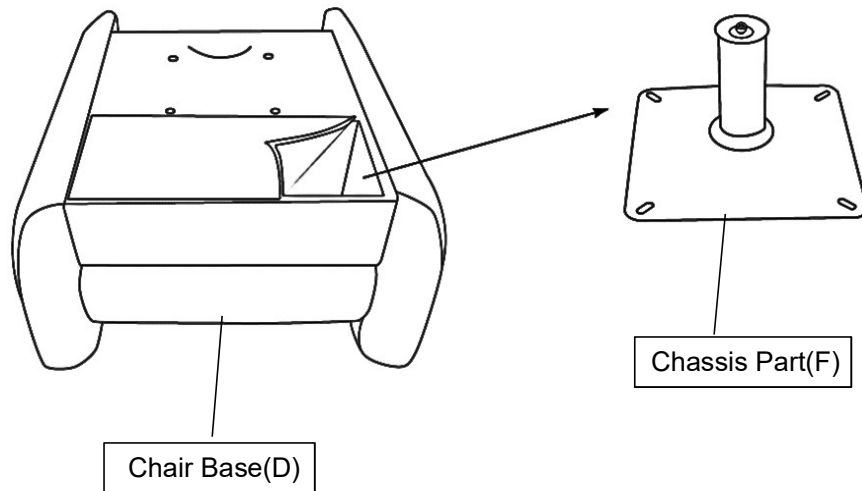

Turn over the Chair Base(D), remove the Chassis Part(F) from the bottom of Chair Base(D).

Step 3

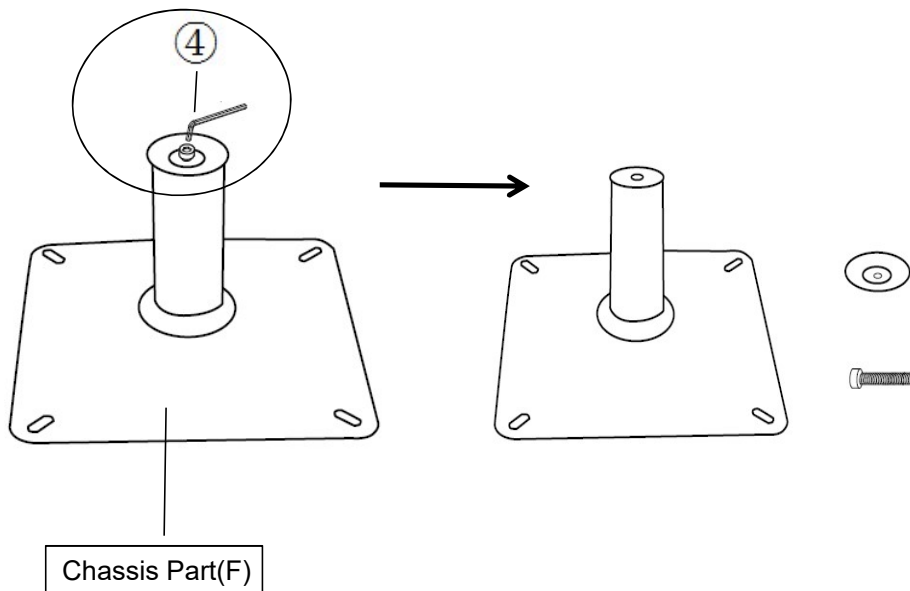

Loosen the preserved bolt and washer on the end of Chassis Part(F) with Allen Key(S6)(④) as shown above.

Step 4

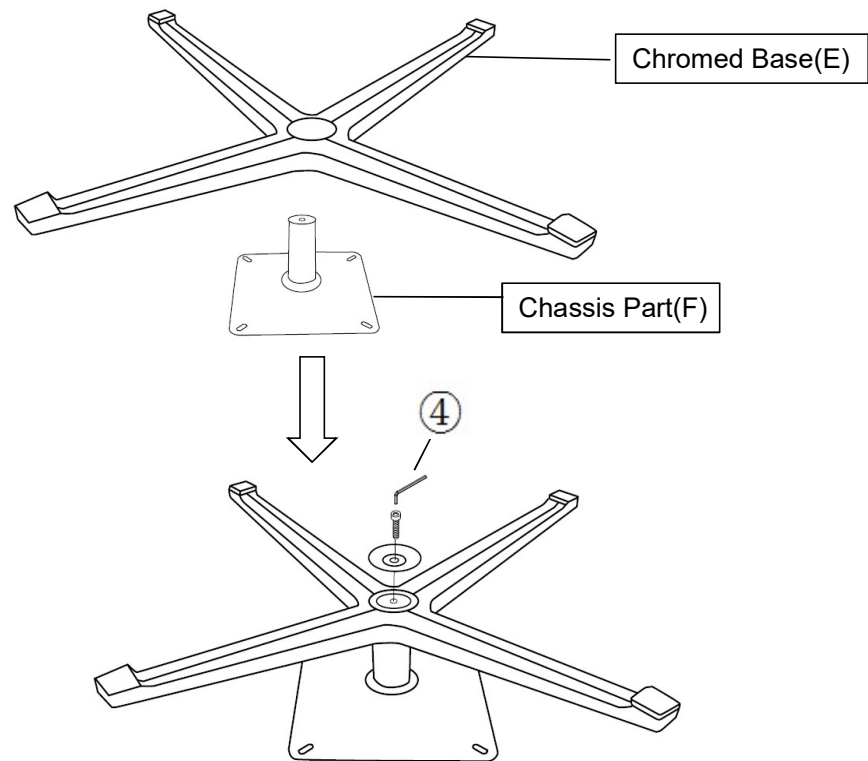

Attach the Chromed Base(E) to the Chassis Part(F) with the preserved bolt and washer turning clockwise by Allen Key(S6)(4) until tight.

Step 5

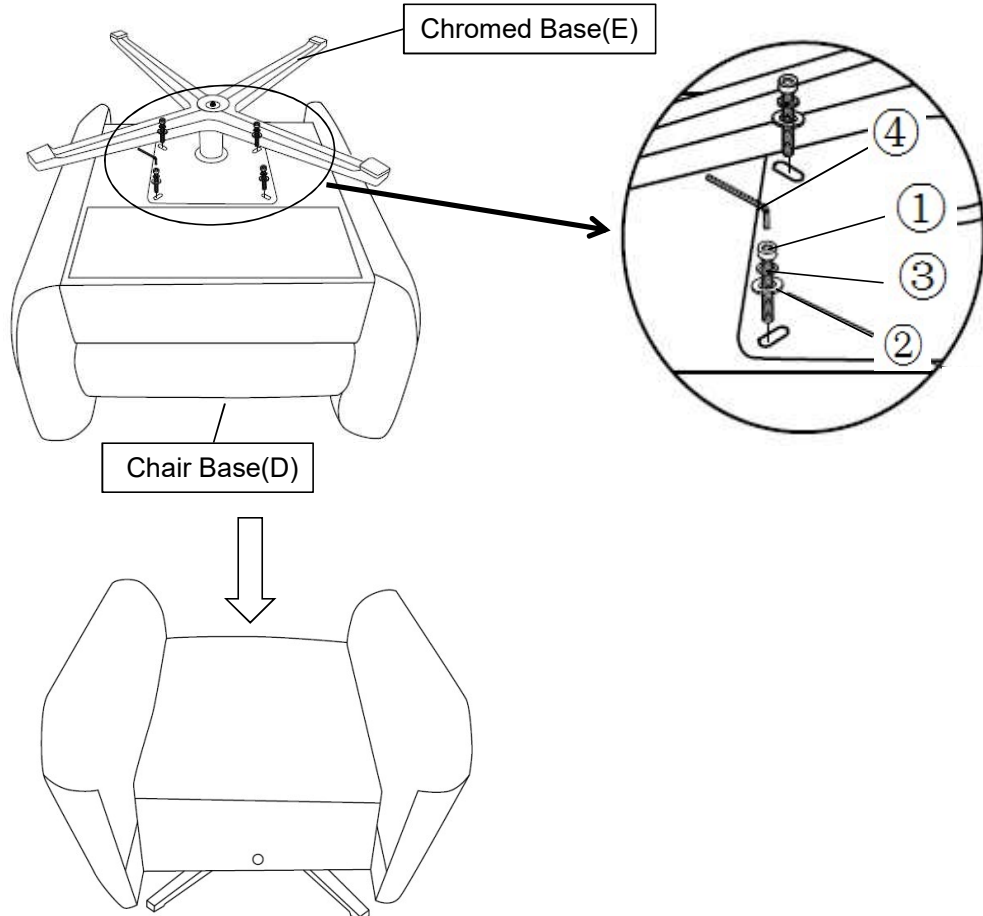

Attach the Chromed Base(E) to the bottom of Chair Base(D) using Bolt(①),Spring Washer(③),Flat Wash(②) with Allen Key(④) by turning clockwise until tight.
Then turn the Chair Base(D) right side up.

Step 6

Step 6.1

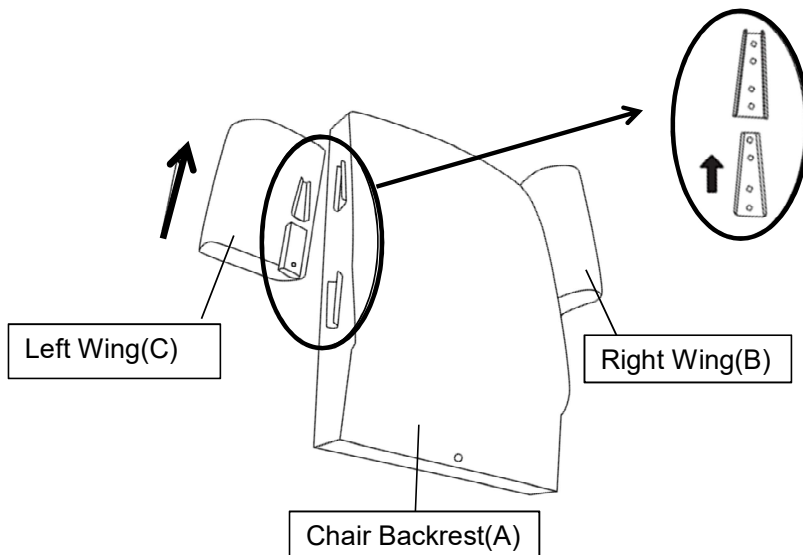

Step 6.2

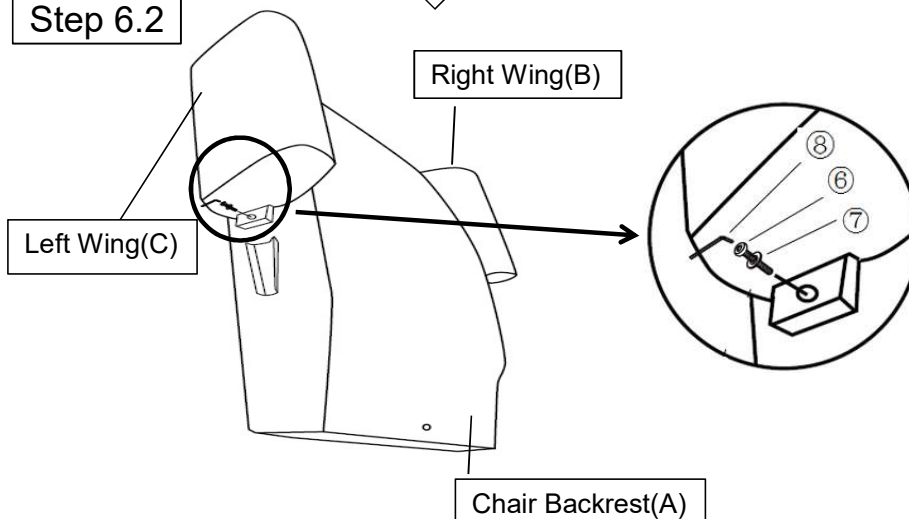

Step 6.1 Holding the Chair Backrest(A) ,take the Left Wing(C) slip into insert of Chair Backrest(A) as shown above.

Step 6.2 Attach the Left Wing(C) to the Chair Backrest(A) using Bolt(⑥),Flat Washer(⑦),with Allen Key(⑧) by turning clockwise until tight.

Repeat the same step to install the the Right Wing(B).

Step 7

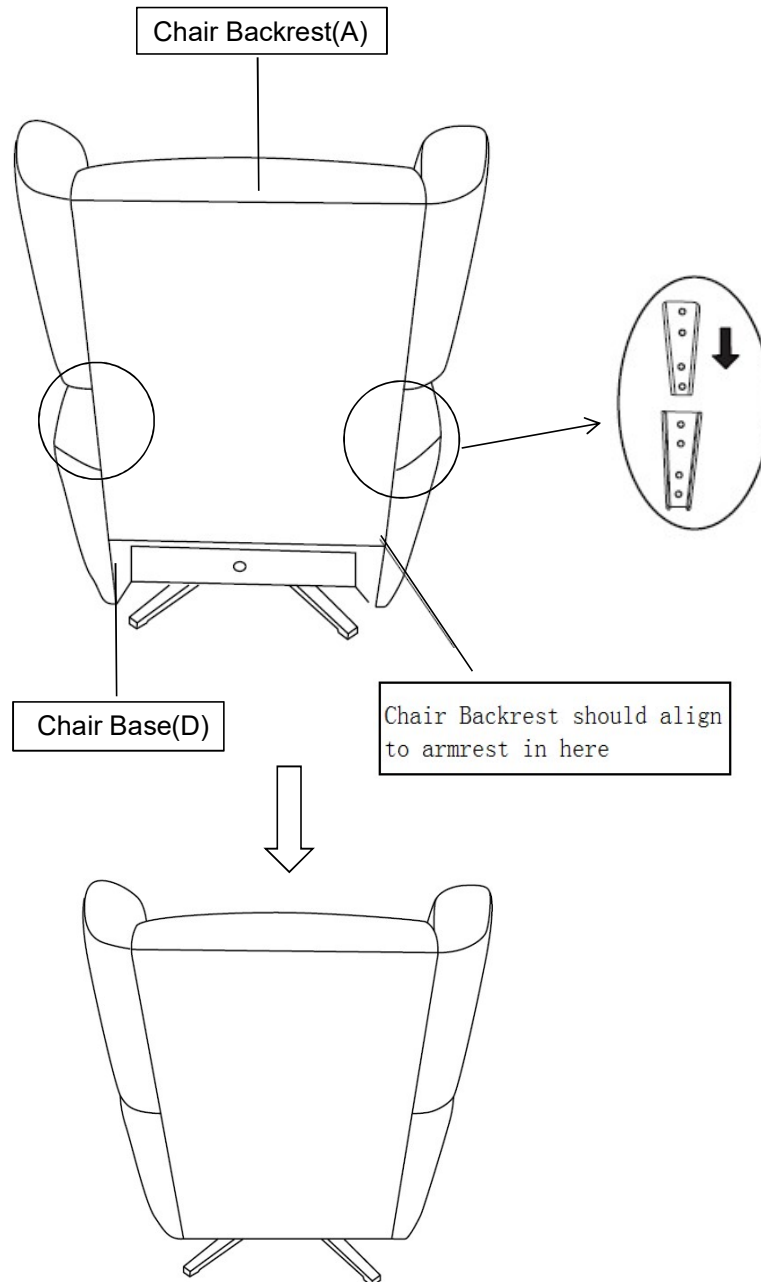

Standing behind the Chair Base(D) while holding Chair Backrest(A), slip insert of Chair Backrest(A) into Chair Base(D), Firmly but gently.

Note: Make sure the Insert of Chair Backrest(A) locked into the Chair Base(D) in right position. During this assembly process - do exercise caution. You may need to use your hand to press down and or pave away the padded surface to facilitate the 'slip and slide' assembly.

Caution: Ensure that your fingers do not get caught or pinched in the assembly process.

Step 8

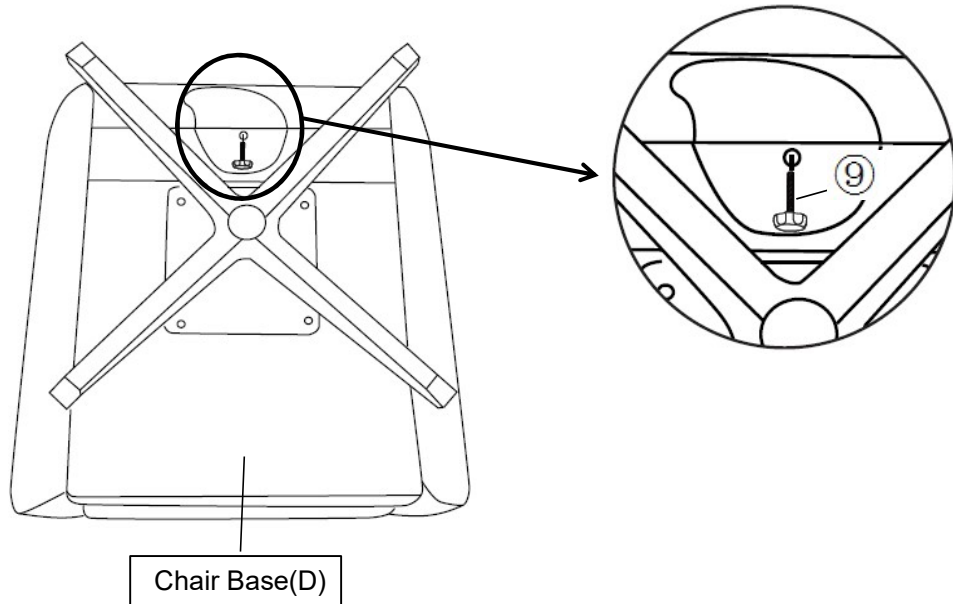





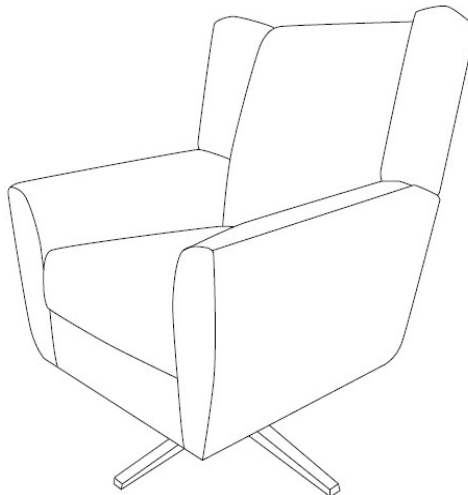





Turn over the Chair Base(D) bottom up as shown,tighten by turning the Bolt(9) clockwise until tight.
Then position the Chair right side up.

Step 9



Your Swivel Chair is ready for use.
This Swivel Chair can only be used on a flat, level surface.

Care & Maintenance

- ✓  • Furniture may scratch floors. We recommend using furniture pads to protect your floors.
- ⊘  • Do not put hot items directly on furniture surface.
- ⊘  • Do not clean furniture with harsh cleansers or polish.
- ⊘  • Do not place furniture under direct sunlight.
- ⊘  • Do not place furniture near heating or cooling vents.
- ⊘  • Do not write on furniture without a padded barrier to protect the surface.
- ⊘  • Do not place furniture outside . For indoor use only.
- ⊘  • Not for commercial use. For residential use only.
- ⊘  • Stains may be removed with mild soap solution and damp cloth.
- ⊘  • Children should not climb or jump on the furniture.
- ✓  • Dust and pick-up spills using a clean, non-colored, lint-free cloth.