

NOTICE







- * Please make sure that you have all parts indicated and they are in good condition before you begin assembly of this item. Refer to part list and hardware list below for guidance.
- * This item should be assembled on a soft surface to prevent scratching the finish during assembly.
- * This item may require periodic tightening.
- * If you are having difficulty, our friendly Customer Care team is always here to help. Please email customersupport@safavieh.com

PREPARATION

- * Before beginning assembly of product, make sure all parts are present. Compare parts with part contents list and hardware contents list.
- * If any part is missing or damaged, do not attempt to assemble the product.
- * Estimated Assembly Time: 10 minutes.
- * Tools Required for Assembly (included): Allen Key

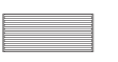
CARE AND MAINTENANCE

* Always use felt pads under all articles to prevent discoloration or softening of the lacquer. Plastic and rubber bases on items can discolor wood. Wipe up spills immediately and avoid common hazards such as hot dishes, harsh solvents and abrasives. Cleaning should be done with a soft lint free cotton cloth dampened with water or furniture polish. On highly used surfaces we recommend applying a quality paste wax which should be used on a regular basis to provide additional protection from scratches and spills. How often you apply the wax depends on how much wear the furniture receives.

| Part List and Hardware List | | | |
|-----------------------------|----------------------------------|---|----------|
| PIECE | DESCRIPTION | PICTURE | QUANTITY |
| A | Side frame |  | 1X |
| B | Side frame |  | 1X |
| C | Shelf |  | 4X |
| D | Stick |  | 4X |
| HW1 | Hex socket screws(M3 x 1 x 25MM) |  | 24X |
| HW2 | Allen key |  | 1X |



Model# STG1905A

Product Dimensions: 30.04"W X 12.99"D X 29.13"H

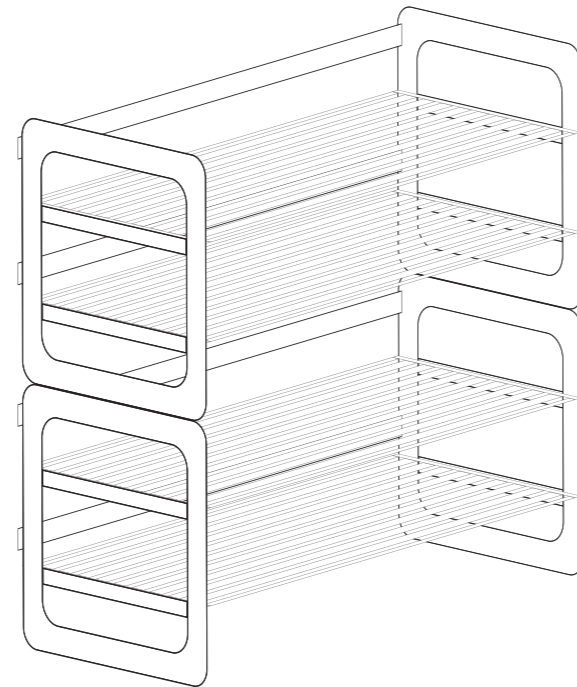

⚠ WARNING ⚠

Weight Capacity - 10 lbs of each shelf
 Warning: Do not stand on product
 Warning: Do not over torque bolts.

PREPARATION

- * Before beginning assembly of product, make sure all parts are present. Compare parts with part contents list and hardware contents list.
- * If any part is missing or damaged, do not attempt to assemble the product.
- * Estimated Assembly Time: 10 minutes.
- * Tools Required for Assembly (included): Allen Key
- * If you are having difficulty, our friendly Customer Care team is always here to help. Please email customersupport@safavieh.com

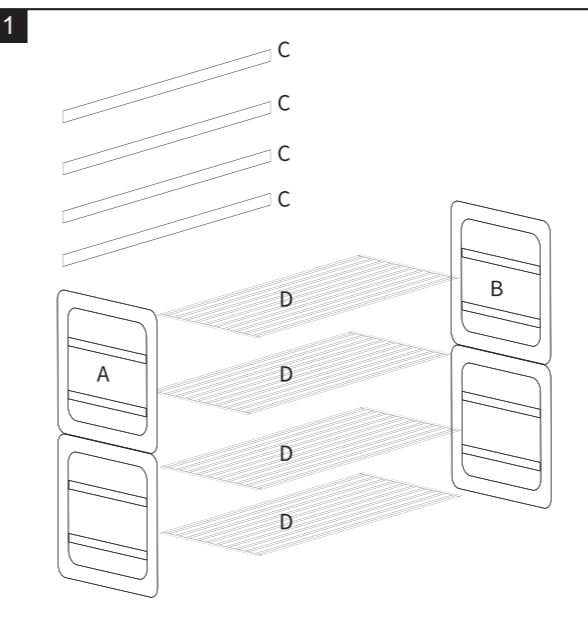
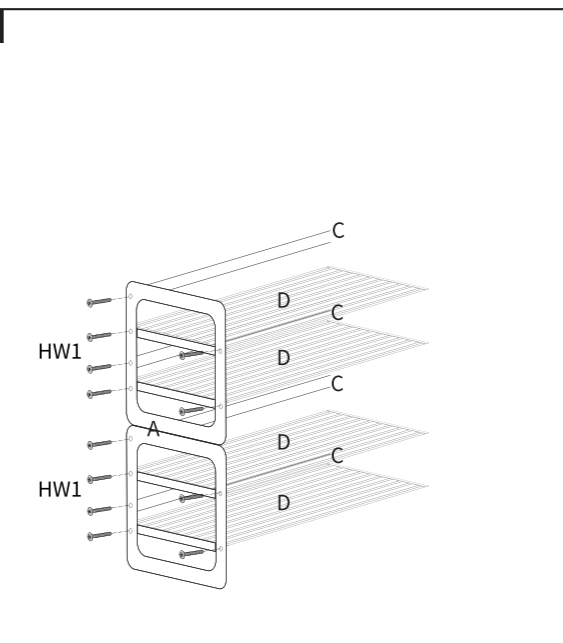
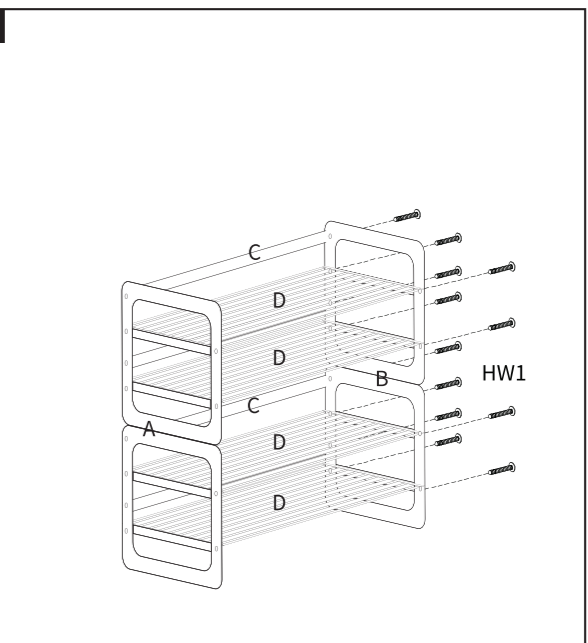
| | | |
|--|---|---|
| <p>1</p>  | <p>2</p>  <p>* Do not fully tighten screws until the product is assembled.</p> | <p>3</p>  <p>* After properly adjusting the levelers for stability, then fully tighten all screws.</p> |
| <p>Step1: Find the corresponding parts as the picture showed</p> | <p>Step2: Fix shelf (B) & stick (C) to one side frame (A) using (HW1)Hex socket screws</p> | <p>Step3: Fix the other side frame(B) to the assembled part using (HW1) Hex socket screws</p> |