

- EN** - Please read this instruction manual carefully before attempting to install.
- DE** - Bitte lesen Sie diese Bedienungsanleitung vor der Montage gründlich durch.
- ES** - Por favor lea con atención el manual de instrucciones antes de llevar a cabo el ensamble.
- FR** - Lisez attentivement cette notice avant de commencer le montage.
- IT** - Si prega di consultare il libretto delle istruzioni prima del montaggio.

IMPORTANT/WICHTIG/ATENCIÓN

IMPORTANT/IMPORTANTE



EN - We recommend **1** or more people to install.
DE - Wir empfehlen, dass die Montage von **1** oder mehreren Personen durchgeführt werden sollte.
ES - Recomendamos realizar el ensamble con **1** o más personas.
FR - Il est recommandé d'effectuer le montage à **1** personne(s) ou plus.
IT - È necessaria la presenza di **1** o più persone per il montaggio di questo prodotto.



EN - The expected assembly time is **1 h**.
DE - Die Montagezeit beträgt durchschnittlich **1 h**.
ES - El tiempo aproximado de ensamble es de **1 h**.
FR - Le temps nécessaire est estimé à **1 h**.
IT - Il tempo previsto per il corretto assemblaggio è di **1 h**.



EN - Not intended for use by children.
DE - Nicht geeignet für Kinder.
ES - Producto no apto para niños.
FR - Produit non destiné à être utilisé par des enfants.
IT - Questo prodotto non è destinato all'uso da parte dei bambini.









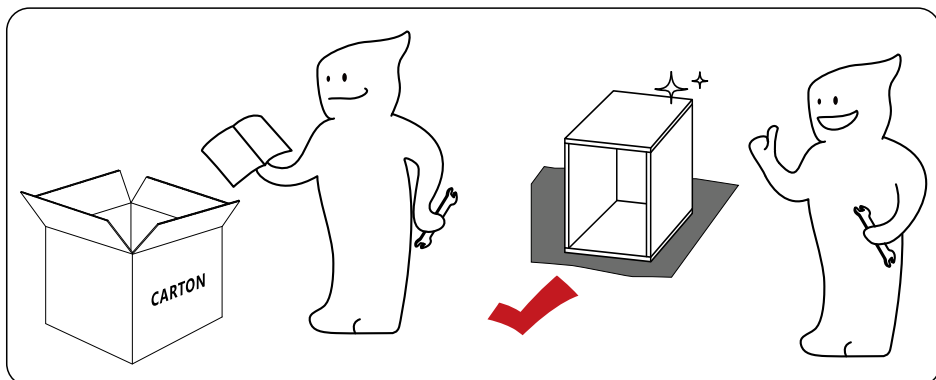
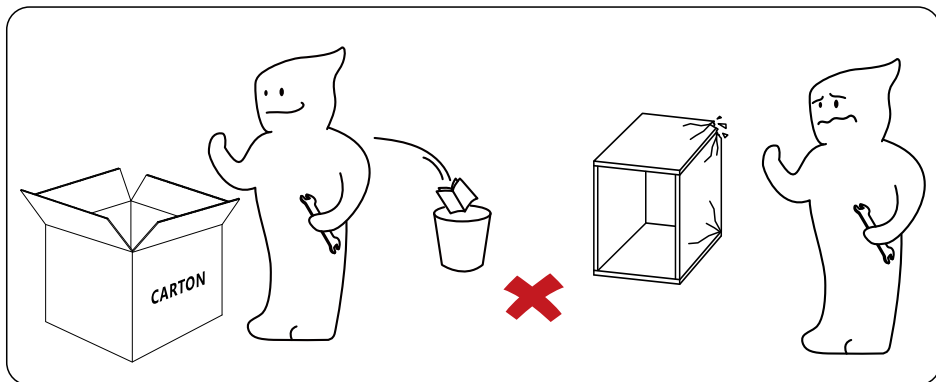

EN - Keep away from fire or other heat sources.
DE - Bitte von Feuer und Hitzequellen fernhalten.
ES - Manténgase alejado de las llamas y otras fuentes de calor.
FR - Tenir à distance des flammes et autres sources de chaleur.
IT - Tenere lontano dal fuoco o da altre fonti di calore.

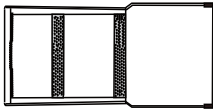
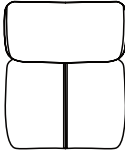
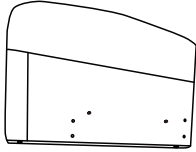
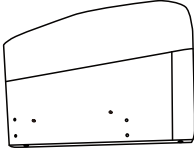
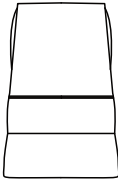

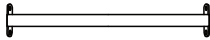
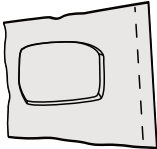
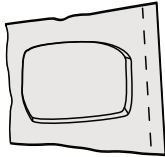
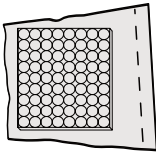
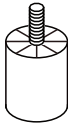

EN - We recommend wearing protective gloves.
DE - Wir empfehlen das Tragen von Schutzhandschuhen.
ES - Recomendamos el uso de guantes de seguridad.
FR - Il est recommandé de porter des gants de protection.
IT - Per il processo di assemblaggio, consigliamo fortemente l'utilizzo di guanti protettivi.

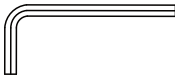
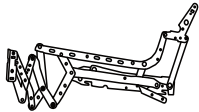
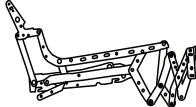
- EN** - Please follow the instruction manuals and use a pad to avoid damage during assembly.
- DE** - Bitte folgen Sie der Anleitung und verwenden Sie eine Unterlage, um Beschädigungen bei der Montage zu vermeiden.
- ES** - Por favor, siga las instrucciones del manual y utilice una cubierta o lona para proteger el producto y el suelo durante la instalación.
- FR** - Suivez les instructions de la notice et utilisez une couverture ou une bâche pour protéger le produit et les sols pendant le montage.
- IT** - Si prega di consultare il manuale illustrativo durante il montaggio e di utilizzare un cuscinetto per evitare possibili danni.



<p>(A) x 1</p> 	<p>(B) x 1</p> 	<p>(C) x 1 Left</p> 	
<p>(D) x 1 Right</p> 	<p>(E) x 1</p> 	<p>(F) x 1</p> 	
<p>(G) x 2</p> 	<p>(H) x 1</p> 	<p>(I) x 1</p> 	
<p>(J) x 1</p> 	<p>(K) x 4</p> 	<p>(L) x 4</p> 	<p>(M) x 4</p>  <p>15mm</p>
<p>(N) x 12</p>  <p>20mm</p>	<p>(O) x 4</p>  <p>40mm</p>	<p>(P) x 1</p> 	<p>(Q) x 1 Left</p> 
<p>(R) x 1 Right</p> 	<p>(S) x 2</p> 	<p>(T) x 2</p> 	

1

(H)		x1
(I)		x1
(J)		x1

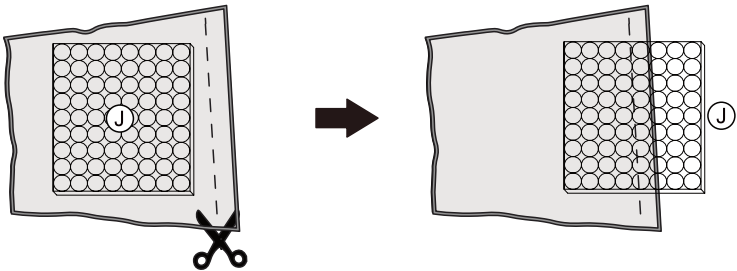
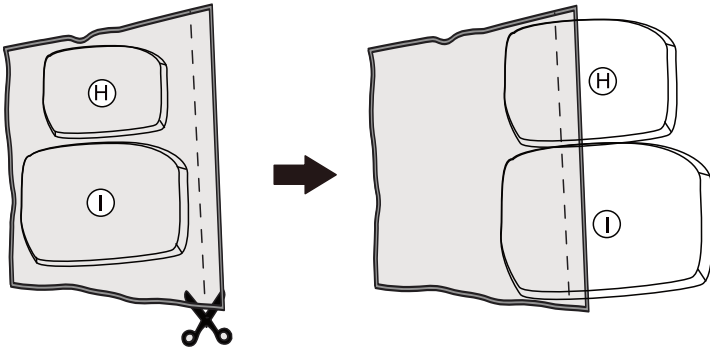
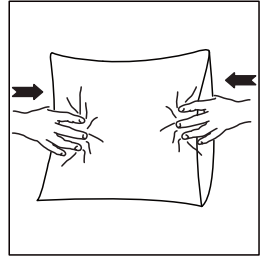
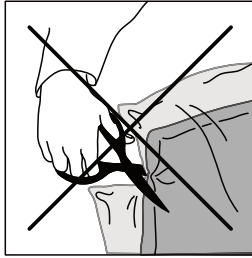

2

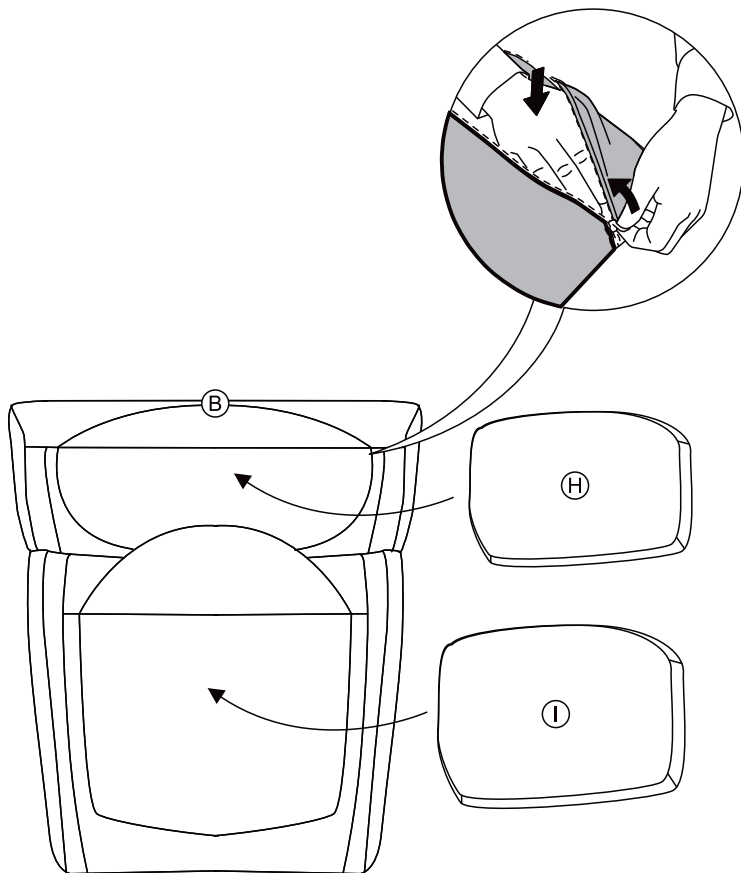
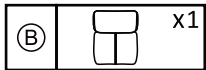

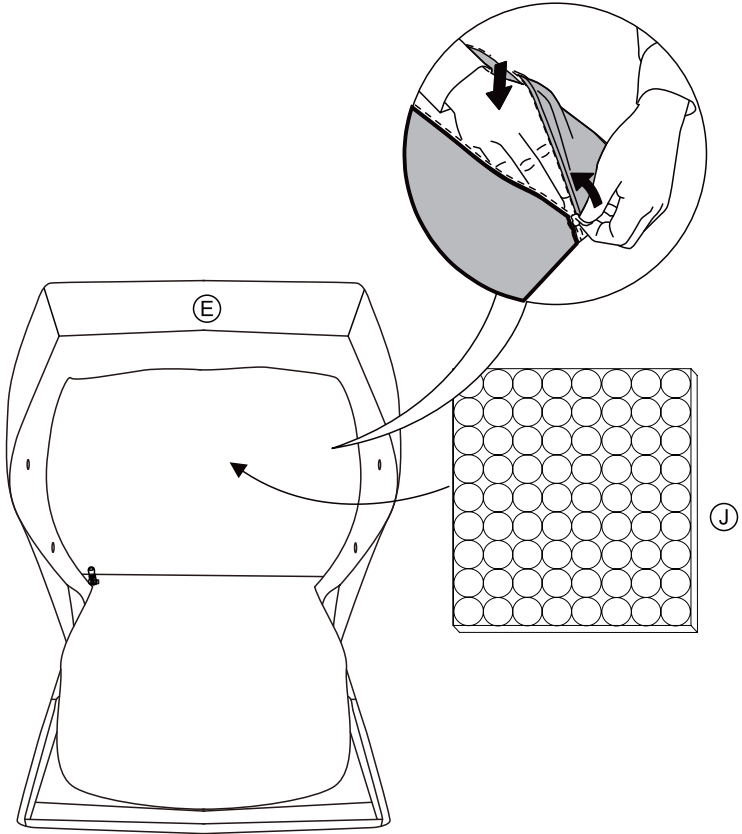
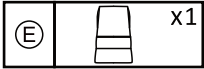

3

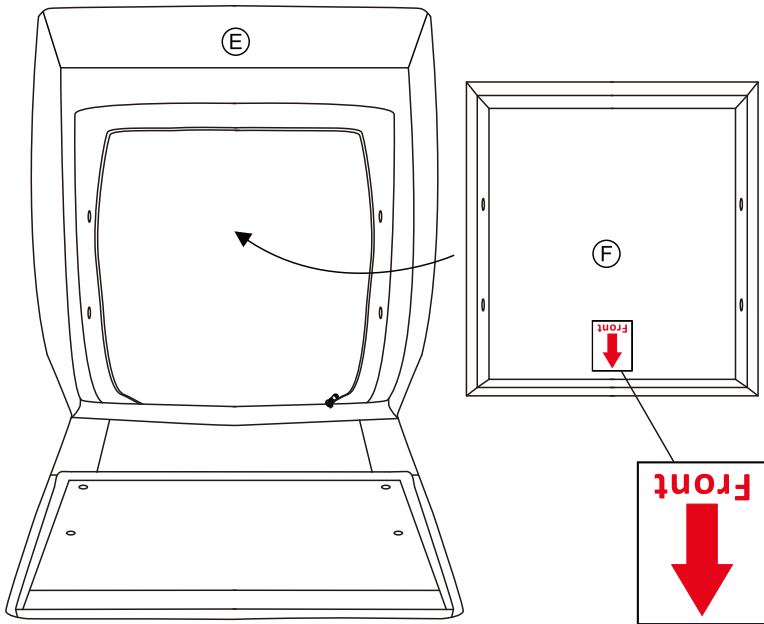
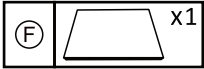

4



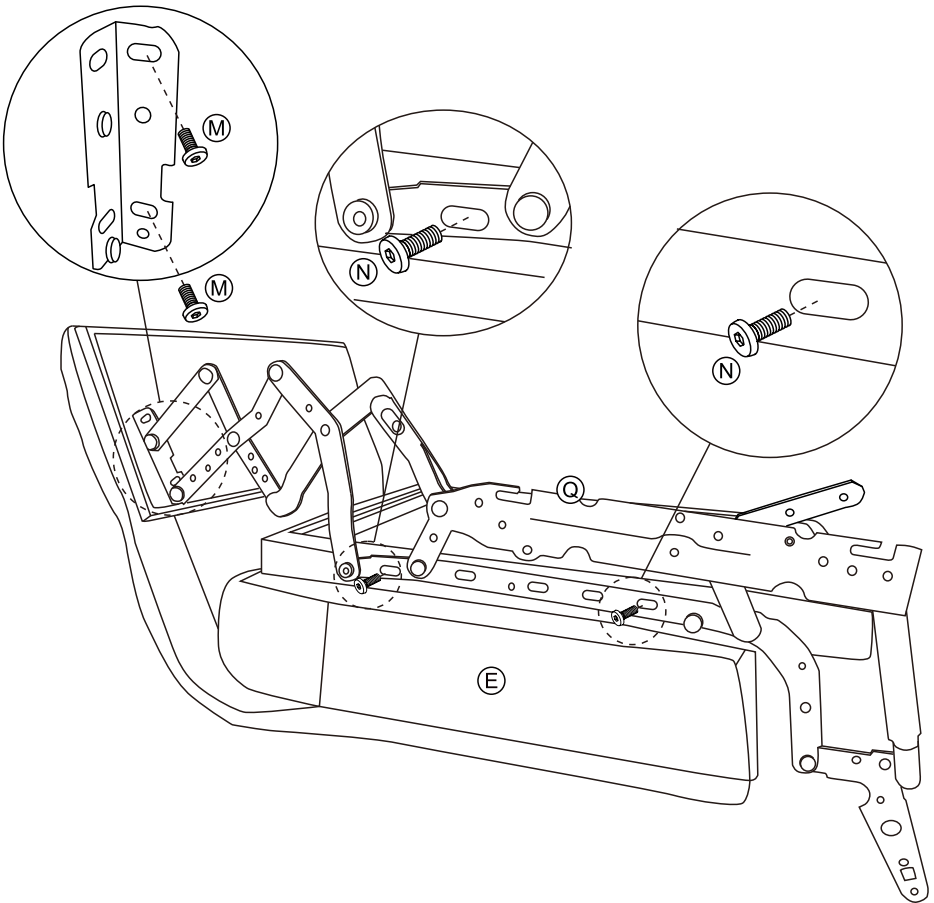

5

(M)		x2
(N)		x2
(Q)		x1





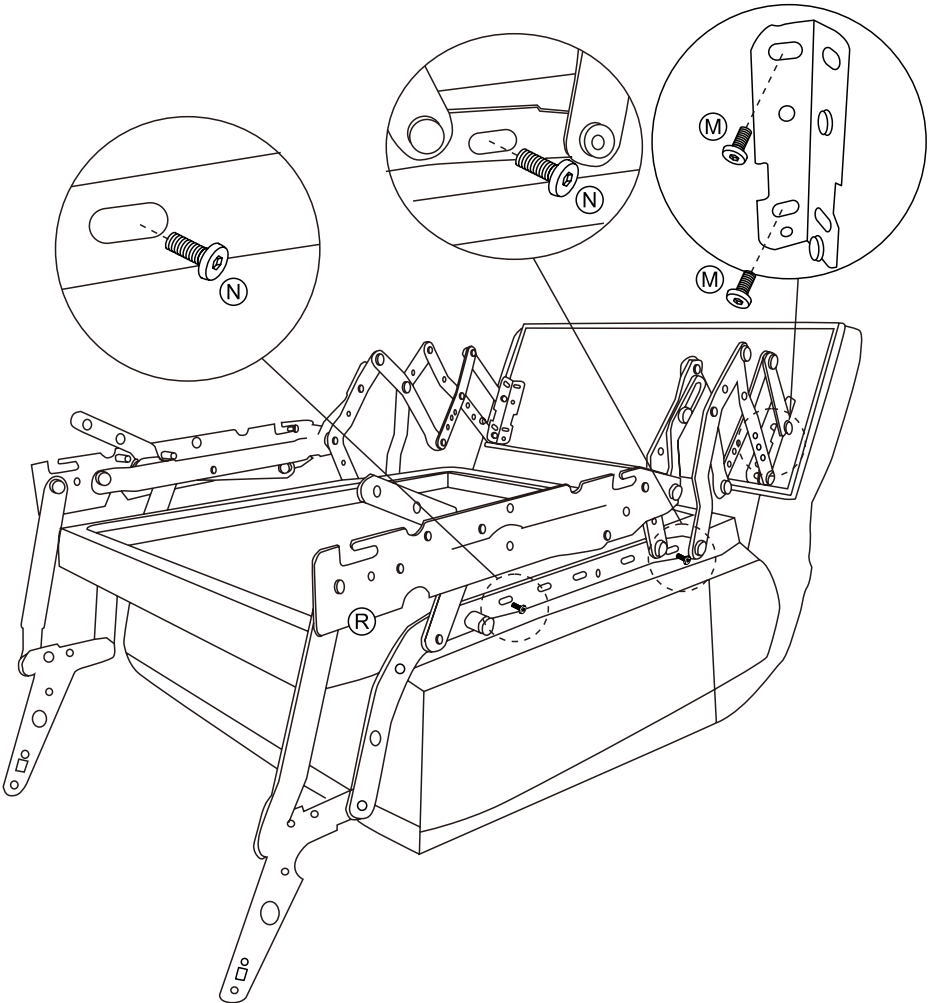

6

(M)		x2
(N)		x2
(R)		x1



7

Ⓒ		x1
Ⓓ		x1
Ⓞ		x4



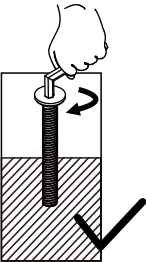

EN - Half tighten the screw
DE - Bitte die Schraube nur halb festziehen
ES - Apretar el tornillo a la mitad
FR - Ne serrez la vis que jusqu'à la moitié
IT - Stringere la vite a metà

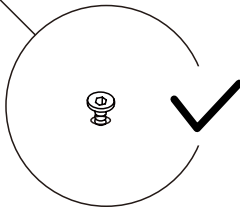
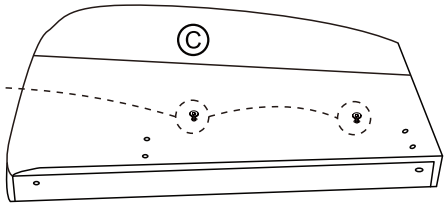
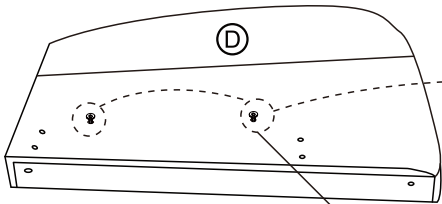
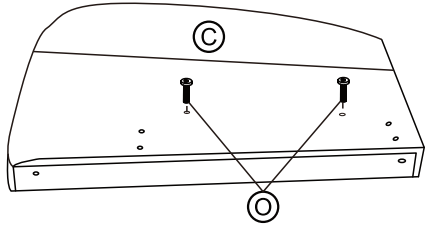
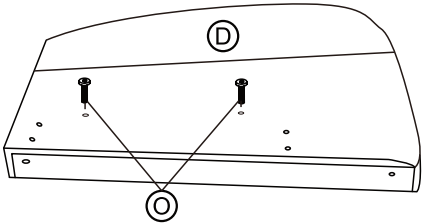

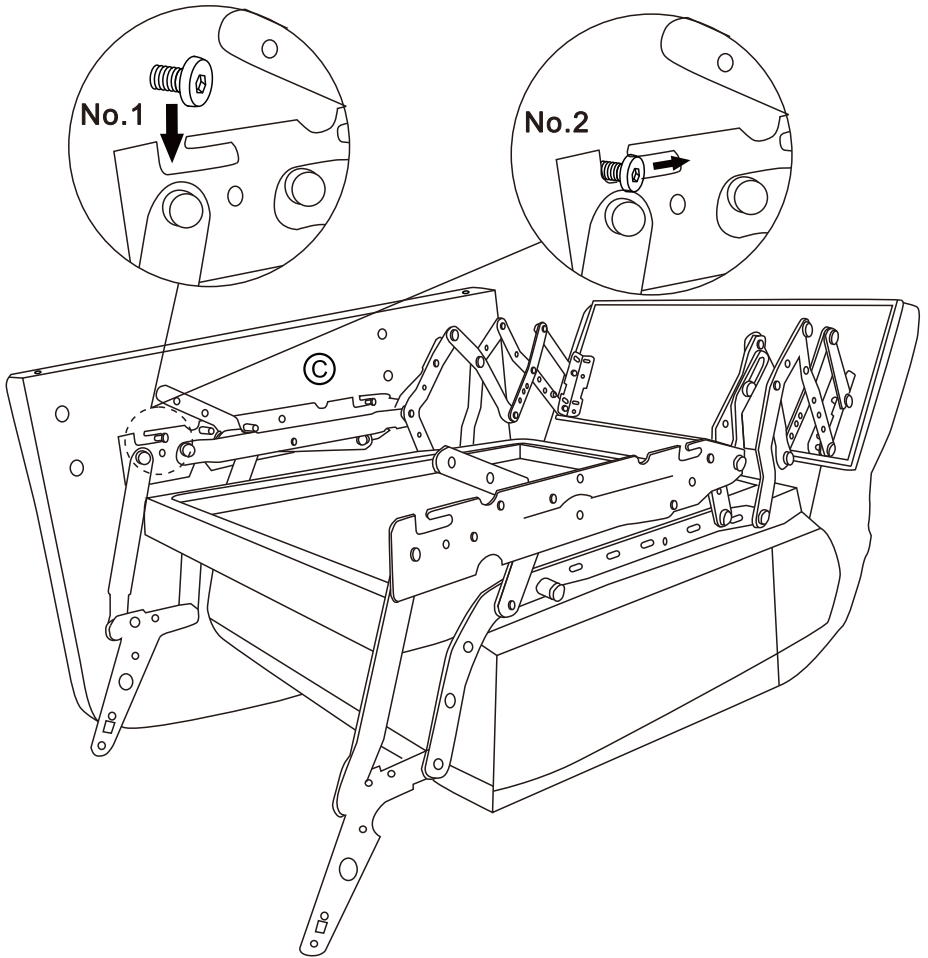

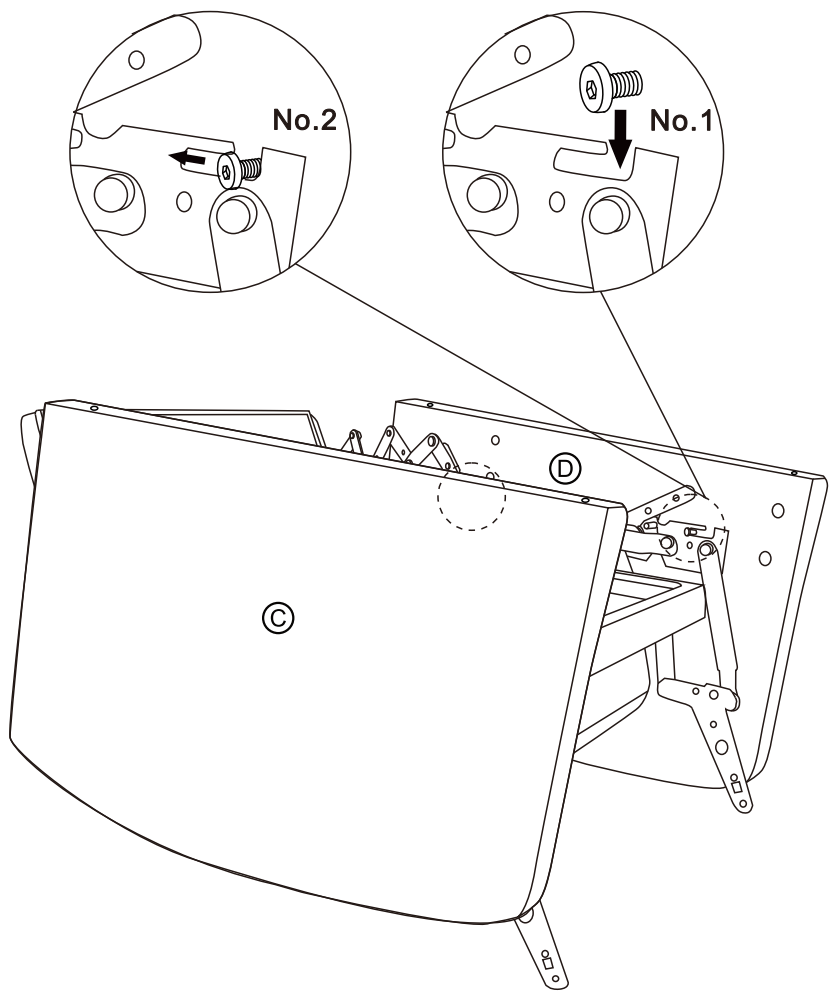

10

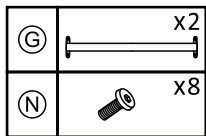

- EN** - During the assembly, please first half-tighten all the screws into the holes. After all the screws are set, fully tighten them.
- DE** - Bitte alle Schrauben leicht von Hand eindrehen, erst nachdem alle eingedreht sind, die Schrauben dann vollständig mit dem Inbuschlüssel festziehen.
- ES** - Durante el montaje, apriete todos los tornillos sólo hasta la mitad. después de insertar todos los tornillos, apriételes completamente.
- FR** - Pendant le montage, il est recommandé de ne serrer les vis qu'à demi. Ne vissez à fond qu'une fois toutes les vis insérées.
- IT** - Durante il montaggio, si prega di stringere tutte le viti solo a metà. Solamente dopo aver inserito tutte le viti, stringerle completamente.



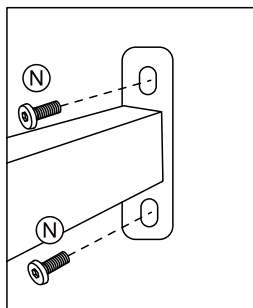

No.1

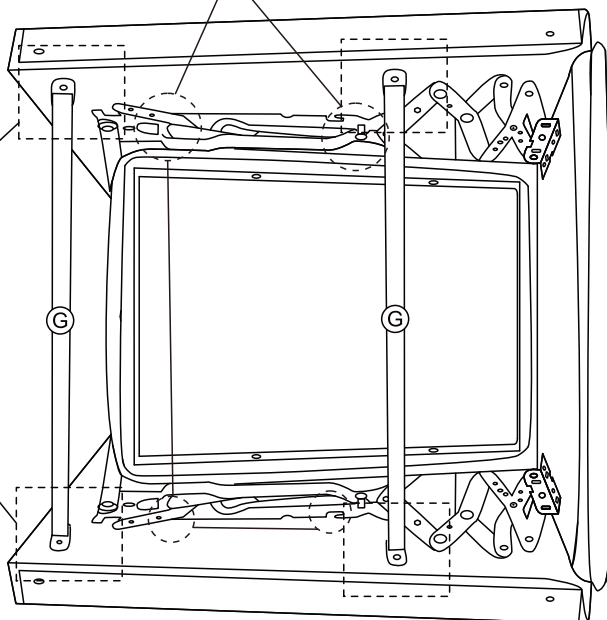
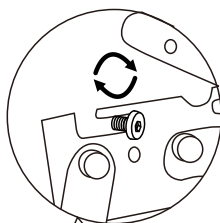

No.2



11

(K)		x4
(L)		x4
(S)		x2
(T)		x2

EN - Note: Tighten all screws completely after assembly.

DE - Hinweis: Ziehen Sie nach der Montage alle Schrauben vollständig an.

ES - Nota: Apretar completamente todos los tornillos después de montar.

FR - NB : Serrez les vis complètement après l'assemblage.

IT - Nota: Stringere completamente tutte le viti solo dopo l'assemblaggio.

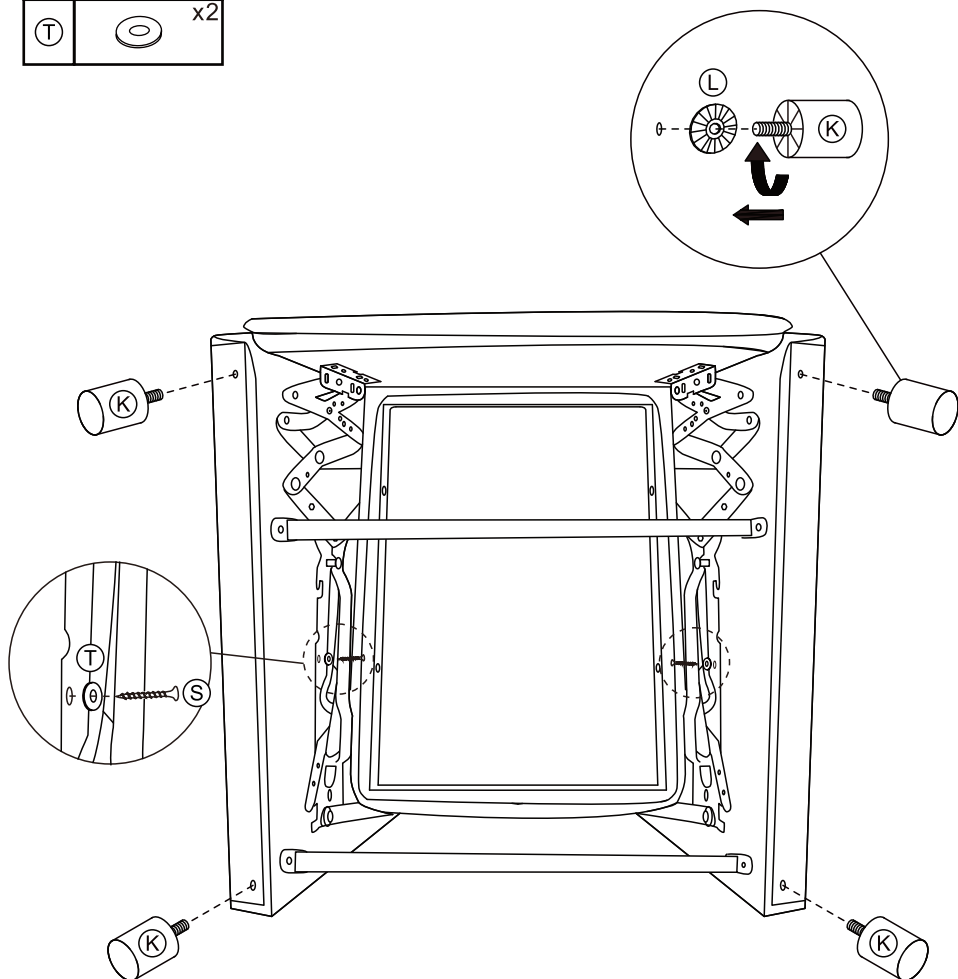

12

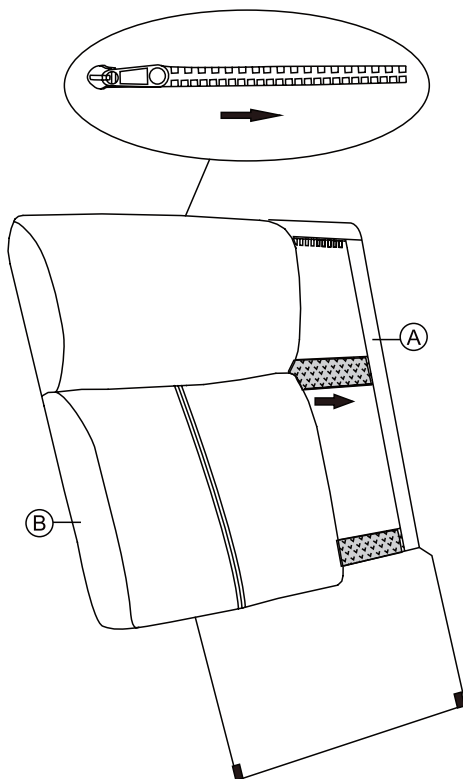

EN - Note: When installing (A), please separate the hook & loop fasteners underneath to use.



DE - Beim Einbau der (A) bitte die an der Unterseite liegenden Klettverschlüsse trennen.

ES - Nota: Cuando coloque los (A), por favor separe los sujetadores de gancho debajo para poder usarlos.

FR - Remarque: En installant les (A), veuillez séparer les attaches auto-agrippantes en dessous pour les utiliser.

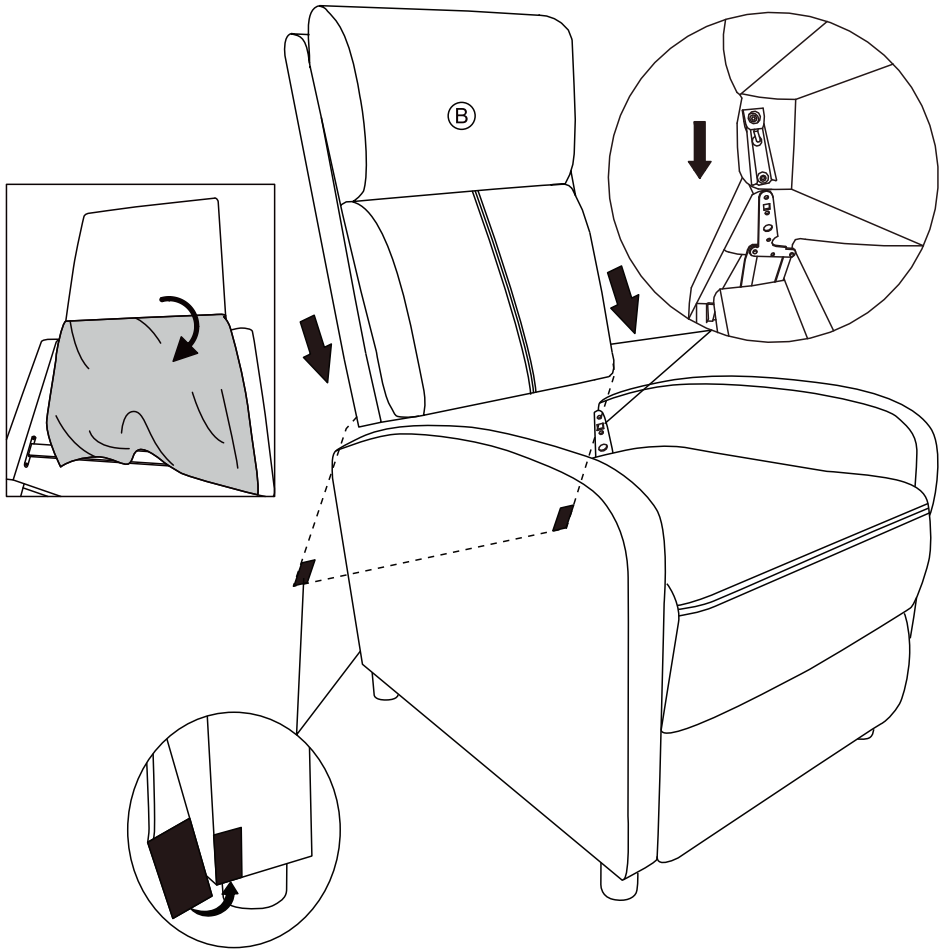
IT - Nota: Durante il montaggio (A), si prega di separare in basso il gancio e la chiusura.



	<p>EN - Velvet Vacuum your piece monthly to keep the velvet looking like new. Use a nylon brush to remove any dirt or food. Contact a professional annually for a deep clean.</p> <p>DE - Samt Reinigen Sie den Samtbezug regelmäßig mit dem Staubsauger. Um größeren Schmutz zu entfernen, verwenden Sie bitte eine weiche Nylonbürste. Für eine Intensivreinigung empfehlen wir, einen professionellen Reinigungsdienst zu beauftragen.</p> <p>ES - Piel Aspire la pieza mensualmente para mantenerla como nueva. Utilice un cepillo de nylon para eliminar cualquier suciedad o comida. Póngase en contacto con un profesional anualmente para una limpieza profunda.</p> <p>FR - Velours Passez l'aspirateur sur le velours une fois par mois pour qu'il conserve l'aspect du neuf. Utilisez une brosse à textiles pour retirer la poussière ou les restes alimentaires. Faites effectuer une fois par an un nettoyage professionnel.</p> <p>IT - Velluto Passa l'aspirapolvere ogni mese per mantenere il velluto come nuovo. Usa una spazzola in nylon per rimuovere lo sporco. Rivolgiti alle agenzie di pulizia professionali per una pulizia profonda una volta l'anno.</p>
	<p>EN - Stubborn Stains Blot stains with a damp cloth and a dash of dish soap. Wipe away excess water with a clean towel. Let the material air-dry fully before use.</p> <p>DE - Hartnäckige Flecken Entfernen Sie Flecken vorsichtig mit einem feuchten Tuch und wenig Spülmittel. Überschüssiges Wasser zügig mit einem sauberen Handtuch abwischen. Und nach der Reinigung das Material gut trocknen lassen.</p> <p>ES - Manchas persistentes Remueva las manchas con un paño húmedo y una pizca de jabón para platos. Limpie el exceso de agua con una toalla limpia. Deje que el material se seque completamente al aire libre antes de utilizarlo.</p> <p>FR - Taches tenaces Tamponnez les taches avec un chiffon humide et un peu de liquide vaisselle. Essuyez l'excès d'eau avec un tissu propre. Laissez sécher complètement à l'air avant réutilisation.</p> <p>IT - Macchie resistenti Pulisci la macchia con un panno umido e un goccio di detersivo lavapiatti. Asciuga l'acqua in eccesso tramite un panno asciutto. Lascia che il materiale si asciughi completamente all'aria aperta prima dell'utilizzo.</p>

**EN - Additional Tips**

Vacuum to remove any loose crumbs or dirt.
Have a pet? Use a lint roller to gather up any fur.

DE - Zusätzliche Tipps:

Lose Krümmel, Schmutz oder Staub durch einfaches staubsaugen entfernen.
Haustierhaare können einfach mit Hilfe einer Fusselrolle entfernt werden.

ES - Extra tips

Aspire para eliminar las migas sueltas o la suciedad.
Tiene mascota? utilice un rodillo para pelusas para remover los cabellos.

FR - Autres conseils

Retirez à l'aide d'un aspirateur les miettes et saletés.
Si vous avez un animal, utilisez un rouleau anti-peluche pour ramasser les poils.

IT - Suggestimenti

Passa l'aspirapolvere per rimuovere ogni briciola rimasta o polvere.
Hai animali domestici? Usa una spazzola adesiva per raccogliere tutti i peli.

EN - Preventative Care

Potate pillows and cushions monthly to ensure even wear.
Avoid placing your piece in direct sunlight to prevent fading.
Add a slipcover. Most are machine-washable and can change up your style!

DE - Vorbeugende Pflege

Durch regelmäßiges Wenden der Kissen und Polster können Sie eine vorzeitige Abnutzung vermeiden.
Vermeiden Sie, ihr Möbelstück direkter Sonneneinwirkung auszusetzen. Dies verhindert ein Ausbleichen des Stoffes.
Ein passender Schutzbezug verhindert starke Verschmutzung, ist zudem meist maschinenwaschbar und auch geeignet um den Stil zu verändern!

ES - Cuidados preventivos

Rote las almohadas y los cojines mensualmente para asegurar un desgaste uniforme.
Evite colocar sus piezas bajo la luz directa del sol para evitar el deterioro.
Utilice una funda para cubrir. Las fundas pueden ser lavadas con máquina y pueden cambiar su estilo.

FR - Soins préventifs

Retournez les coussins une fois par mois pour une usure uniforme.
N'exposez pas votre produit à la lumière directe du soleil afin d'éviter une décoloration.
Ajoutez une housse: la plupart sont lavables en machine et vous permettent de changer de style.

IT - Prevenzione

Gira i cuscini mensilmente per evitare maggiore usura.
Si prega di evitare di porre il prodotto sotto la luce del sole, in modo da evitarne lo sbiadimento.
Aggiungi una fodera. La maggior parte delle fodere sono lavabili in lavatrici e possono migliorare il vostro stile.

-
- EN** - You can also download the electronic Installation Manual from the Product guides and documents section of the advertising page.
- DE** - Das elektronische Installationshandbuch können Sie auch im Bereich Produktführungen und Dokumente der Werbeseite herunterladen.
- ES** - También puede descargar el Manual de instalación electrónica de la Guía del producto y la Sección de documentación de la página de anuncios.
- FR** - Vous pouvez également télécharger le manuel d'installation électronique à partir de la section Guide produit et documentation de la page publicitaire.
- IT** - È inoltre possibile scaricare il manuale di installazione elettronico dalla guida del prodotto e dai documenti nella pagina pubblicitaria.