

Garsing

Outdoor Leisure

Garsing 8'x5' grill gazebo

Assembly Manual

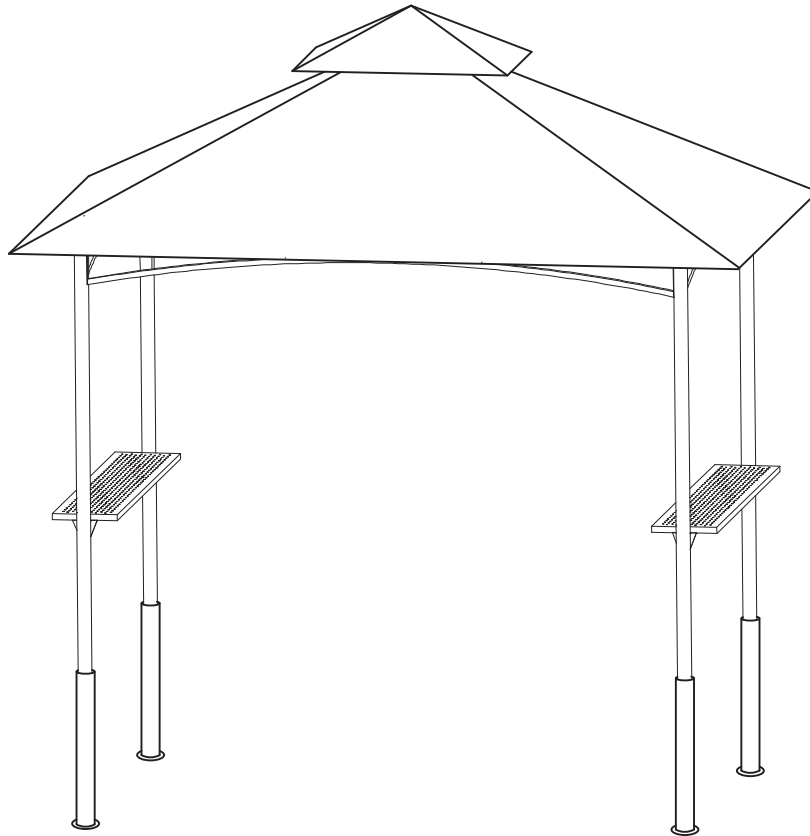

Brand concept

Garsing, a top manufacturer and good designer, has decades of experience in manufacturing patio products. Each piece is sleekly designed, rigorously tested for durability, and assembly instructions have been standardized for simplicity from start to finish. Garsing always looks forward to creating a freedom lifestyle for more people, and more opportunities to explore the unknown and explore the value of life! Garsing hopes your leisure time delightful and comfortable by providing more patio products with reliable craftsmanship and durable material and 24 Hours service.

Our Service

30-day money back guarantee.
90-day warranty for quality-related issue with free replacement.
24 Hours Online Customer Service FOR YOU!
Reminder: Be sure to use your product as directed.
WhatsApp: 0086-13905747420
EMAIL: servicefunsite@gmail.com

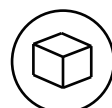

Order Status

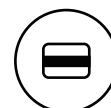

Installation Help











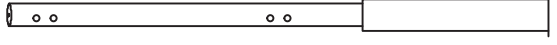



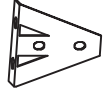

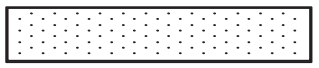
Gift Cards

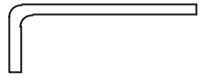
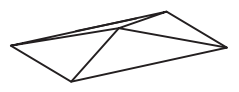
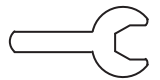
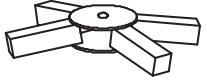
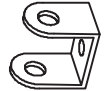

New Product Discount

Parts List

A	2PCS	
A1	2PCS	
B	2PCS	
B1	2PCS	
C	4PCS	
D	4PCS	
F	1PC	
F1	1PC	
L	48PCS	
N	8PCS	
P	1PC	
Q	2PCS	
E	1PC	
G	4PCS	
I	40PCS	 M6×15
J	4PCS	 M6×30
M	4PCS	
O	1PC	
S	1PC	

Maintenance

Please read and follow all safety statements, warnings, assembly instructions, use and care directions before attempting to assemble.

1. When installing and assembling your gazebo, it is recommended that 2 or more adults are involved.
2. Do not use the unit during an electrical storm, as there is a remote chance of getting struck by lightning.
3. Do not climb on top of the gazebo. Falling off the gazebo can result in serious injury, possibly even death.
4. Do not leave the gazebo assembled when there is a risk of high wind, as damage may occur to the structure.
5. This package contains small items and plastic bags that should be kept away from children.
6. Ensure that all connectors & poles are firmly secured in position fully. It is important to do so before use so as to avoid collapsing or damage to the item, which could result in injury.

WARNING: Keep flame and heat sources away from the gazebo fabric. The fabric may burn if it is exposed to prolonged contact with a source of heat. The application of any foreign substance to the gazebo fabric may render the flame-resistant properties ineffective.

WARNING: Please take down the gazebo during strong wind. The manufacturer or retailer is not liable for any loss of the product or other items due to the failure to take down the gazebo during strong wind.

Tools required: Stepladder and Screwdriver (not included).

Set-up Instruction

- ① Screw the Bolt (I) through washer (L) and part (G) into Pole (A/A1)
Don't be screwed too tight.(Part G can be rotate to match the gazebo top frame)

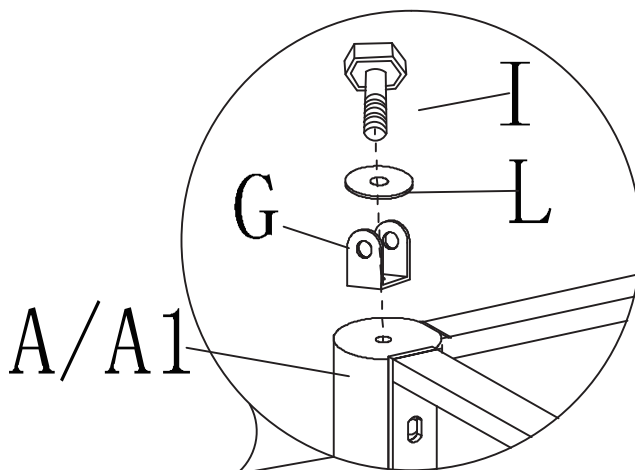

- ② Attach the Long Screen (B) and Short Screen (B1) to pole A (A1) with bolt (I) and washer(L)

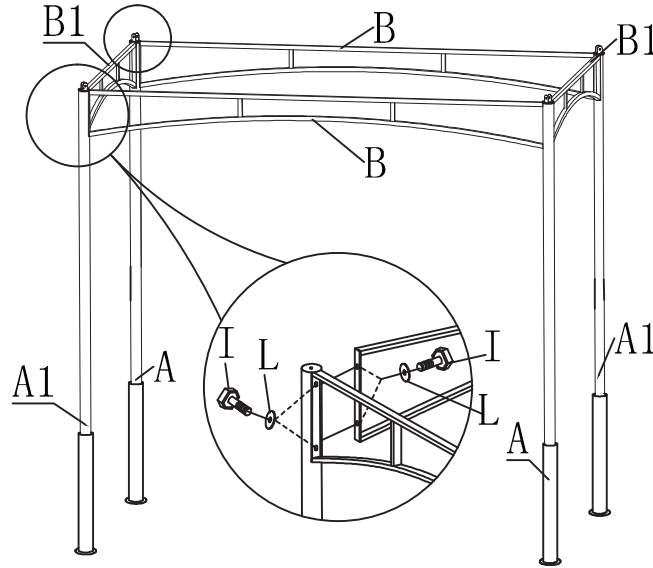

- ③ Insert Corner top beam (C) into Big Top Connector (E)

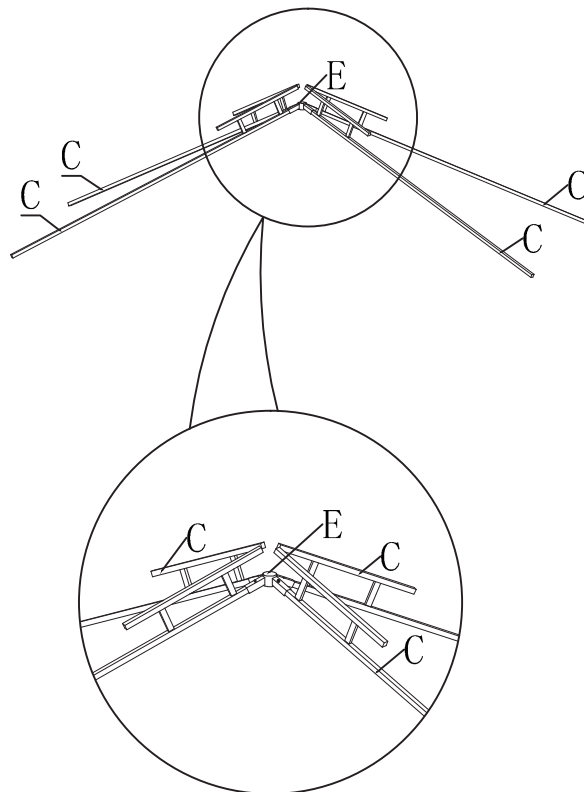

4

Put the top beam frame to part G, then fix the top beam frame to main fram with bolt (J) ,washer (L) and nut (M) .

Caution: Please use a sturdy stepladder.

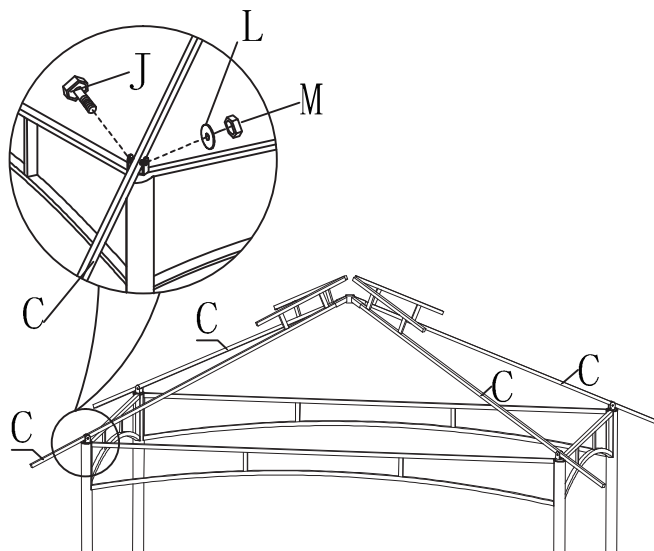

5

Begin by attaching top canopy (P) , then install the main canopy (O) .

Caution: please use a sturdy stepladder.

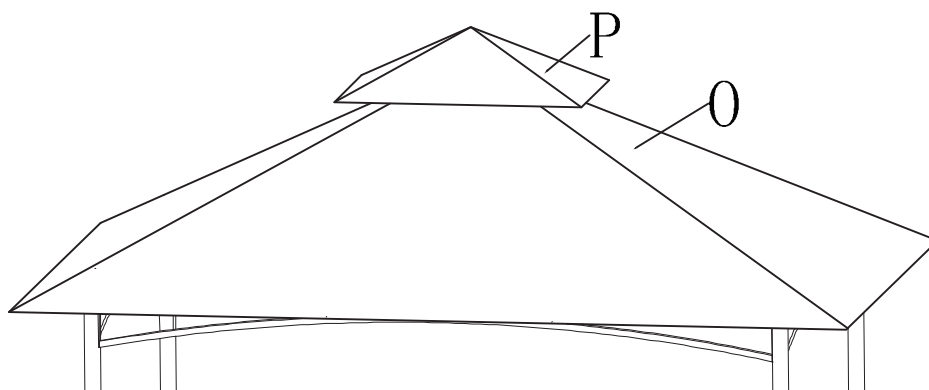

6

Attach hook rack (S) to shelf (F) with bolt (I) and washer (L)

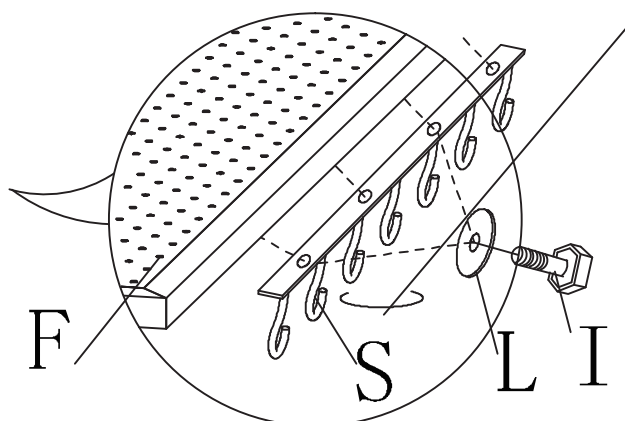

⑦ Attach part (D) to shelves (F/F1) with bolt(J) and washer(L)

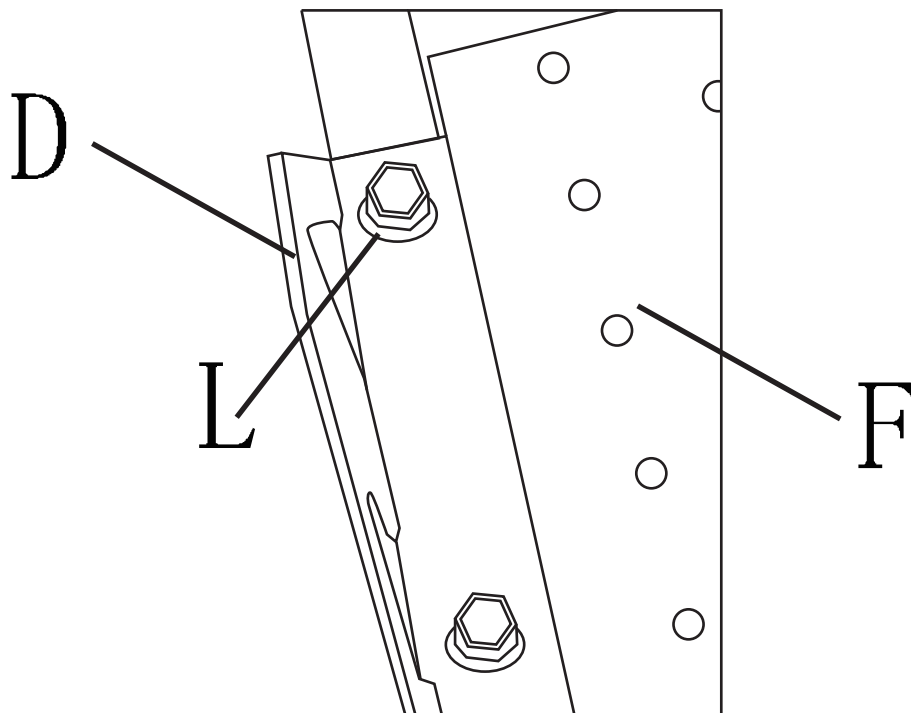

⑧ Fix shelves (F/F1) to the pole (A/A1)

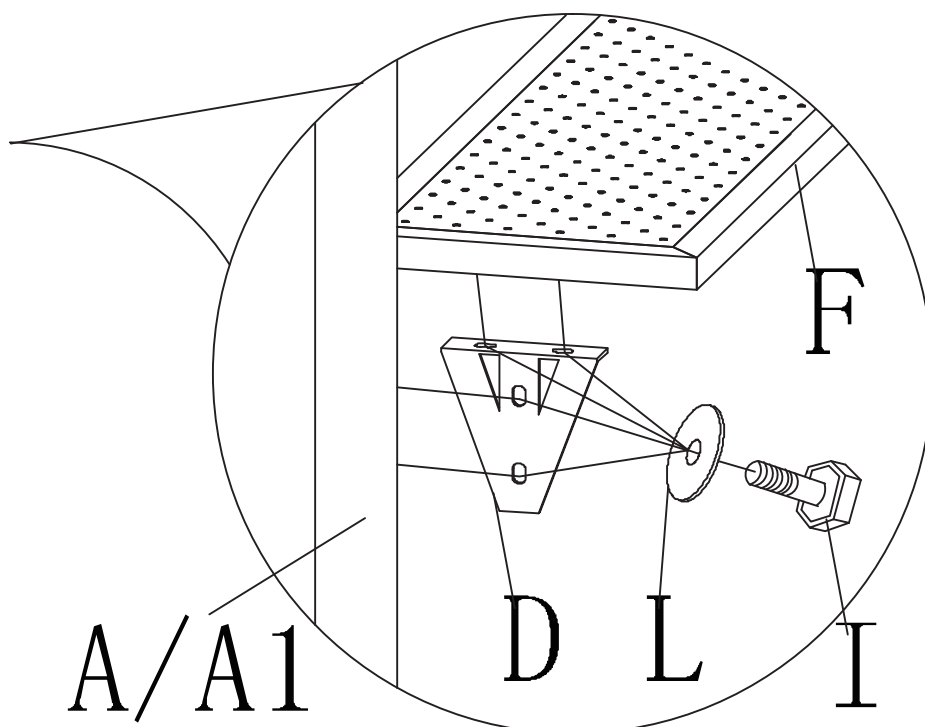

- ⑨ Fix the grill gazebo into ground by using steel pegs(N)

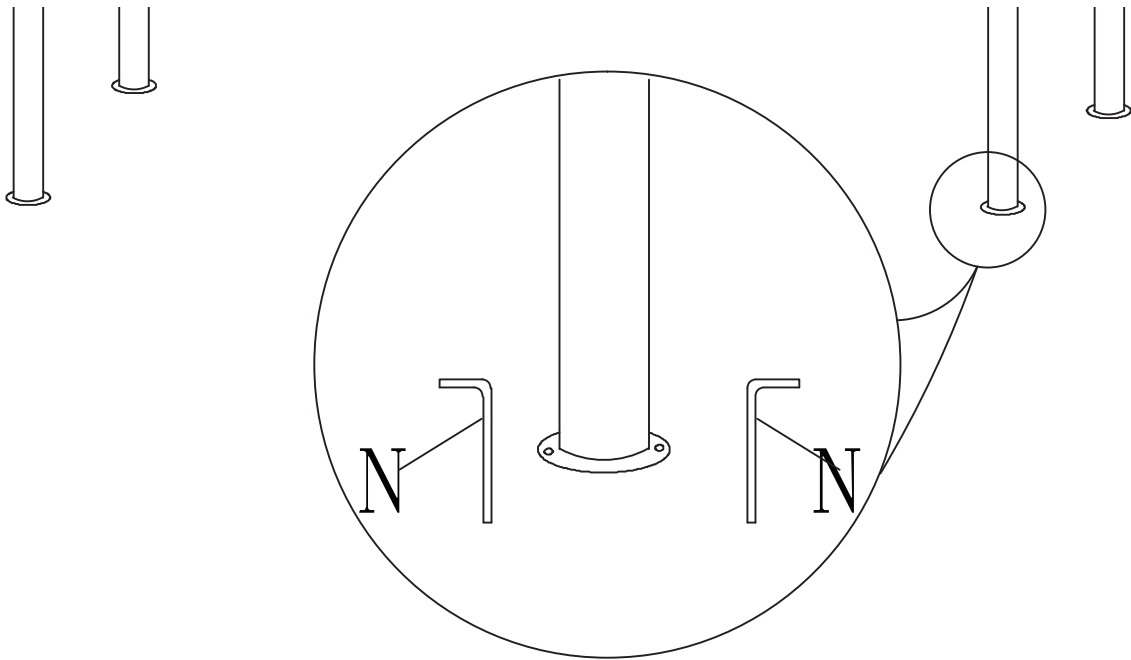

Use & Care

- 1.This gazebo is not a permanent structure and should be disassembled & stored away after use
- 2.Do not repack your gazebo until completely dry
- 3.This gazebo must be assembled by two adults or more
- 4.If windy conditions exist , please disassemble the gazebo