

Induction Cooktop

Instruction Manual / Installation Manual

MODEL:

EMPV-36EC01

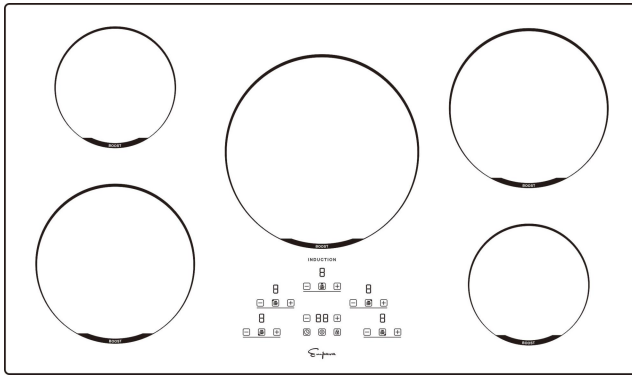

EMPV-30EC02

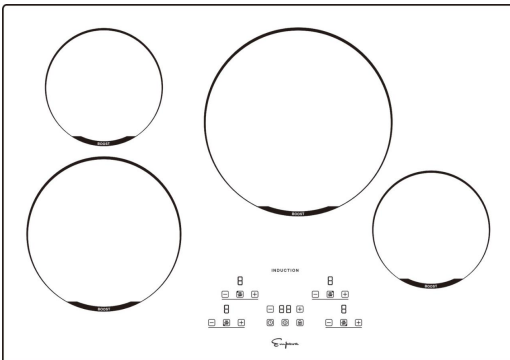

EMPV-24EC03

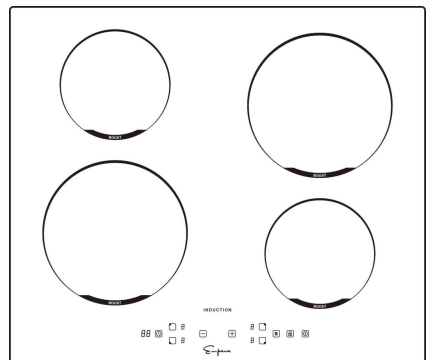

IMPORTANT INSTRUCTION

PLEASE READ THE FOLLOWING INSTRUCTIONS CAREFULLY BEFORE USING THE APPLIANCE.

- 1) Proper Installation – Be sure your appliance is properly installed and grounded by a qualified technician.
- 2) Never Use Your Appliance for Warming or Heating the Room.
- 3) Do Not Leave Children Alone – Children should not be left alone or unattended in area where appliance is in use. They should never be allowed to sit or stand on any part of the appliance.
- 4) Wear Proper Apparel – Loose-fitting or hanging garments should never be worn while using the appliance.
- 5) User Servicing – Do not repair or replace any part of the appliance unless specifically recommended in the manual. All other servicing should be referred to a qualified technician.
- 6) Storage in or on Appliance – Flammable materials should not be stored in an oven or near surface units.
- 7) Do Not Use Water on Grease Fires – Smother fire or flame or use dry chemical or foam-type extinguisher.
- 8) Use Only Dry Potholders – Moist or damp potholders on hot surfaces may result in burns from steam. Do not let potholder touch hot heating elements. Do not use a towel or other bulky cloth.
- 9) Use Proper Pan Size – This appliance is equipped with one or more surface units of different size. Select utensils having flat bottoms large enough to cover the surface unit heating element. The use of undersized utensils will expose a portion of the heating element to direct contact and may result in ignition of clothing. Proper relationship of utensil to burner will also improve efficiency.
- 10) Never Leave Surface Units Unattended at High Heat Settings – Boil-over causes smoking and greasy spillovers that may ignite.
- 11) Make Sure Reflector Pans or Drip Bowls Are in Place – Absence of these pans or bowls during cooking may subject wiring or components underneath to damage.
- 12) Protective Liners – Do not use aluminum foil to line surface unit drip bowls or oven bottoms, except as suggested in the manual. Improper installation of these

liners may result in a risk of electric shock, or fire.

13) Utensil Handles Should Be Turned Inward and Not Extend Over Adjacent Surface Units – To reduce the risk of burns, ignition of flammable materials, and spillage due to unintentional contact with the utensil, the handle of a utensil should be positioned so that it is turned inward, and does not extend over adjacent surface units.

14) Do Not Cook on Broken Cook-Top – If cook-top should break, cleaning solutions and spillovers may penetrate the broken cook-top and create a risk of electric shock. Contact a qualified technician immediately.

15) Clean Cook-Top With Caution – If a wet sponge or cloth is used to wipe spills on a hot cooking area, be careful to avoid steam burn. Some cleaners can produce noxious fumes if applied to a hot surface.

16) Do not place metallic objects such as knives, forks, spoons and lids on the cooktop surface since they can get hot.

17) CAUTION: Do not store items of interest to children in cabinets above a range or on the backguard of a range – children climbing on the range to reach items could be seriously injured.

18) DO NOT TOUCH SURFACE UNITS OR AREAS NEAR UNITS – Surface units may be hot even though they are dark in color. Areas near surface units may become hot enough to cause burns. During and after use, do not touch, or let clothing or other flammable materials contact surface units or areas near units until they have had sufficient time to cool. Among these areas are (identification of areas – for example, the cook-top and surfaces facing the cook-top).

19) CAUTION – Light (Error Code) signals a component failure. Disconnect power supply and call qualified serviceman. Have appliance repaired by a qualified serviceman before using.

20) Read these instructions carefully before installing or using this appliance.

21) No combustible material or products should be placed on this appliance at any time.

22) Please make this information available to the person responsible for installing the appliance as it could reduce your installation costs.

23) In order to avoid a hazard, this appliance must be installed according to

these instructions for installation.

24) This appliance is to be properly installed and earthed only by a suitably qualified person.

25) This appliance should be connected to a circuit which incorporates an isolating switch providing full disconnection from the power supply.

26) **WARNING:** Use only cooktop guards designed by the manufacturer of the cooking appliance or indicated by the manufacturer of the appliance in the instructions for use as suitable or cooktop guards incorporated in the appliance.

27) The use of inappropriate guards can cause accidents.

28) Failure to install the appliance correctly could invalidate any warranty or liability claims.

29) Regarding the details of installation, please refer to the section <Installation>.

30) Connect only to a 3-wire, 240-volt power supply; the neutral conductor is not required for the operation of the appliance. The potential at the power supply electrical connections shall be 150-volts-to-ground or less.

Electrical Shock Hazard

- Do not cook on a broken or cracked cooktop. If the cooktop surface is broken or cracked, switch the appliance off immediately at the mains power supply (wall switch) and contact a qualified technician.
- Switch the cooktop off at the wall before cleaning or maintenance.
- Failure to follow this advice may result in electrical shock or death.

Health Hazard

- This appliance complies with electromagnetic safety standards.

Hot Surface Hazard

- During use, accessible parts of this appliance will

become hot enough to cause burns.

- Do not let your body, clothing or any item other than suitable cookware contact the ceramic glass until the surface is cool.
- Metallic objects such as knives, forks, spoons and lids should not be placed on the cooktop surface since they can get hot.
- Children less than 8 years of age shall be kept away unless continuously supervised.
- Handles of saucepans may be hot to touch. Check saucepan handles do not overhang other cooking zones that are on. Keep handles out of reach of children.
- Failure to follow this advice could result in burns and scalds.

Cut Hazard

- The razor-sharp blade of a cooktop scraper is exposed when the safety cover is retracted. Use with extreme care and always store safely and out of reach of children.
- Failure to use caution could result in injury or cuts.

Safety instructions

- Never leave the appliance unattended when in use. Boilover causes smoking and greasy spillovers that may ignite.
- Never use your appliance as a work or storage surface.
- Never leave any objects or utensils on the appliance.
- Never use your appliance for warming or heating the room.
- After use, always turn off the cooking zones and the cooktop as described in this manual (i.e. by using the touch controls).
- Do not allow children to play with the appliance or sit,

stand, or climb on it.

- Do not store items of interest to children in cabinets above the appliance. Children climbing on the cooktop could be seriously injured.
- Do not leave children alone or unattended in the area where the appliance is in use.
- Children or persons with a disability which limits their ability to use the appliance should have a responsible and competent person to instruct them in its use. The instructor should be satisfied that they can use the appliance without danger to themselves or their surroundings.
- Do not repair or replace any part of the appliance unless specifically recommended in the manual. All other servicing should be done by a qualified technician.
- Do not use a steam cleaner to clean your cooktop.
- Do not place or drop heavy objects on your cooktop.
- Do not stand on your cooktop.
- Do not use pans with jagged edges or drag pans across the glass surface as this can scratch the glass.
- Do not use scourers or any other harsh abrasive cleaning agents to clean your cooktop, as these can scratch the ceramic glass.
- If the supply cord is damaged, it must be replaced by the manufacturer, its service agent or similarly qualified persons in order to avoid a hazard.
- This appliance is intended to be used in a domestic household environment only! Commercial use of any kind is not covered under the manufacturer's warranty!

- **WARNING:** The appliance and its accessible parts become hot during use.
- Care should be taken to avoid touching heating elements.
- Children shall not play with the appliance. Cleaning and user maintenance shall not be made by children without supervision.
- **WARNING:** Unattended cooking on a cooktop with fat or oil can be dangerous and may result in fire. **NEVER** try to extinguish a fire with water, but switch off the appliance and then cover flame e.g. with a lid or a fire blanket.
- **WARNING:** Danger of fire: do not store items on the cooking surfaces.
- **WARNING:** If the surface is cracked, switch off the appliance to avoid the possibility of electric shock, for cooktop surfaces of glass-ceramic or similar material which protect live parts.
- A steam cleaner is not to be used.
- The appliance is not intended to be operated by means of an external timer or separate remote-control system.

SAVE THESE INSTRUCTIONS

Congratulations on the purchase of your new cooktop. We recommend that you spend some time to read this Instruction / Installation Manual in order to fully understand how to install correctly and operate it.

Read all the safety instructions carefully before use and keep this Instruction / Installation Manual for future reference.

Connecting the cooktop to the main power supply

The power supply should be connected in compliance with the relevant standard, or a single-pole circuit breaker. The method of connection is shown as below.

For 4-wire cable from home power supply

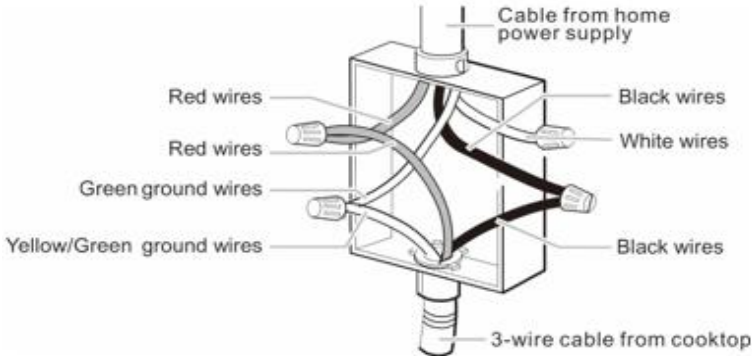

For 3-wire cable from home power supply

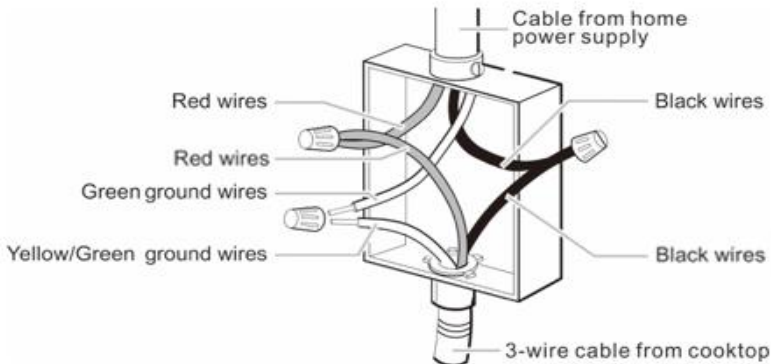

If the cable is damaged or needs replacing, this should be done by an after-sales technician using the proper tools, so as to avoid any accidents.

- If the appliance is being connected directly to the mains supply, an omnipolar circuit breaker must be installed with a minimum gap of 0.12in between the contacts.
- The installer must ensure that the correct electrical connection has been made and that it complies with safety regulations.
- The cable must not be bent or compressed.
- The cable must be checked regularly and only replaced by a proper qualified person.

Product Overview

Top View

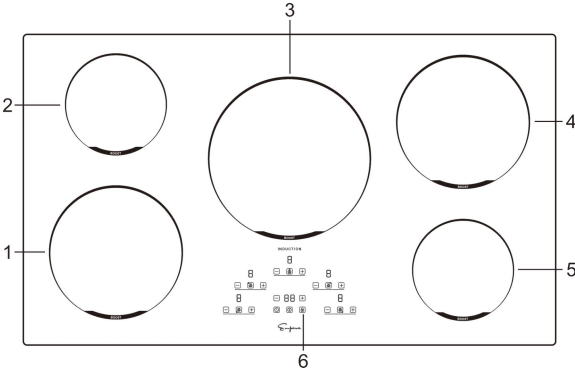

EMPV-36EC01

- 1. max. 1800/2100W zone
- 2. max. 1200/1500W zone
- 3. max. 2300/3700W zone
- 4. max. 1800/2100W zone
- 5. max. 1200/1500W zone
- 6. Control panel

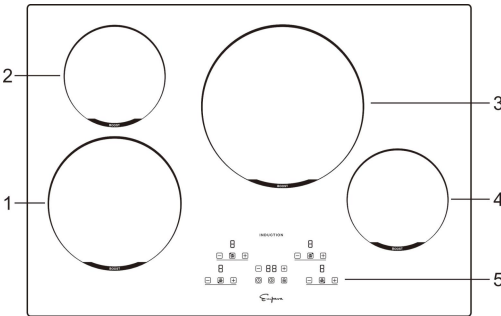

EMPV-30EC02

- 1. max. 1800/2100W zone
- 2. max. 1200/1500W zone
- 3. max. 2300/3700W zone
- 4. max. 1200/1500W zone
- 5. Control panel

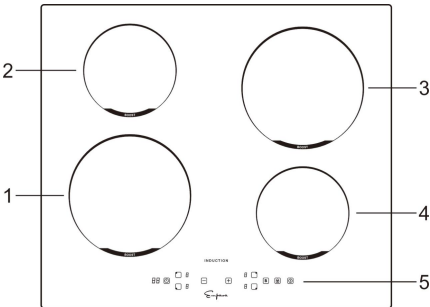

EMPV-24EC03

- 1. max. 2300/3000W zone
- 2. max. 1200/1500W zone
- 3. max. 1800/2100W zone
- 4. max. 1200/1500W zone
- 5. Control panel

The Control Panel

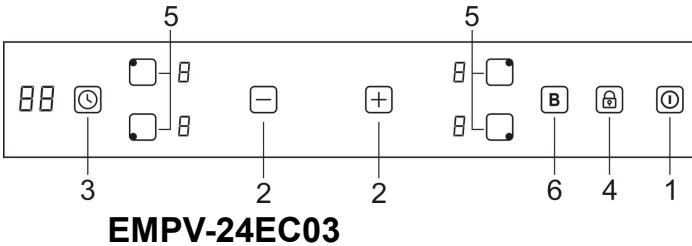
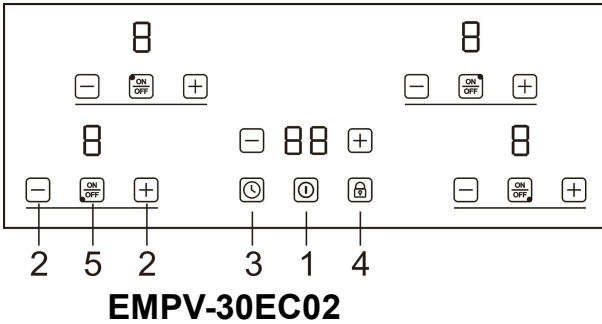
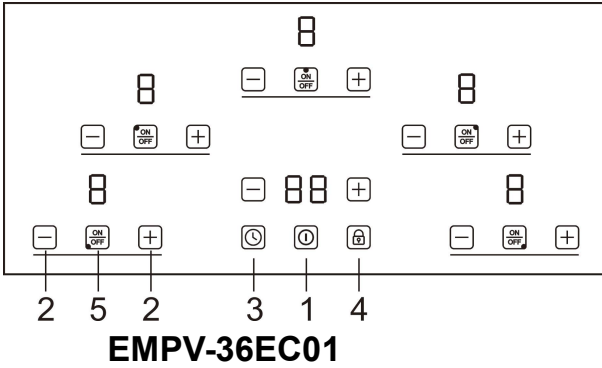

- | | |
|-----------------------|------------------|
| 1. ON/OFF switch | 4. Child lock |
| 2. Select power level | 5. Heating zone |
| 3. Setting the timer | 6. Boost control |

Product Information

The ceramic/induction cooktop can meet different kinds of cuisine demands because of resistance wire heating, micro-computerized control and multi-power selection, really the optimal choice for modern families.

The cooktop centers on customers and adopts personalized design. The cooktop has safe and reliable performances, making your life comfortable and enabling to fully enjoy the pleasure from life.

A Word on Induction Cooking

Induction cooking is a safe, advanced, efficient, and economical cooking technology. It works by electromagnetic vibrations generating heat directly in the pan, rather than indirectly through heating the glass surface. The glass becomes hot only because the pan eventually warms it up.

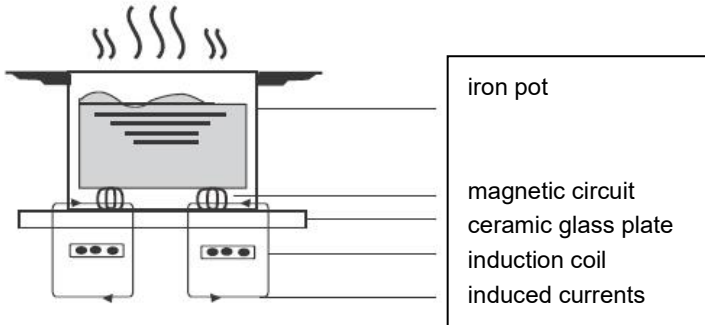

Before using your New Cooktop

- Read this guide, taking special note of the 'Safety Warnings' section.
- Remove any protective film that may still be on your ceramic cooktop.
- Remove any protective film that may still be on your Induction cooktop.

Using the Touch Controls

- The controls respond to touch, so you don't need to apply any pressure.
- Use the ball of your finger, not its tip.
- You will hear a beep each time a touch is registered.
- Make sure the controls are always clean, dry, and that there is no object (e.g. a utensil or a cloth) covering them. Even a thin film of water may make the controls difficult to operate.



Choosing the right Cookware

- Only use cookware with a base suitable for induction cooking. Look for the induction symbol on the packaging or on the bottom of the pan.
- You can check whether your cookware is suitable by carrying out a magnet test. Move a magnet towards the base of the pan. If it is attracted, the pan is suitable for induction.
- If you do not have a magnet:
 1. Put some water in the pan you want to check.
 2. Follow the steps under 'To start cooking'.
 3. If  does not flash in the display and the water heating, the pan is suitable.
- Cookware made by the following materials is not suitable: pure stainless steel, aluminum or copper without a magnetic base, glass, wood, porcelain, ceramic, and earthenware.

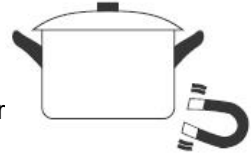

Size of burner (in)	The minimum cookware (diameter /in)
6.30	4.72
7.09	5.51
8.27	6.30
11.02	7.09

Do not use cookware with jagged edges or a curved base.



Make sure that the base of your pan is smooth, sits flat against the glass, and is the same size as the cooking zone. Always centre your pan on the cooking zone.

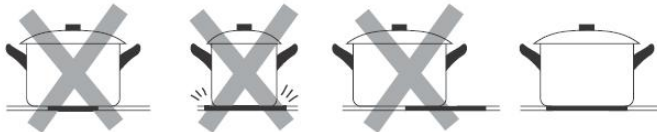

Always lift pans off the ceramic cooktop – do not slide, or they may scratch the glass.

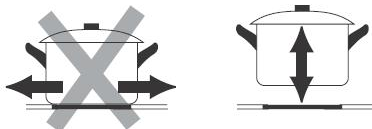

Using your Cooktop - EMPV-36EC01 / EMPV-30EC02

- After power on, the buzzer beeps once, all the indicators light up for 1 second then go out, indicating that the cooktop has entered the state of standby mode.

1. Touch the power ON/OFF  switch, the timer indicator show “—”.

2. Place a suitable pan on the cooking zone that you wish to use. Make sure the bottom of the pan and the surface of the cooking zone is clean and dry.

3. Touching the heating zone ON/OFF control, the heating zone indicator show “—”.

4. Select a heat setting by touching the “—” “+” control.

·If you don't choose a heat setting within 1 minute, the induction cooktop will automatically switch off. You will need to start again at step 1.

·You can modify the heat setting at any time during cooking.

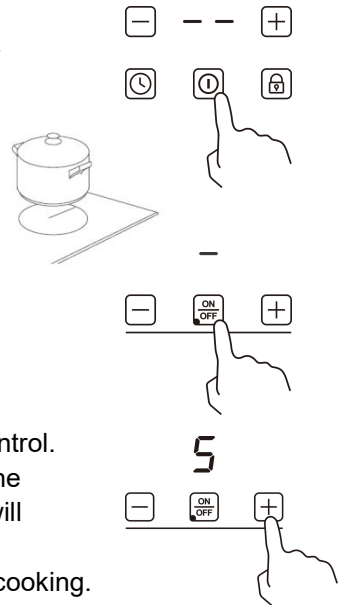

When you have finished cooking

1. Turn the single heating zone off by touching the heating zone ON/OFF control.

2. Turn the whole cooktop off by touching the power ON/OFF control.

3. Beware of hot surfaces

“H” will show which means cooking zone is too hot to touch. It will disappear when the surface has cooled down to a safe temperature. It can also be used as an energy saving function if you want to heat further pans, use the hotplate that is still hot.

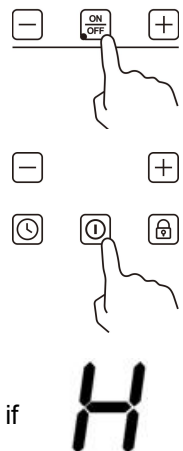

Using Boost function- EMPV-36EC01 / EMPV-30EC02

Activate the boost function

Touching the heating zone ON/OFF control and touching “+” until power level indication shows “P”.

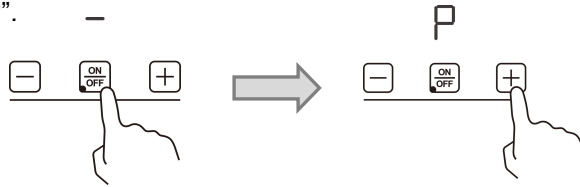

Cancel Boost function

Touching the “—” to cancel the Boost function, and select the level you want to set.

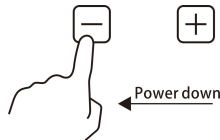

- Boost function can only last for 5 minutes, after that the zone will go to level 9 automatically.

Using your Cooktop - EMPV-24EC03

To start cooking

- After power on, the buzzer beeps once, all the indicators light up for 1 second then go out, indicating that the cooktop has entered the state of standby mode.

1. Touch the ON/OFF  switch. all the indicators show “—”

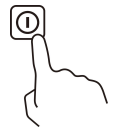

2. Place a suitable pan on the cooking zone that you wish to use. Make sure the bottom of the pan and the surface of the cooking zone is clean and dry.



3. Touching the heating zone selection control, and an indicator next to the key will flash.



4. Select a heat setting by touching the “-” “+” control.

- If you don't choose a heat setting within 1 minute, the induction cooktop will automatically switch off. You will need to start again at step 1.

- You can modify the heat setting at any time during cooking.



When you have finished cooking

1. Touching the heating zone selection that you wish to switch off.



2. Turn the cooking zone off by touching the “—” “+” control, make sure the display shows “0”.

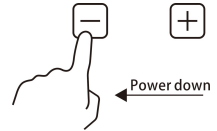

3. Turn the whole cooktop off by touching the ON/OFF control.

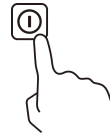

4. Beware of hot surfaces

“H” will show which means cooking zone is too hot to touch.

It will disappear when the surface has cooled down to a safe temperature. It can also be used as an energy saving function if you want to heat further pans, use the hotplate that is still hot.



Using Boost function - EMPV-24EC03

Activate the boost function

1. Select the zone with boost function (front left zone).

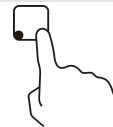

2. Touching **B** until power level indication shows “P”.

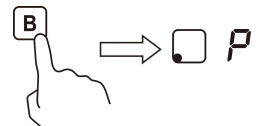

Cancel Boost function

1. Select the zone with boost function (front left zone).
2. Touching the “—” to cancel the Boost function, and select the level you want to set.

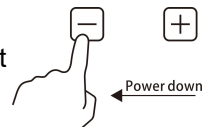

- Boost function can only last for 5 minutes, after that the zone will go to level 9 automatically.

Locking the Controls

- You can lock the controls to prevent unintended use (for example children accidentally turning the cooking zones on).
- When the controls are locked, all the controls except the ON/OFF control are disabled.

To lock the controls

Touch the keylock control, the timer indicator will show “Lo”.

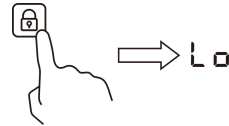

To unlock the controls

1. Make sure the cooktop is turned on.
2. Touch and hold the keylock control for 3 seconds.
3. You can now start using your cooktop.



When the cooktop is in lock mode, all the controls are disabling except the ON/OFF, you can always turn the cooktop off with the ON/OFF control in an emergency, but you shall unlock the cooktop first in the next operation.

Residual Heat Warning

When the cooktop has been operating for some time, there will be some residual heat. The letter “H” appears to warn you to keep away from it.

Auto Shutdown

Safety feature of the cooktop is auto shut down. This occurs whenever you forget to switch off a cooking zone. The default shutdown times are shown in the table below:

Power level	1	2	3	4	5	6	7	8	9
Default working timer (hour)	8	8	8	4	4	4	2	2	2

Using the Timer

You can use the timer in two different ways:

- You can use it as a minute minder. In this case, the timer will not turn any cooking zone off when the set time is up.
- You can use it as cut-off timer to turn one or more cooking zones off after time is up.
 - * You can set the timer up to 99 minutes.

Using the Timer as a Minute Minder

1. Make sure the cooktop is turned on. And zone selection key is not activated (zone indication ‘-’ is not blinking).

Note: you can set minute minder before or after cooking zone power setting finished.

2. Touch timer key, “00” will show in the timer display and “00” will blink.

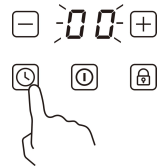

3. Set the time from 1~99 minutes by touching the “—” “+” control of the timer (e.g. 5)

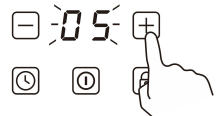

4. When the time is set, it will begin to count down immediately. The display will show the remaining time.

5. Buzzer will beeps for 30 seconds and the timer indicator shows “- -” when the setting time finished.



Using the timer to switch off one or more cooking zones

1. Touching the heating zone that you want to set the timer for and select the power level by touching the “—” “+”.

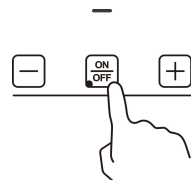

2. Touch timer control, the “00” will show in the timer display. and the “0” flash.

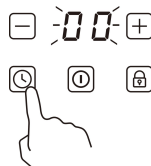

3. Set the time from 1~99 minutes by touching the “—” “+” control of the timer (e.g. 5)

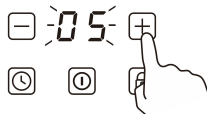

4. When the time is set, it will begin to count down immediately. The display will show the remaining time.



NOTE: There will be a red dot in the right bottom corner of power level indication which indicating that zone is selected.

5. When cooking timer expires, the corresponding cooking zone will be switched off automatically.

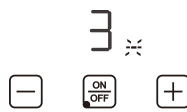

Note: Other cooking zones will keep operating if they are turned on previously.

If the timer is set on more than one zone:

1. When you set timer for several cooking zones, red dots of the relevant cooking zones are indicated. The timer display shows the min. timer. The dot of the corresponding zone blinks.

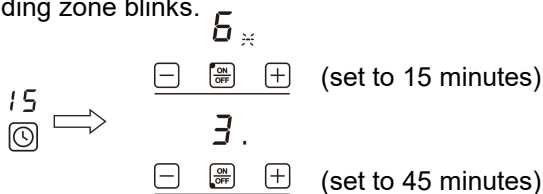

2. Once the countdown timer expires, the corresponding zone will switch off. Then it will show the new min. timer and the dot of corresponding zone will flash.

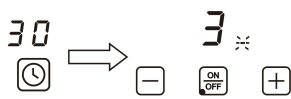

Note: Touch the heating zone selection control, the corresponding timer will be shown in the timer indicator.

Cancel the timer

1. Touching the “—” “+” control of heating zone that you want to cancel the timer.

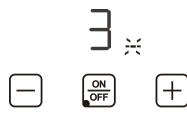

2. Touching the timer control, the indicator will flash.

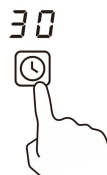

3. Touch the “—” “+” at the same time to set the timer to “00”, the timer is canceled.

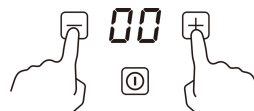

Cooking Guidelines

Take care when frying as the oil and fat heat up very quickly, particularly if you're using Boost. At extremely high temperatures oil and fat will ignite spontaneously and this presents a serious fire risk.

Cooking Tips

- When food comes to the boil, reduce the power setting.
- Using a lid will reduce cooking times and save energy by retaining the heat.
- Minimise the amount of liquid or fat to reduce cooking times.
- Start cooking on a high setting and reduce the setting when the food has heated through.

Simmering, cooking rice

- Simmering occurs below boiling point, at around 85°C, when bubbles are just rising occasionally to the surface of the cooking liquid. It is the key to delicious soups and tender stews because the flavours develop without overcooking the food. You should also cook egg-based and flourthickened sauces below boiling point.
- Some tasks, including cooking rice by the absorption method, may require a setting higher than the lowest setting to ensure the food is cooked properly in the time recommended.

Searing steak

To cook juicy flavoursome steaks:

1. Stand the meat at room temperature for about 20 minutes before cooking.

- 2.Heat up a heavy-based frying pan.
- 3.Brush both sides of the steak with oil. Drizzle a small amount of oil into the hot pan and then lower the meat onto the hot pan.
- 4.Turn the steak only once during cooking. The exact cooking time will depend on the thickness of the steak and how cooked you want it. Times may vary from about 2 – 8 minutes per side. Press the steak to gauge how cooked it is – the firmer it feels the more ‘well done’ it will be.
- 5.Leave the steak to rest on a warm plate for a few minutes to allow it to relax and become tender before serving.

For stir-frying

- 1.Choose a ceramic compatible flat-based wok or a large frying pan.
- 2.Have all the ingredients and equipment ready. Stir-frying should be quick. If cooking large quantities, cook the food in several smaller batches.
- 3.Preheat the pan briefly and add two tablespoons of oil.
- 4.Cook any meats first, put it inside and keep warm.
- 5.Stir-fry the vegetables. When they are hot but still crisp, turn the cooking zone to a lower setting, return the meat to the pan and add your sauce.
- 6.Stir the ingredients gently to make sure they are heated through.
- 7.Serve immediately.

Heat Settings

Heat setting	Suitability
1 - 2	<ul style="list-style-type: none"> • delicate warming for small amounts of food • melting chocolate, butter, and foods that burn quickly • gentle simmering • slow warming
3 - 4	<ul style="list-style-type: none"> • reheating • rapid simmering • cooking rice
5 - 6	<ul style="list-style-type: none"> • pancakes
7 - 8	<ul style="list-style-type: none"> • sauteing • cooking pasta
9	<ul style="list-style-type: none"> • stir-frying • searing • bringing soup to the boil • boiling water

Care and Cleaning

What?	How?	Important!
<p>Everyday soiling on glass (fingerprints, marks, stains left by food or non-sugary spillovers on the glass)</p>	<ol style="list-style-type: none"> 1. Switch the power to the cooktop off. 2. Apply a cooktop cleaner while the glass is still warm (but not hot!) 3. Rinse and wipe dry with a clean cloth or paper towel. 4. Switch the power to the cooktop back on. 	<ul style="list-style-type: none"> • When the power to the cooktop is switched off, there will be no 'hot surface' indication but the cooking zone may still be hot! Take extreme care. • Heavy-duty scourers, some nylon scourers and harsh/abrasive cleaning agents may scratch the glass. Always read the label to check if your cleaner or scourer is suitable. • Never leave cleaning residue on the cooktop: the glass may become stained.
<p>Boilovers, melts, and hot sugary spills on the glass</p>	<p>Remove these immediately with a fish slice, palette knife or razor blade scraper suitable for ceramic glass cooktops, but beware of hot cooking zone surfaces:</p> <ol style="list-style-type: none"> 1. Switch the power to the cooktop off at the wall. 2. Hold the blade or utensil at a 30° angle and scrape the soiling or spill to a cool area of the cooktop. 3. Clean the soiling or spill up with a dish cloth or paper towel. 4. Follow steps 2 to 4 for 'Everyday soiling on glass' above. 	<ul style="list-style-type: none"> • Remove stains left by melts and sugary food or spillovers as soon as possible. If left to cool on the glass, they may be difficult to remove or even permanently damage the glass surface. • Cut hazard: when the safety cover is retracted, the blade in a scraper is razor-sharp. Use with extreme care and always store safely and out of reach of children.
<p>Spillovers on the touch controls</p>	<ol style="list-style-type: none"> 1. Switch the power to the cooktop off. 2. Soak up the spill 3. Wipe the touch control area with a clean damp sponge or cloth. 4. Wipe the area completely dry with a paper towel. 5. Switch the power to the cooktop back on. 	<ul style="list-style-type: none"> • The cooktop may beep and turn itself off, and the touch controls may not function while there is liquid on them. Make sure you wipe the touch control area dry before turning the cooktop back on.

Hints and Tips

Problem	Possible causes	What to do
The cooktop cannot be turned on.	No power.	Make sure the cooktop is connected to the power supply and that it is switched on. Check whether there is a power outage in your home or area. If you've checked everything and the problem persists, call a qualified technician.
The touch controls are unresponsive.	The controls are locked.	Unlock the controls. See section 'Using your ceramic cooktop' for instructions.
The touch controls are difficult to operate.	There may be a slight film of water over the controls or you may be using the tip of your finger when touching the controls.	Make sure the touch control area is dry and use the ball of your finger when touching the controls.
The glass is being scratched.	Rough-edged cookware. Unsuitable, abrasive scourer or cleaning products being used.	Use cookware with flat and smooth bases. See 'Choosing the right cookware'. See 'Care and cleaning'.
Some pans make crackling or clicking noises.	This may be caused by the construction of your cookware (layers of different metals vibrating differently).	This is normal for cookware and does not indicate a fault.
The induction cooktop makes a low humming noise when used on a high heat setting.	This is caused by the technology of induction cooking.	This is normal, but the noise should quieten down or disappear completely when you decrease the heat setting.
Fan noise coming from the induction cooktop.	A cooling fan built into your induction cooktop has come on to prevent the electronics from overheating. It may continue to run even after you've turned the induction cooktop off.	This is normal and needs no action. Do not switch the power to the induction cooktop off at the wall while the fan is running.
Pans do not become hot and appears in the display.	The induction cooktop cannot detect the pan because it is not suitable for induction cooking. The induction cooktop cannot detect the pan because it is too small for the cooking zone or not properly centered on it.	Use cookware suitable for induction cooking. See section 'Choosing the right cookware'. Centre the pan and make sure that its base matches the size of the cooking zone.

The induction cooktop or a cooking zone has turned itself off unexpectedly, a tone sounds and an error code is displayed (typically alternating with one or two digits in the cooking timer display).	Technical fault.	Please note down the error letters and numbers, switch the power to the induction cooktop off at the wall, and contact a qualified technician.
---	------------------	--

Failure Display and Inspection

If an abnormality comes up, the induction cooktop will enter the protective state automatically and display corresponding protective codes:

Problem	Possible causes	What to do
E4/E5	Temperature sensor failure	Please contact the supplier.
E7/E8	Temperature sensor of the IGBT failure.	Please contact the supplier.
E2/E3	Abnormal supply voltage	Please inspect whether power supply is normal. Power on after the power supply is normal.
E6/E9	Bad induction cooktop heat radiation	Please restart after the induction cooktop cools down.

The above are the judgment and inspection of common failures.

Please do not disassemble the unit by yourself to avoid any dangers and damages to the induction cooktop.

Technical Specification

Induction Cooktop	EMPV-36EC01
Cooking Zones	5 Zones
Supply Voltage	240V~ 60Hz
Installed Electric Power	9300W
Product Size D×W×H(in)	36 x 21 x 2-5/16
Building-in Dimensions A×B (in)	33-7/8 x 19-5/16

Induction Cooktop	EMPV-30EC02
Cooking Zones	4 Zones
Supply Voltage	240V~ 60Hz
Installed Electric Power	7200W
Product Size D×W×H(in)	30 x 21 x 2-5/16
Building-in Dimensions A×B (in)	28-3/4 x 19-5/16

Induction Cooktop	EMPV-24EC03
Cooking Zones	4 Zones
Supply Voltage	240V~ 60Hz
Installed Electric Power	7200W
Product Size D×W×H(in)	23-5/8 x 20-1/2 x 2-5/16
Building-in Dimensions A×B (in)	22-1/16 x 19-5/16

Weight and Dimensions are approximate. Because we continually strive to improve our products. We may change specifications and designs without prior notice.

Installation

Warning: To eliminate the risk of burns or fire by reaching over heated surface units, cabinet storage space located above the surface units should be avoided. If cabinet storage is to be provided, the risk can be reduced by installing a range hood that projects horizontally a minimum of 5 inches beyond the bottom of the cabinets.

Minimum spacings drawings (Generally requirement):

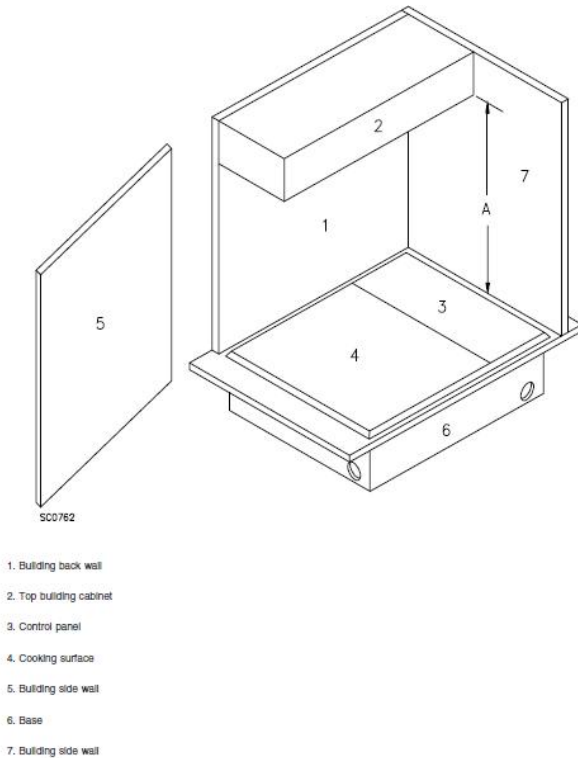

A = 30 inches minimum clearance between the top of the cooking surface and the bottom of an unprotected wood or metal cabinet; or A = 24 inches minimum when bottom of wood or metal cabinet is protected by not less than 1/4-inch-thick flame-retardant millboard covered with not less than No. 28 MSG sheet steel, 1/64-inch-thick stainless steel, 1/32-inch-thick aluminum, or 1/32-inch-thick copper.

Selection of installation equipment

- Cut out the work surface according to the sizes shown in the drawing.
- For the purpose of installation and use, a minimum of 1-31/32 in space shall be preserved around the hole.
- Be sure the thickness of the work surface is at least 1-3/16 in. Please select heat-resistant work surface material to avoid larger deformation caused by the heat radiation from the hotplate. As shown below: The work surface material must use the impregnated wood or other insulation material.
- **Ensure the table supporting the surface unit on the metal frame edge, see below right drawing.**

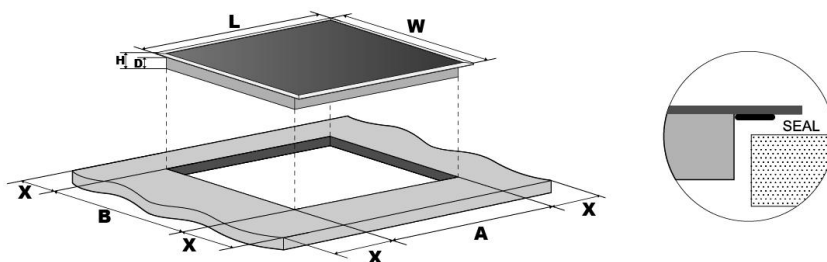

	L(in)	W(in)	H(in)	D(in)	A(in)	B(in)	X(in) min
EMPV-36EC01	36	21	2 5/16	2 1/8	33 7/8	19 5/16	1 31/32
EMPV-30EC02	30	21	2 5/16	2 1/8	28 3/4	19 5/16	1 31/32
EMPV-24EC03	23 5/8	20 1/2	2 5/16	2 1/8	22 1/16	19 5/16	1 31/32

Under any circumstances, make sure the cooktop is well ventilated and the air inlet and outlet are not blocked. Ensure the cooktop is in good work state. As shown below.

Note: The safety distance between the hotplate and the cupboard above the hotplate should be at least 30 inches (760mm).

A(in)	B(in)	C(in)	D	E
30	1-31/32 mini	13/16 mini	Air intake	Air exit 1/4 in

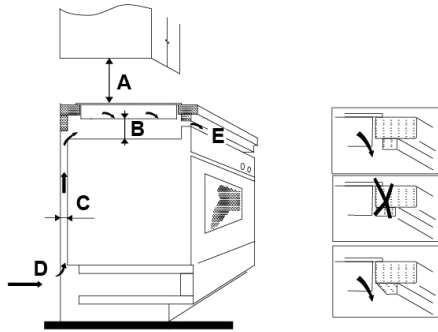

Before you install the cooktop, make sure that

- The work surface is square and level, and no structural members interfere with space requirements.
- The work surface is made of a heat-resistant material.
- If the cooktop is installed above an oven, the oven has a built-in cooling fan.
- The installation will comply with all clearance requirements and applicable standards and regulations.
- A suitable isolating switch providing full disconnection from the mains power supply is incorporated in the permanent wiring, mounted and positioned to comply with the local wiring rules and regulations.
- The isolating switch must be of an approved type and provide a 0.12in air gap contact separation in all poles (or in all active [phase] conductors if the local wiring rules allow for this variation of the requirements).
- The isolating switch will be easily accessible to the customer with the cooktop installed.
- You consult local building authorities and by-laws if in doubt regarding installation.
- You use heat-resistant and easy-to-clean finishes (such as ceramic tiles) for the wall surfaces surrounding the cooktop.

When you have installed the cooktop, make sure that

- The power supply cable is not accessible through cupboard doors or drawers.
- There is adequate flow of air from outside the cabinetry to the base of the cooktop.
- If the cooktop is installed above a drawer or cupboard space, a thermal protection barrier is installed below the base of the cooktop.
- The isolating switch is easily accessible by the customer.

Before locating the fixing brackets

The unit should be placed on a stable, smooth surface (use the packaging). Do not apply force onto the controls protruding from the cooktop.

Locating the fixing brackets

- The unit should be placed on a stable, smooth surface (use the packaging). Do not apply force onto the controls protruding from the cooktop.
- Fix the cooktop on the work surface by screw four brackets on the bottom of cooktop (see picture) after installation.
- Adjust the bracket position to suit for different work surface's thickness.

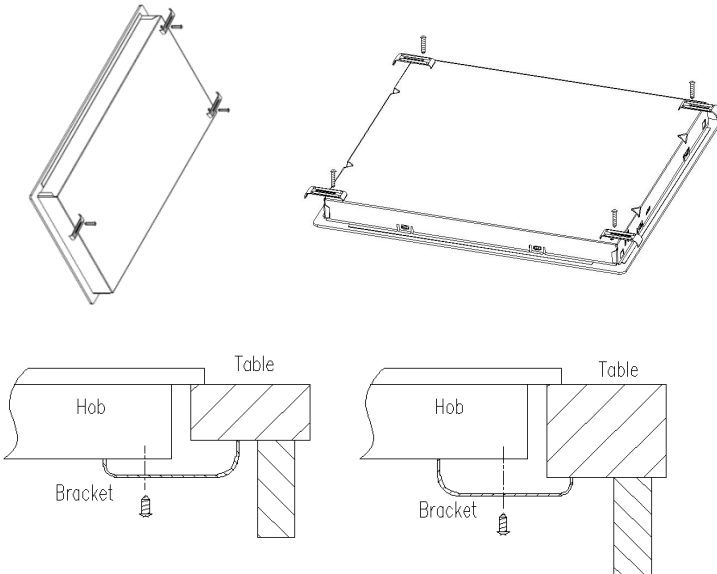

Cautions

- The cooktop must be installed by qualified personnel or technicians. We have professionals at your service. Please never conduct the operation by yourself.
- The cooktop shall not be mounted to cooling equipment, dishwashers and rotary dryers.
- The cooktop shall be installed such that better heat radiation can be ensured to enhance its reliability.
- The wall and induced heating zone above the work surface shall withstand heat.
- To avoid any damage, the sandwich layer and adhesive must be resistant to heat.

- A steam cleaner is not to be used.
- This ceramic can be connected only to a supply with system impedance no more than 0.427 ohm. In case necessary, please consult your supply authority for system impedance information.



DISPOSAL: Do not dispose this product as unsorted municipal waste. Collection of such waste separately for special treatment is necessary.

This appliance is labeled in compliance with European directive 2012/19/EU for Waste Electrical and Electronic Equipment (WEEE). By ensuring that this appliance is disposed of correctly, you will help prevent any possible damage to the environment and to human health, which might otherwise be caused if it were disposed of in the wrong way.

The symbol on the product indicates that it may not be treated as normal household waste. It should be taken to a collection point for the recycling of electrical and electronic goods.

This appliance requires specialist waste disposal. For further information regarding the treatment, recover and recycling of this product please contact your local council, your household waste disposal service, or the shop where you purchased it.

For more detailed information about treatment, recovery and recycling of this product, please contact your local city office, your household waste disposal service or the shop where you purchased the product.

Distributed by Empava Appliances Inc.

Add: 15253 Don Julian Road,

City of Industry, CA, 91745

Tel: (888)682-8882

WWW.EMPAVA.COM