

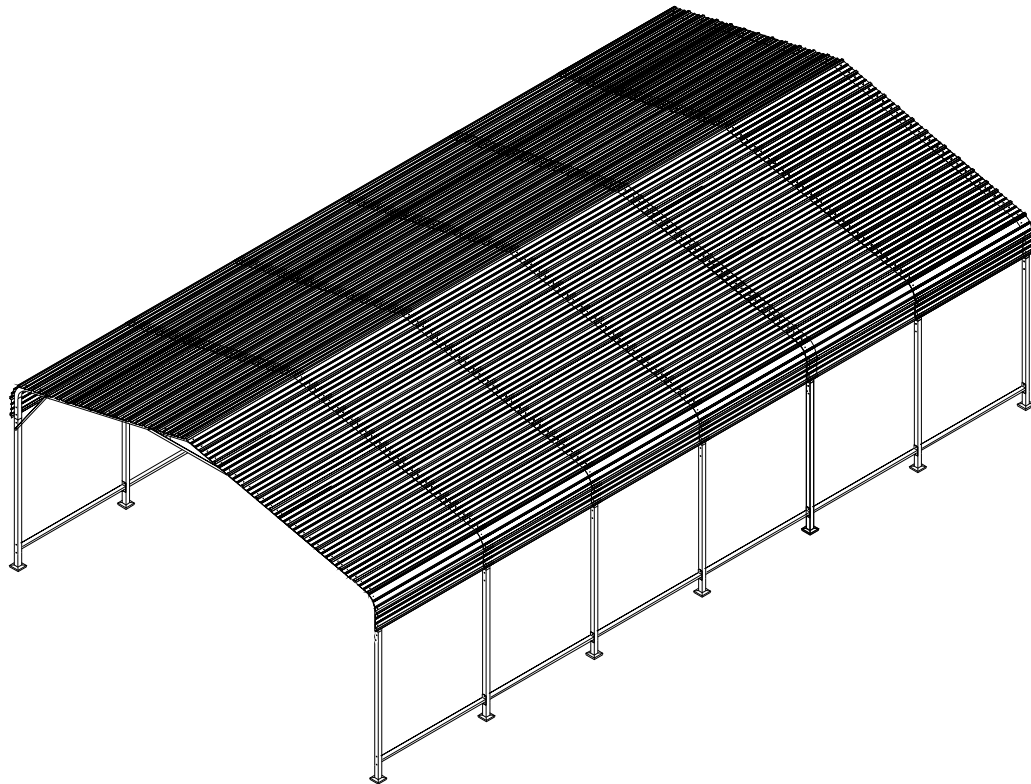

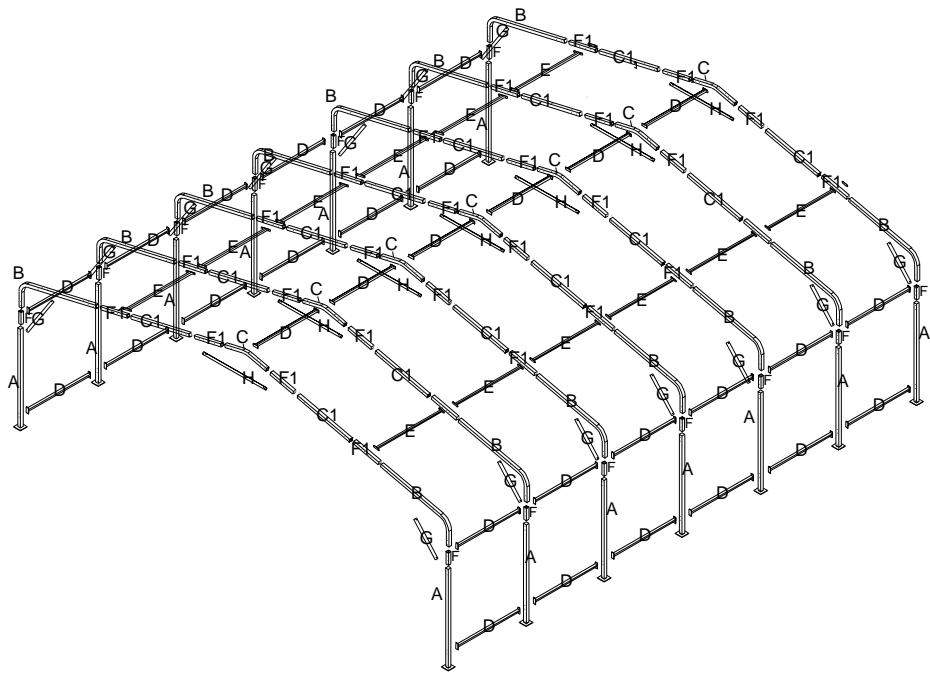

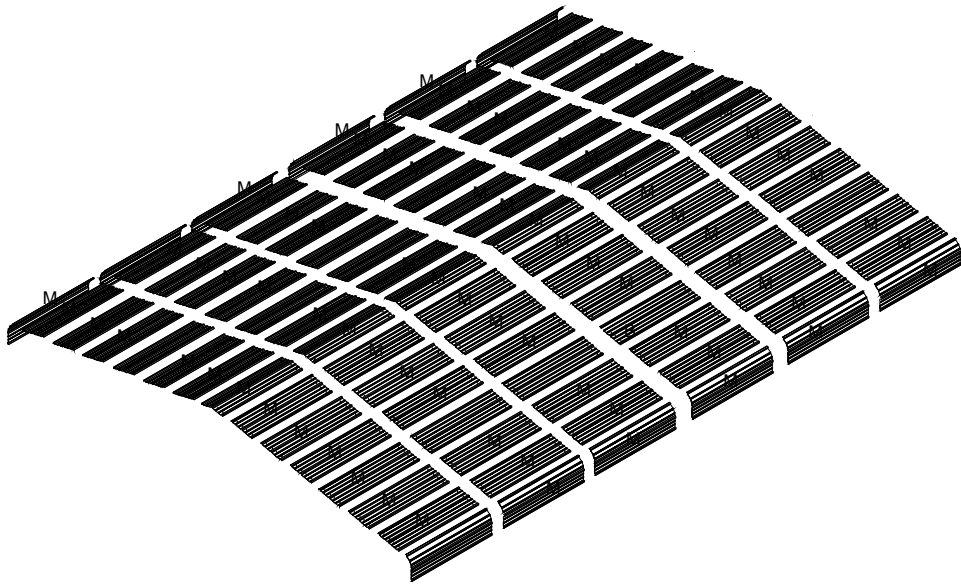

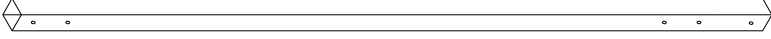

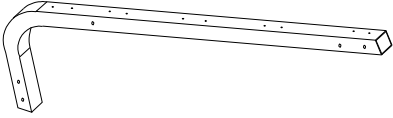

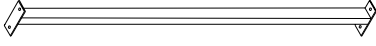

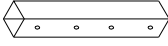
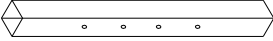



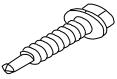

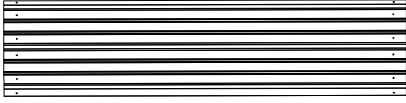

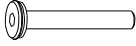
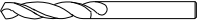

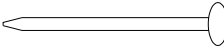
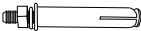
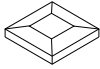
20X30Carport

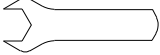

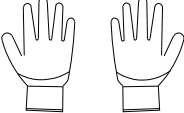

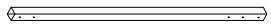



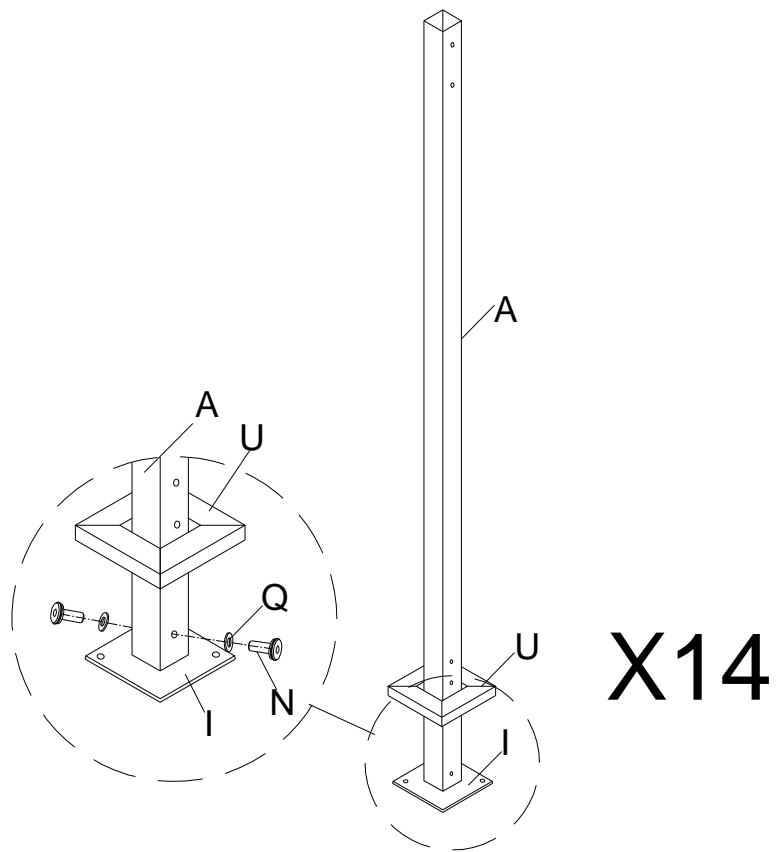

		A (X14)
	B (X14)	
	C1 (X14)	
	E (X12)	
	F1 (X28)	
	H (X7)	
	J (X422)+10	
	L (X1)	
	M6*15 N (X28)	
	Ø3.5 P (X1)	
	M6 R (X220)+10	
	M6x62 T (X28)	
	V (X1)	
	X (X2)	
		Y (X4)

Step1

PART	Qty	NO
	A	14
	I	14
	U	14
 M6*15	N	28
	Q	28



Step2

PART	Qty	NO
	C	7
	F1	14
	O	28
	Q	28
	R	28

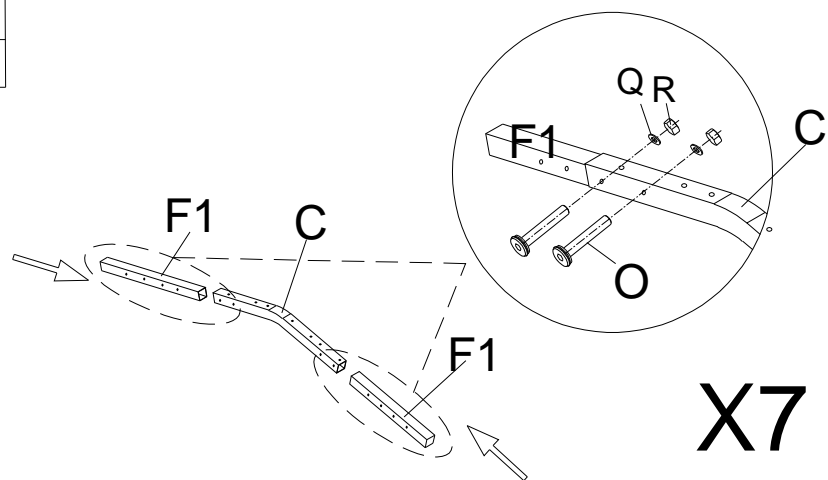

Step3

PART	Qty	NO
	B	14
	C1	14
	F1	14
	O	28
	Q	28
	R	28

Before assembly, measure the hole position of c1 and install it in the correct direction

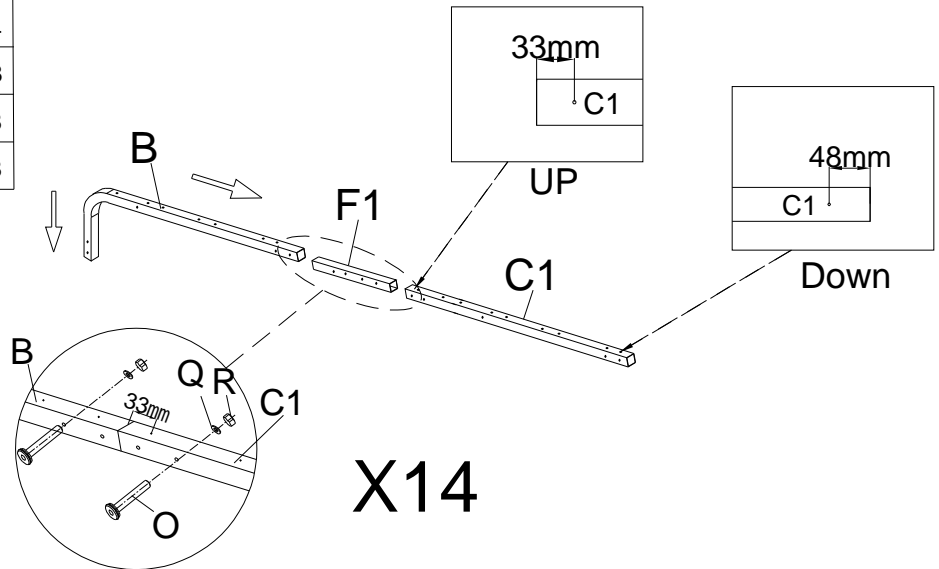



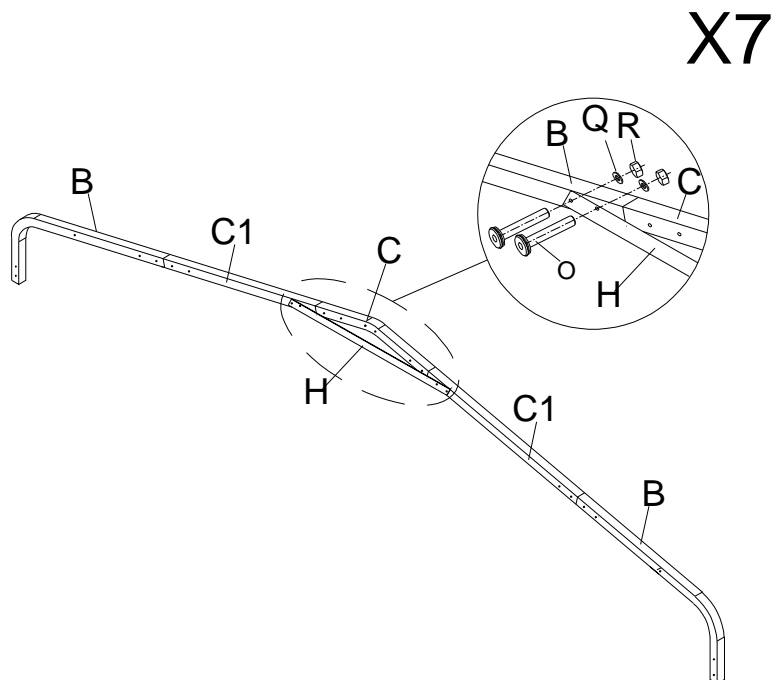

Step4

PART	Qty	NO
	H	7
	O	28
	Q	28
	R	28

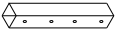



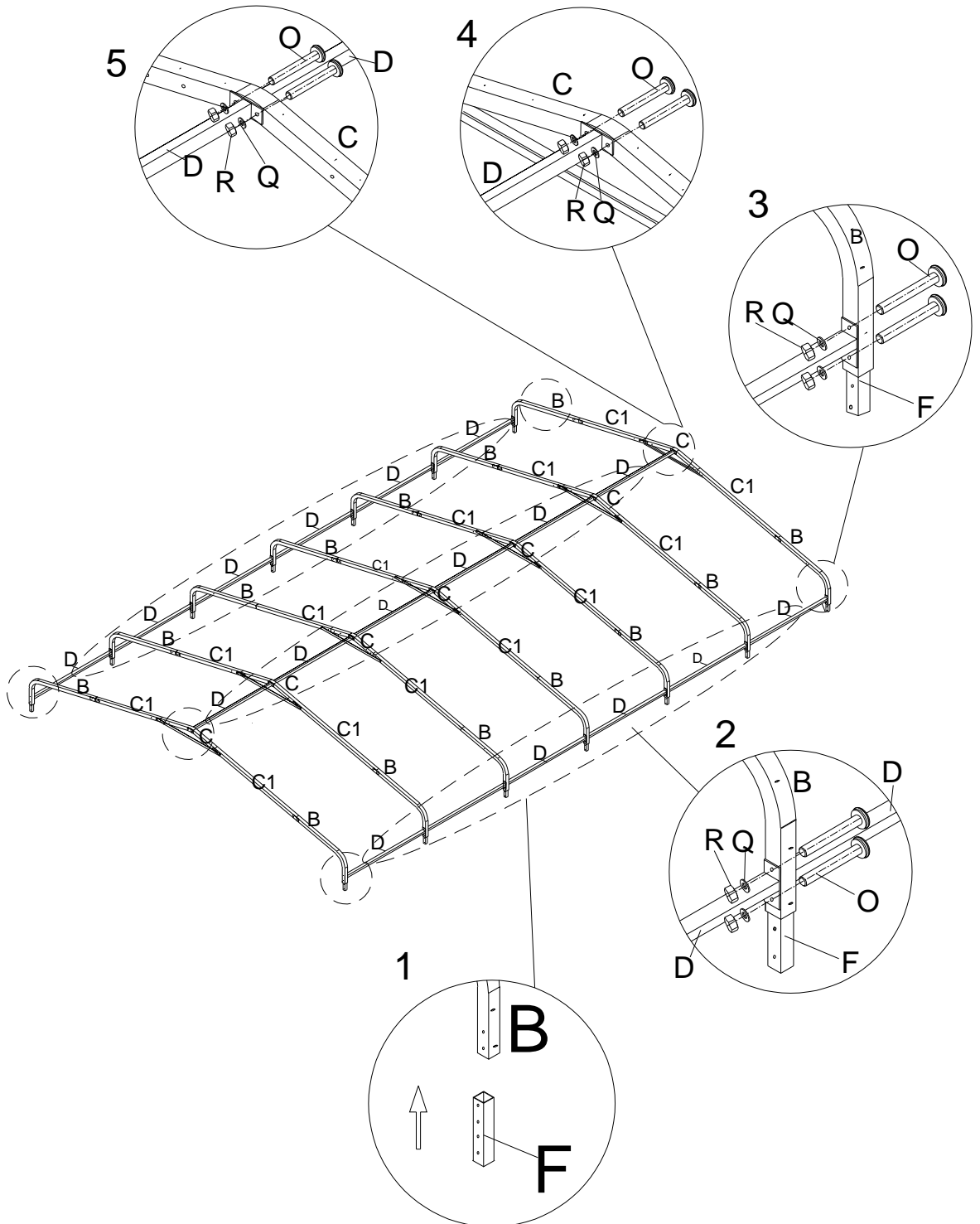

Step5

PART	Qty	NO
	F	14
	D	18
	O	42
	Q	42
	R	42



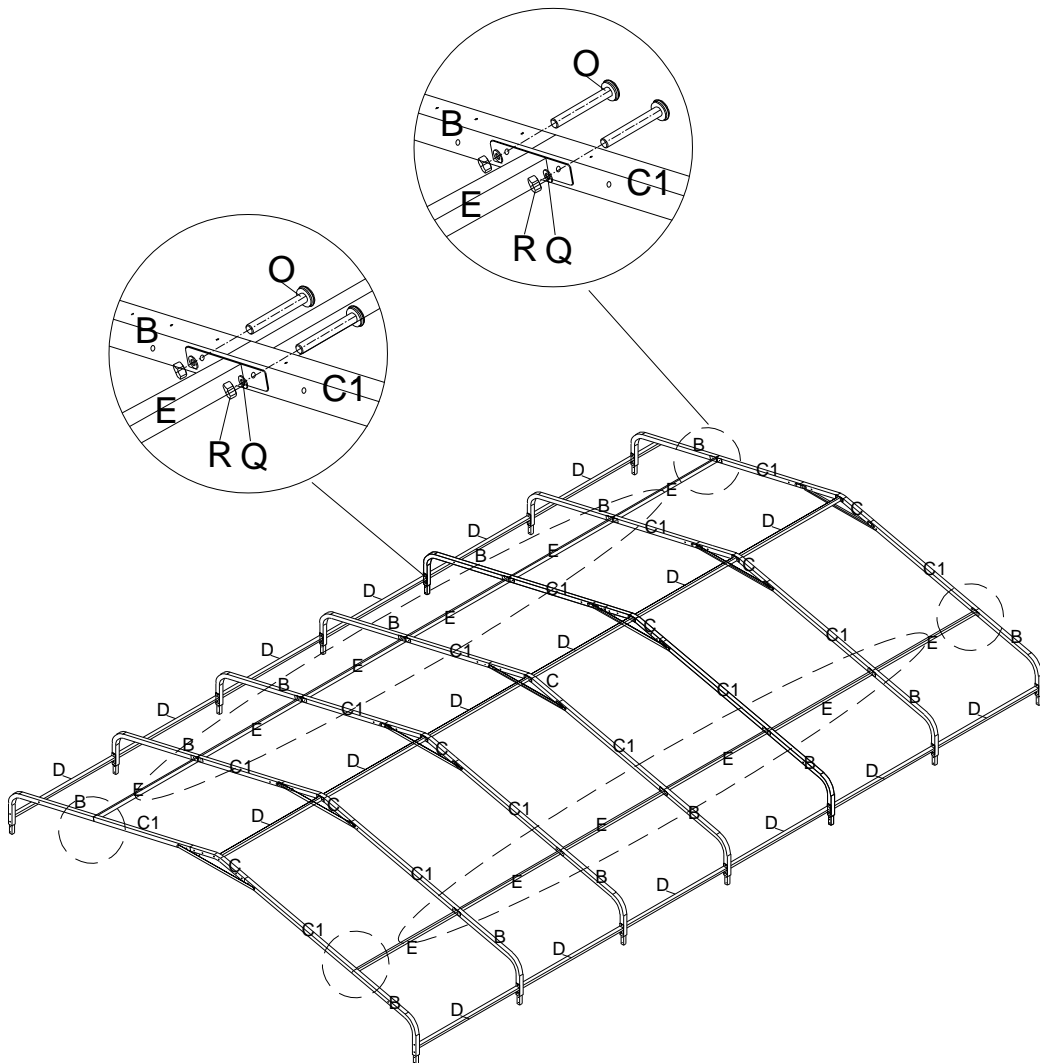

Step6

PART	Qty	NO
	E	12
	O	28
	Q	28
	R	28



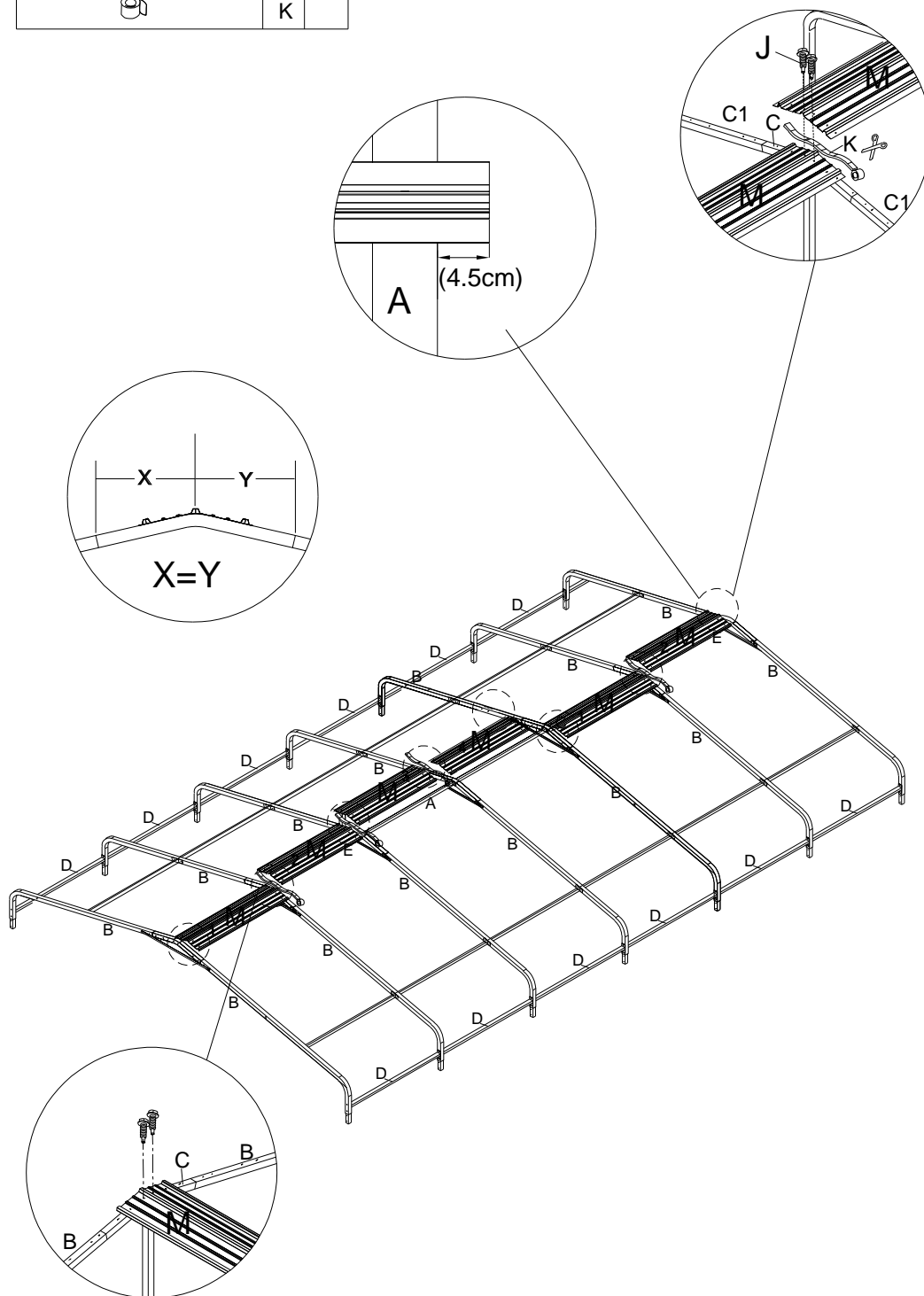

Step 7

PART	Qty	NO
	M	6
	J	14
	K	



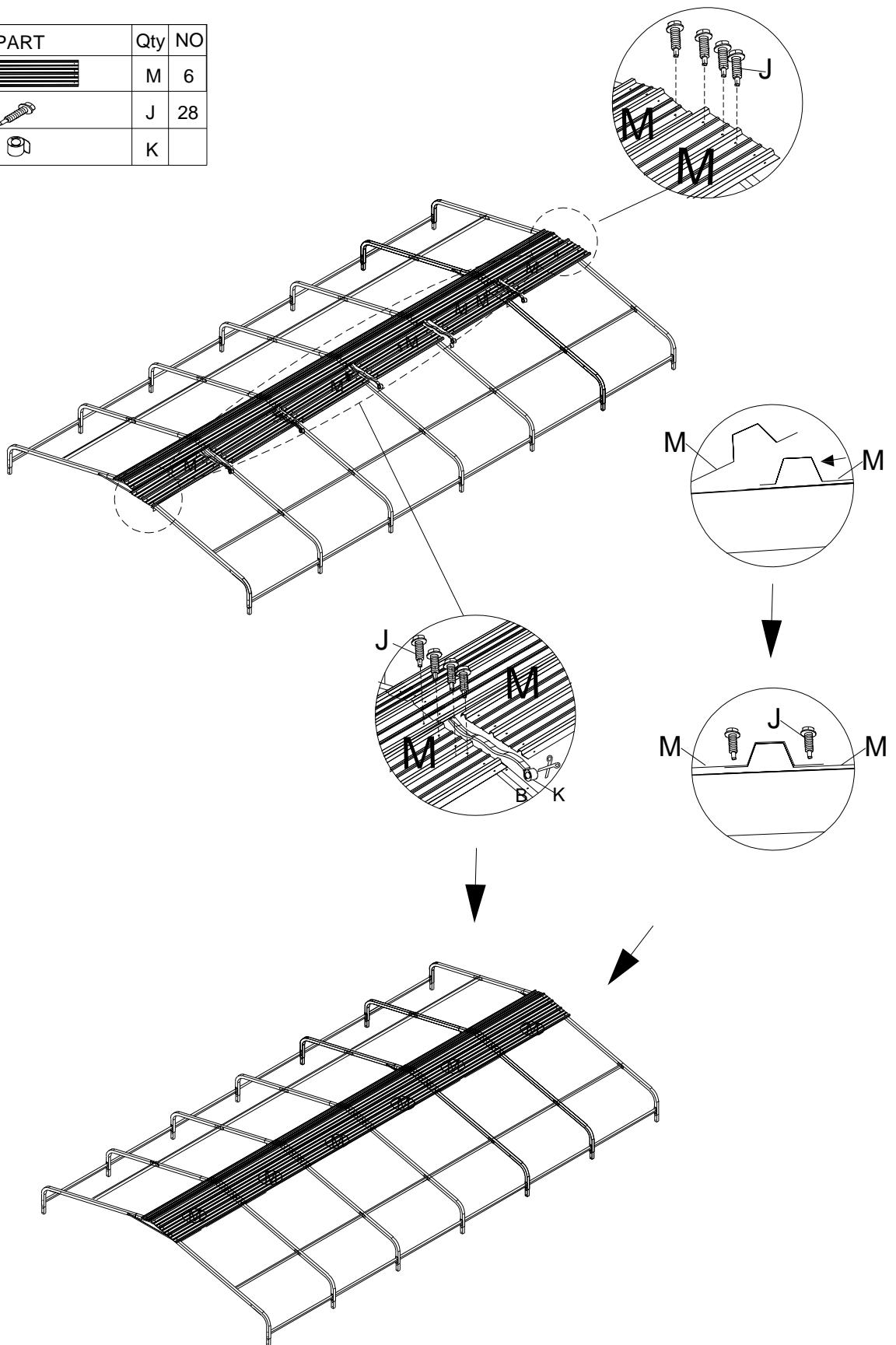

Step 8

PART	Qty	NO
	M	6
	J	28
	K	



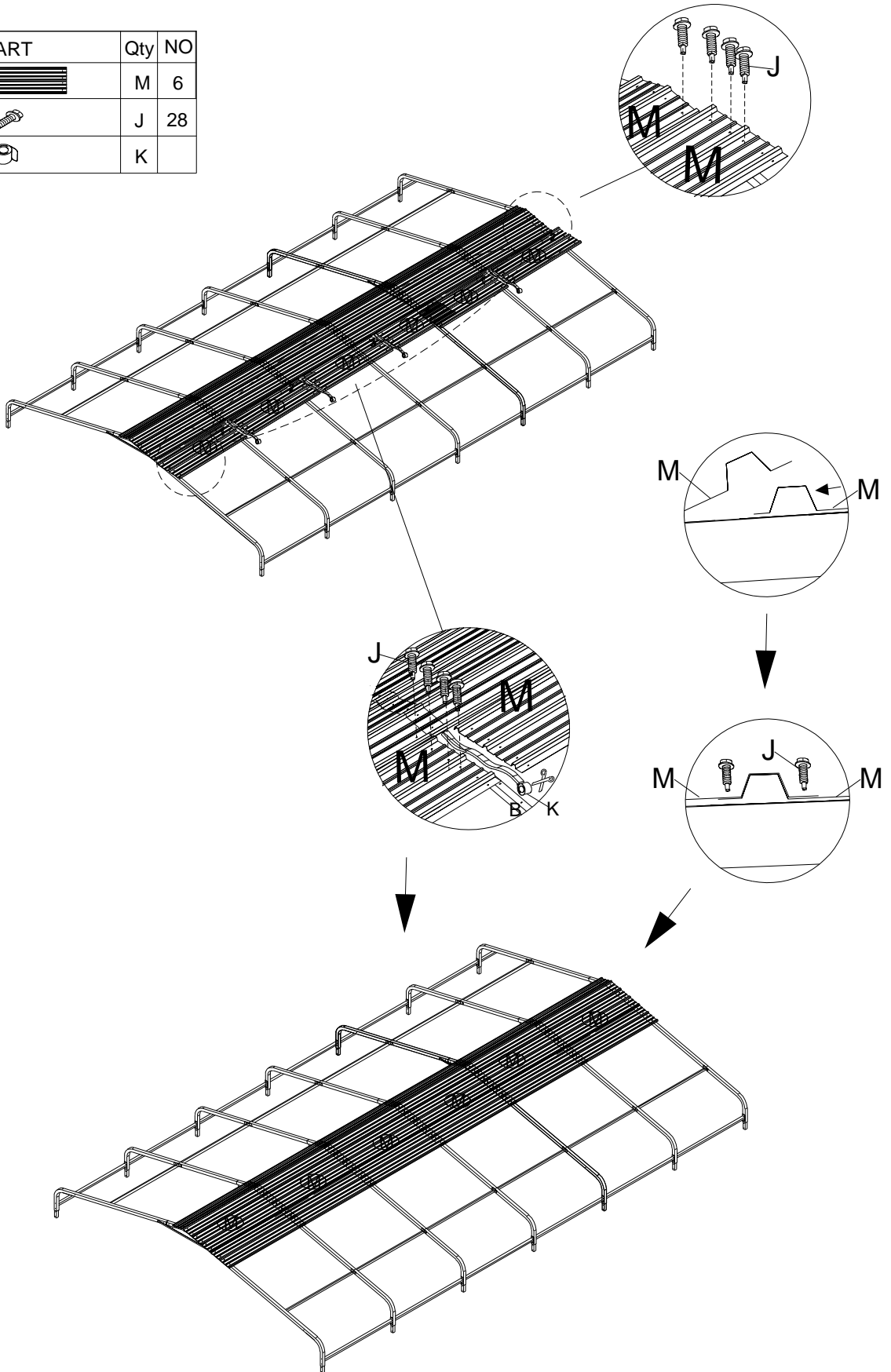

Step9

PART	Qty	NO
	M	6
	J	28
	K	



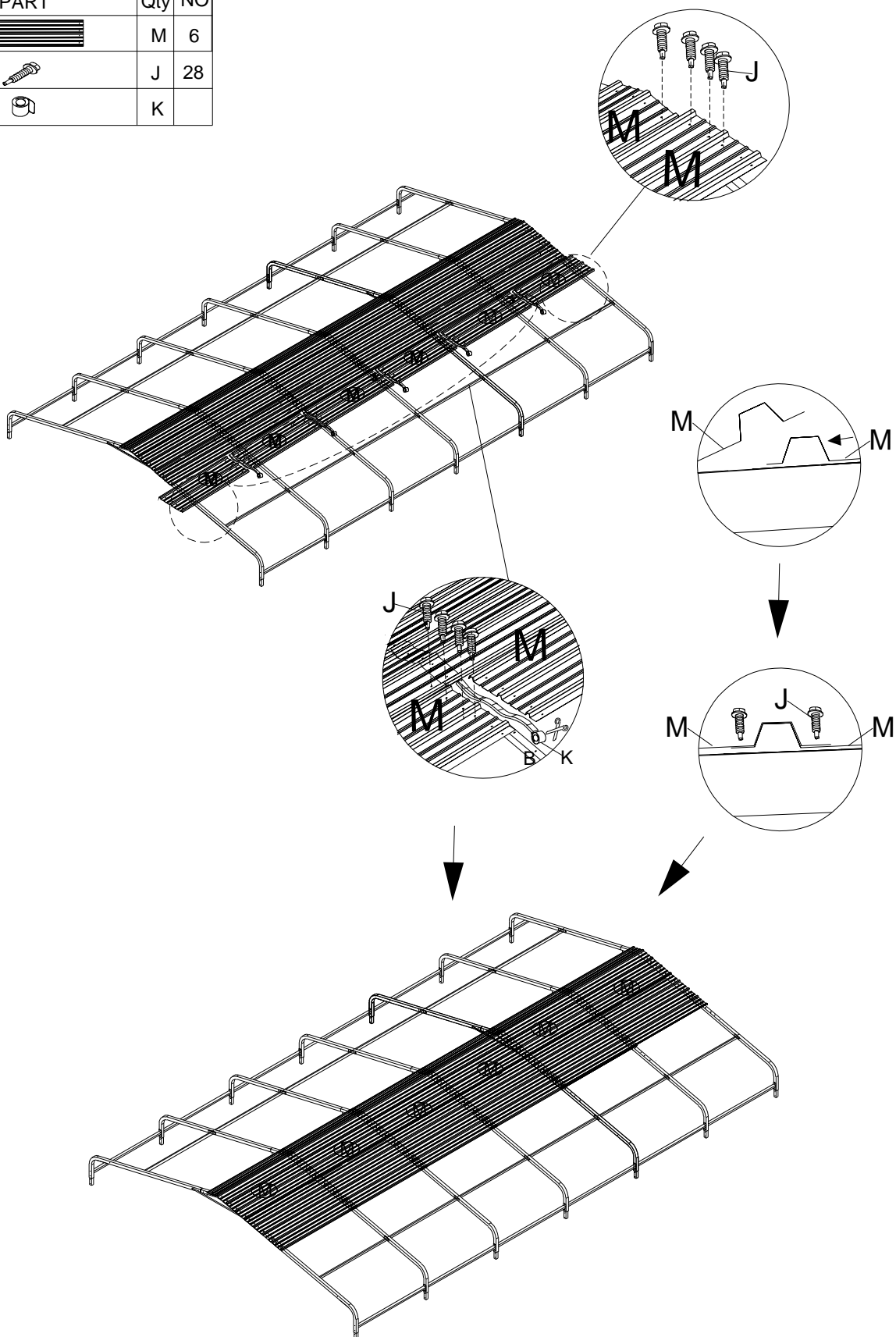

Step 10

PART	Qty	NO
	M	6
	J	28
	K	



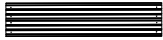

Step 11

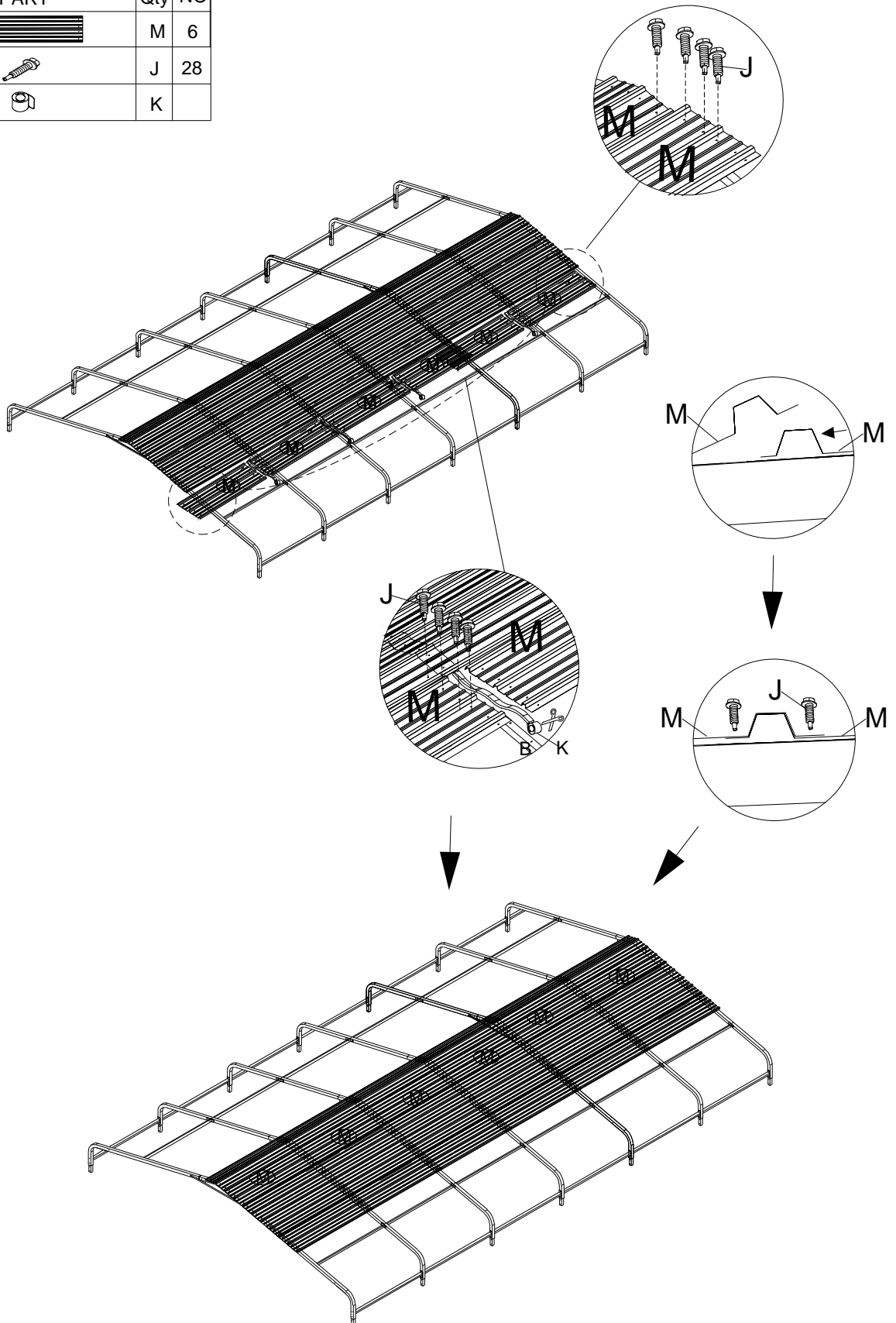
PART	Qty	NO
	M	6
	J	28
	K	



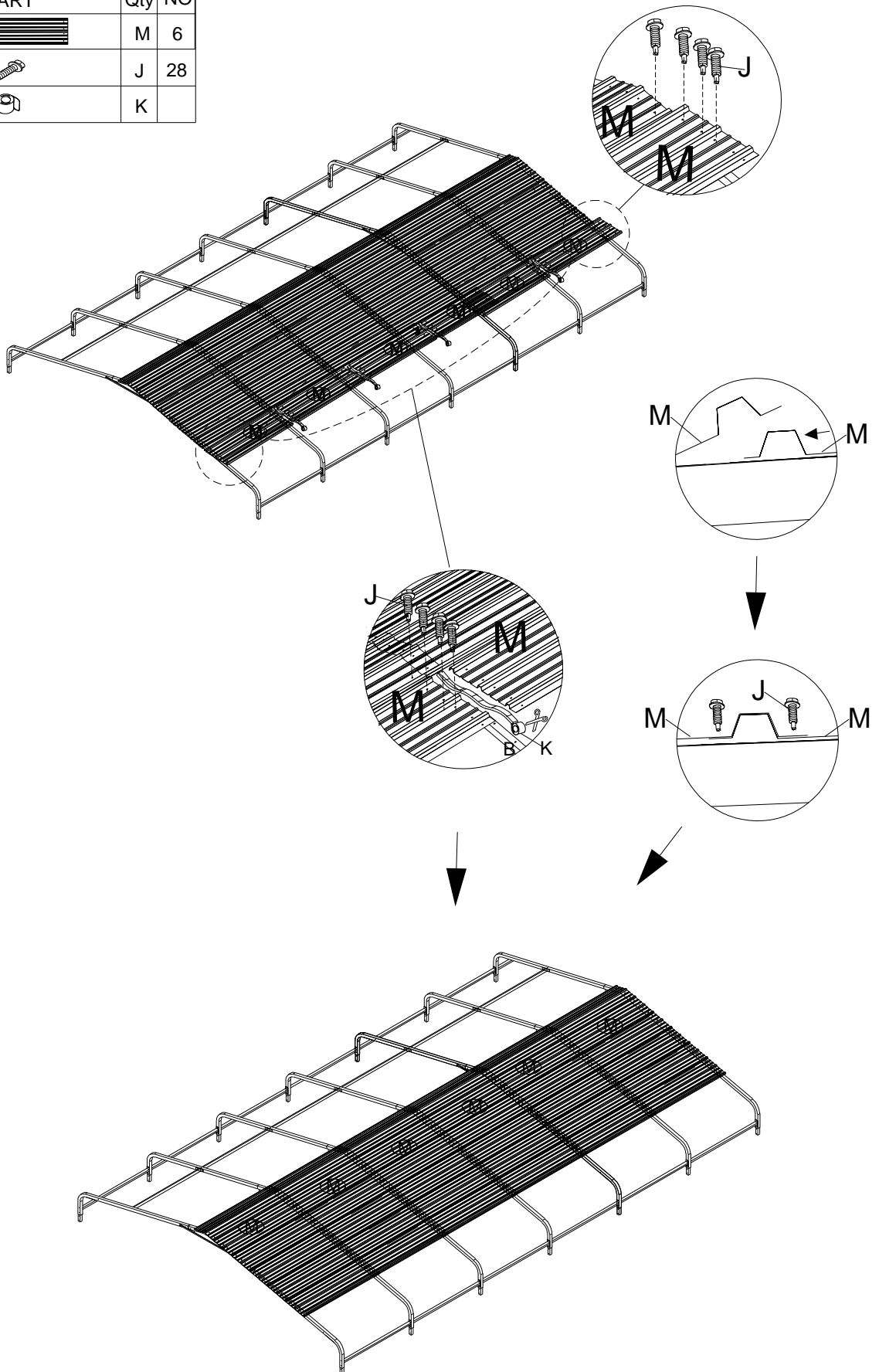

Step12

PART	Qty	NO
	M	6
	J	28
	K	



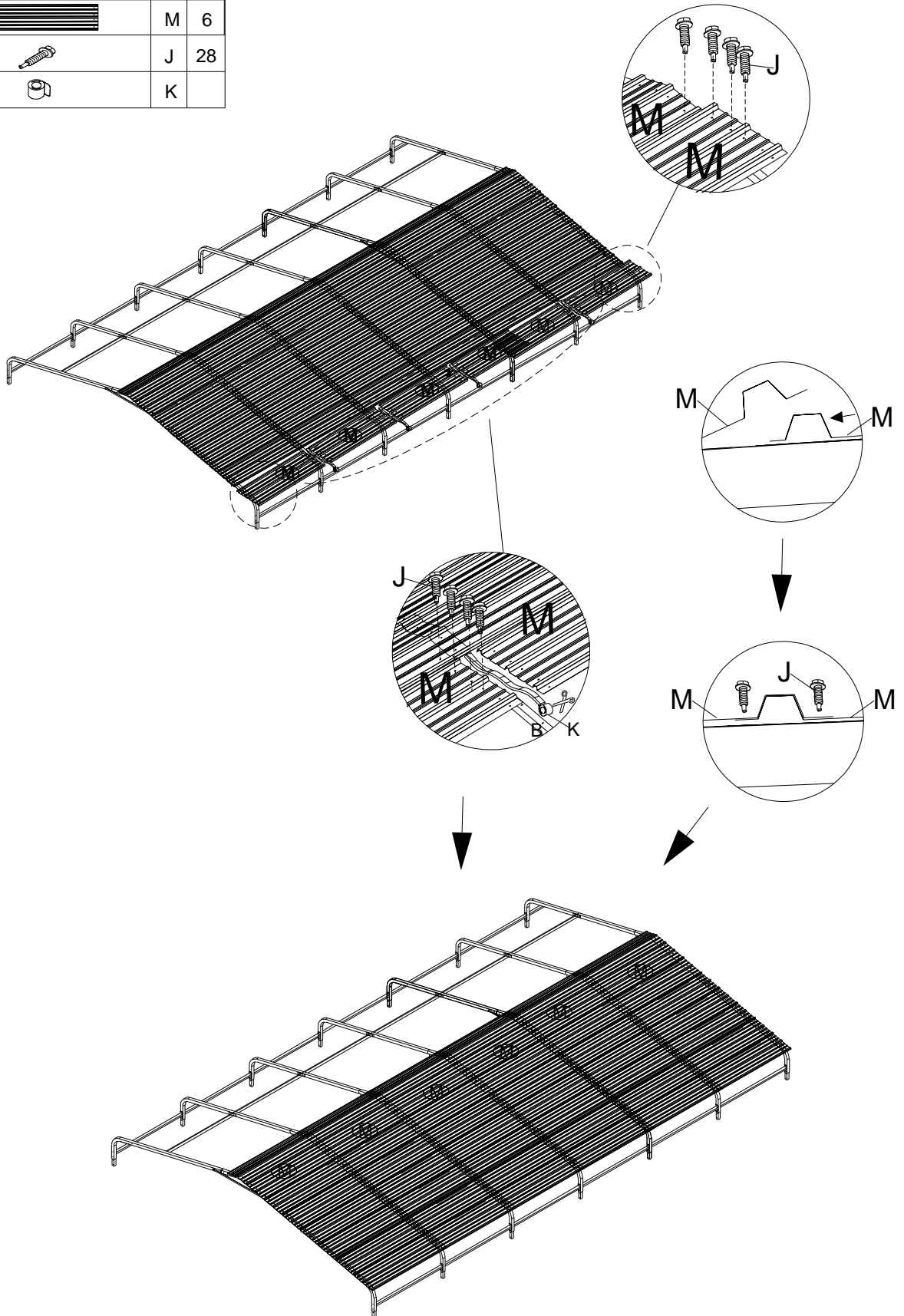

Step13

PART	Qty	NO
	M	6
	J	28
	K	



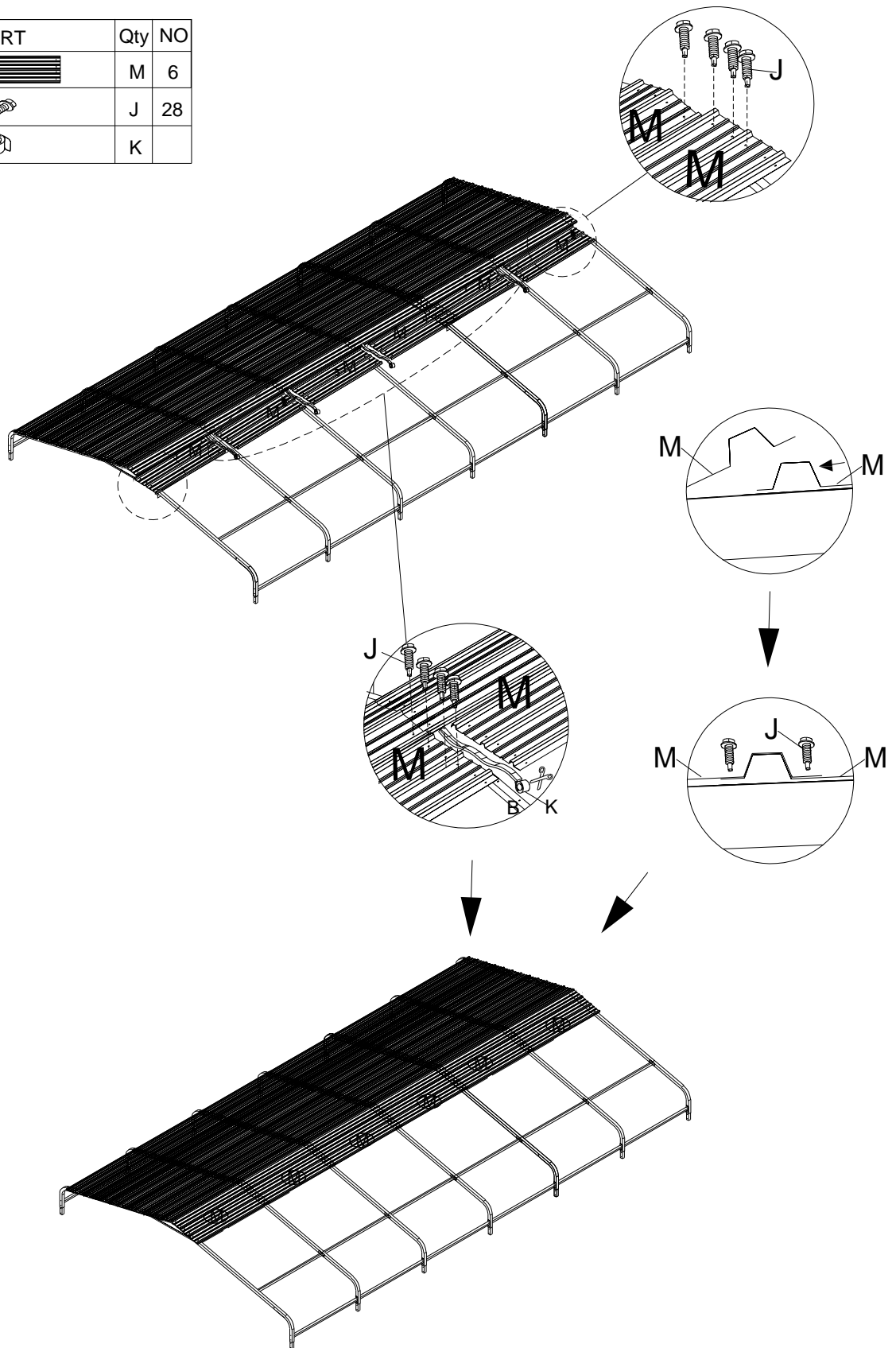

Step 14

PART	Qty	NO
	M	6
	J	28
	K	



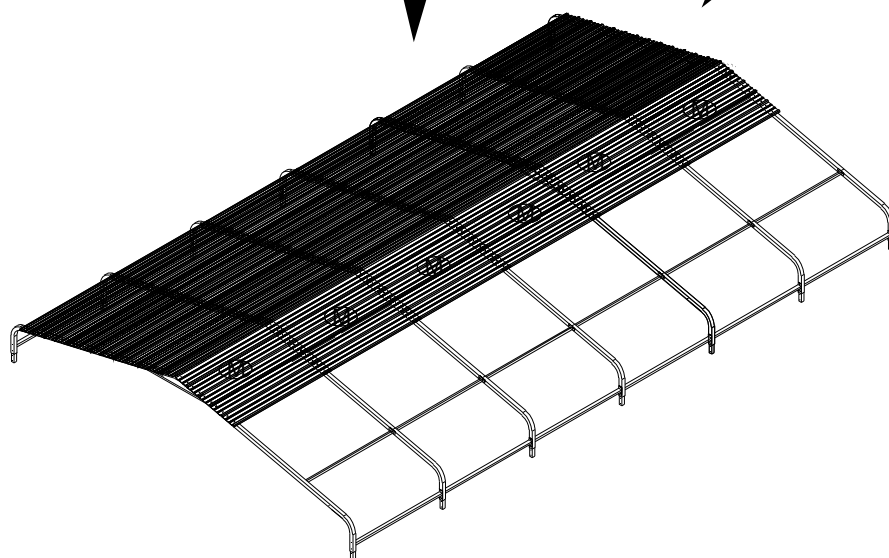
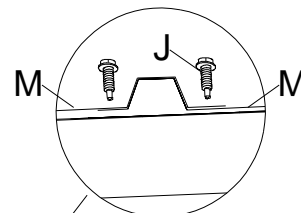
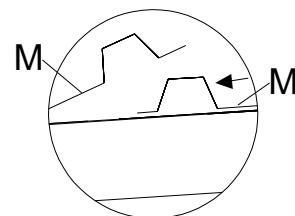
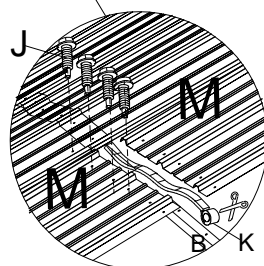
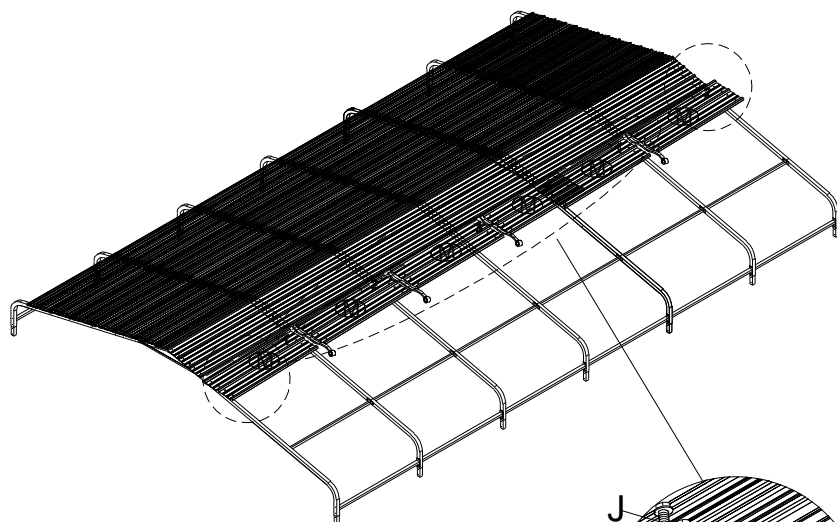
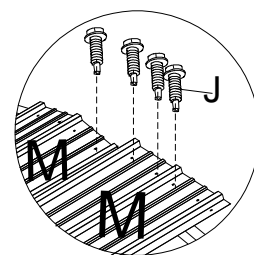

Step15

PART	Qty	NO
	M	6
	J	28
	K	



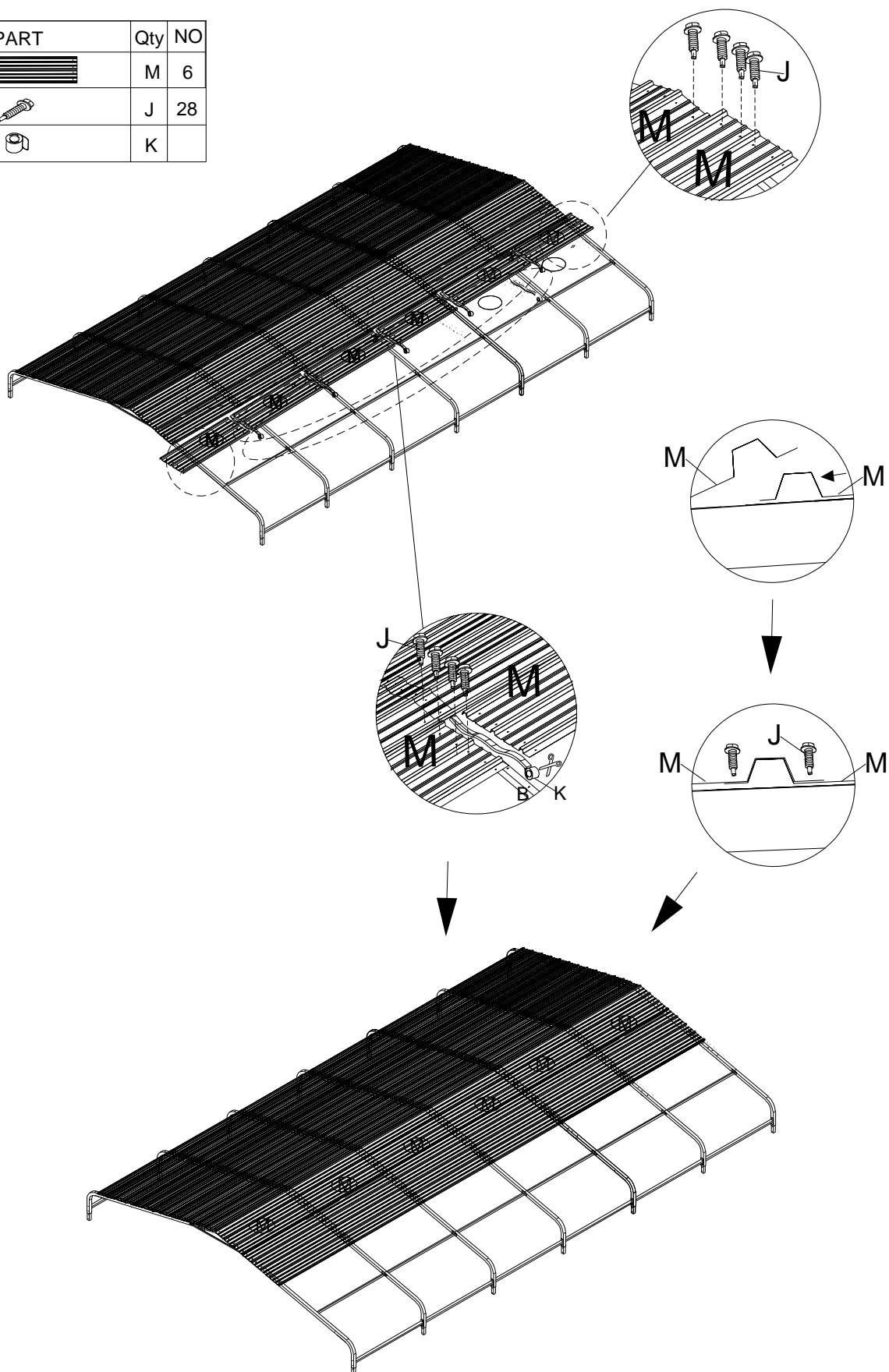

Step 16

PART	Qty	NO
	M	6
	J	28
	K	



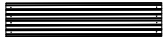

Step 17

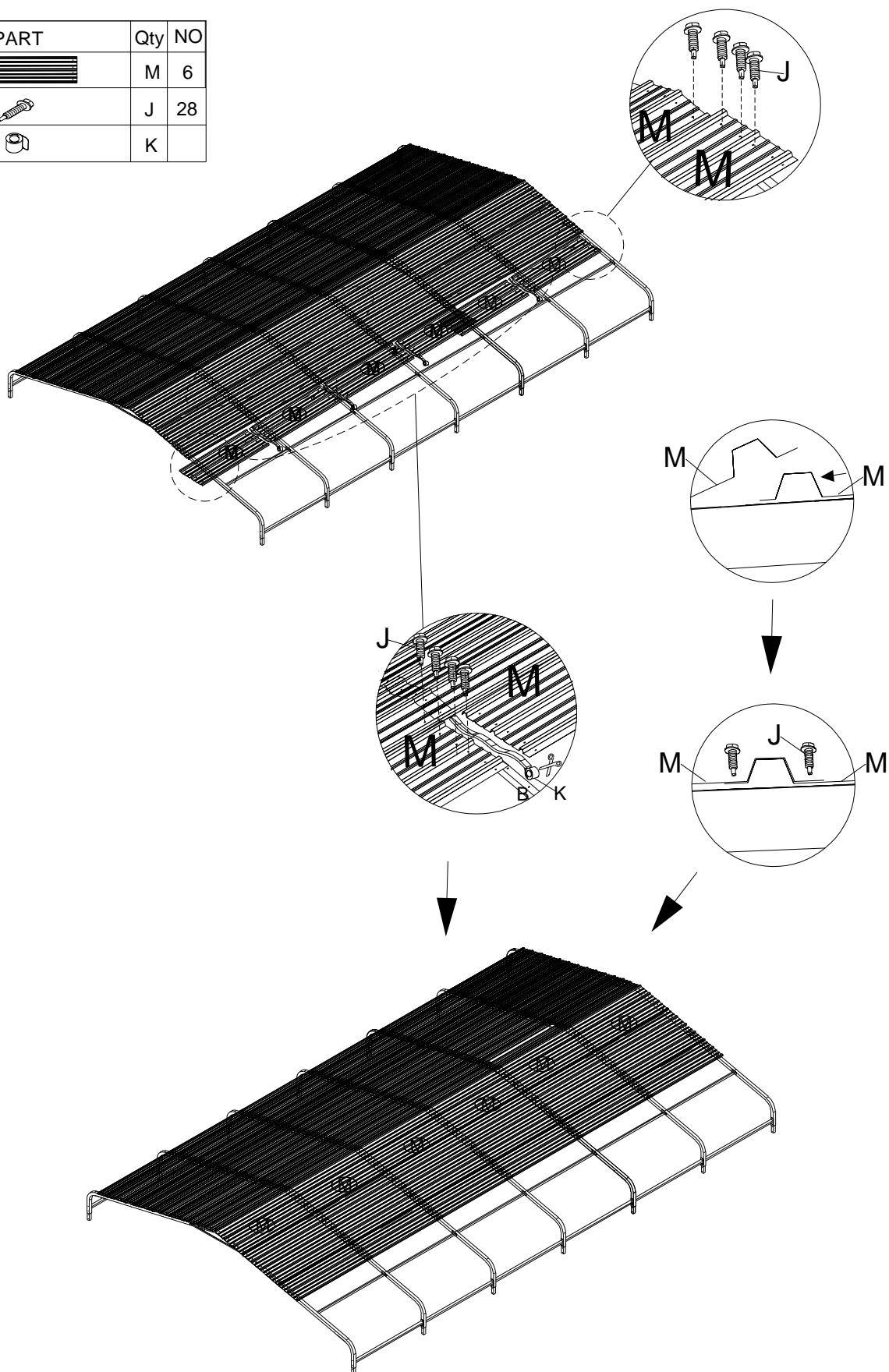
PART	Qty	NO
	M	6
	J	28
	K	



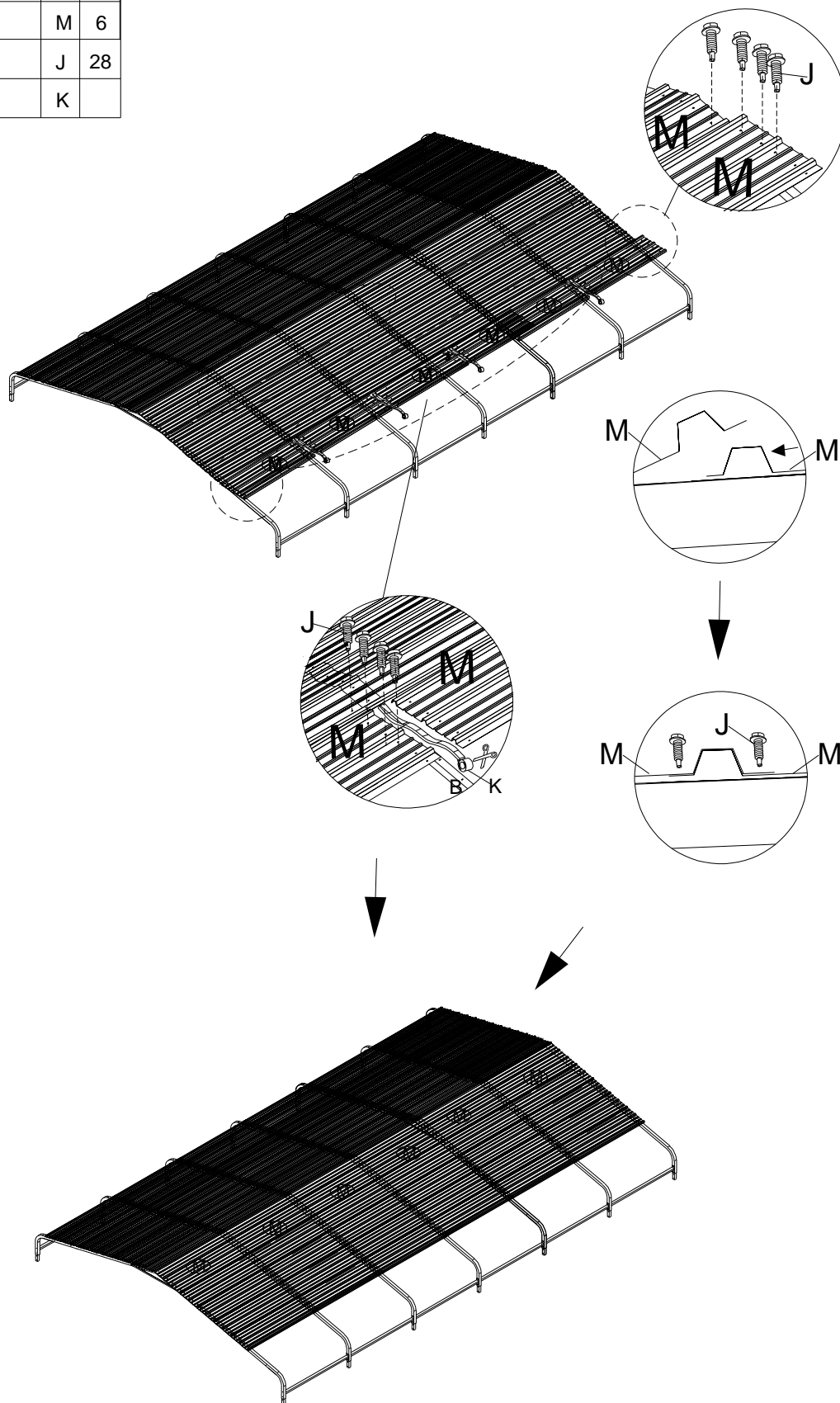

Step 18

PART	Qty	NO
	M	6
	J	28
	K	



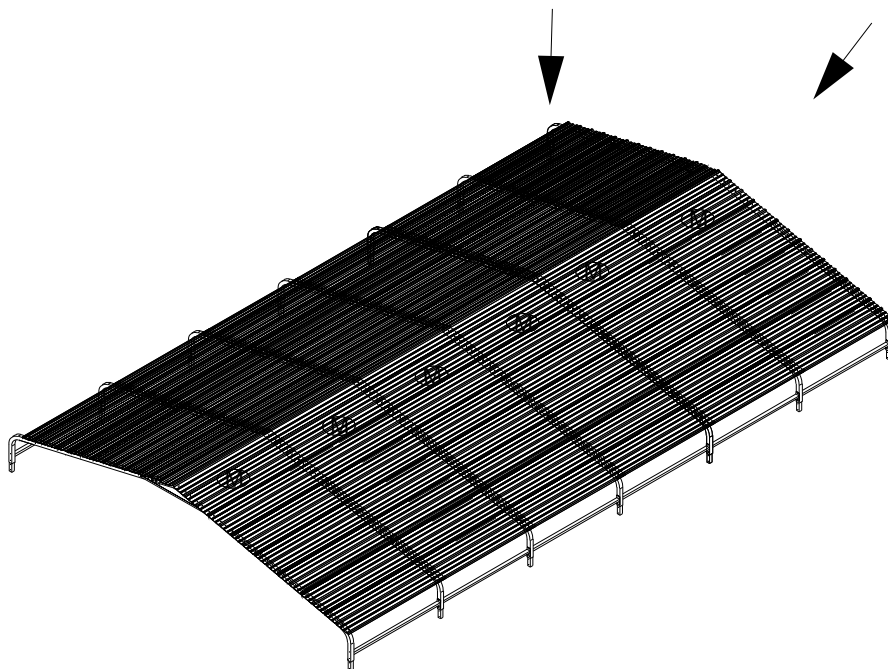
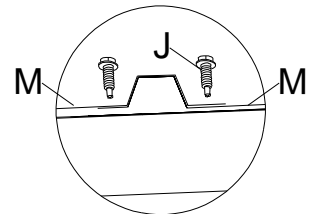
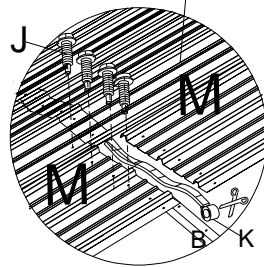
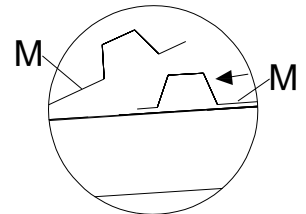
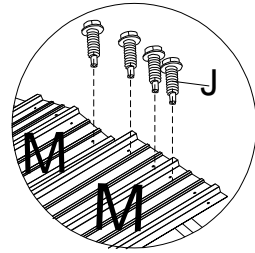
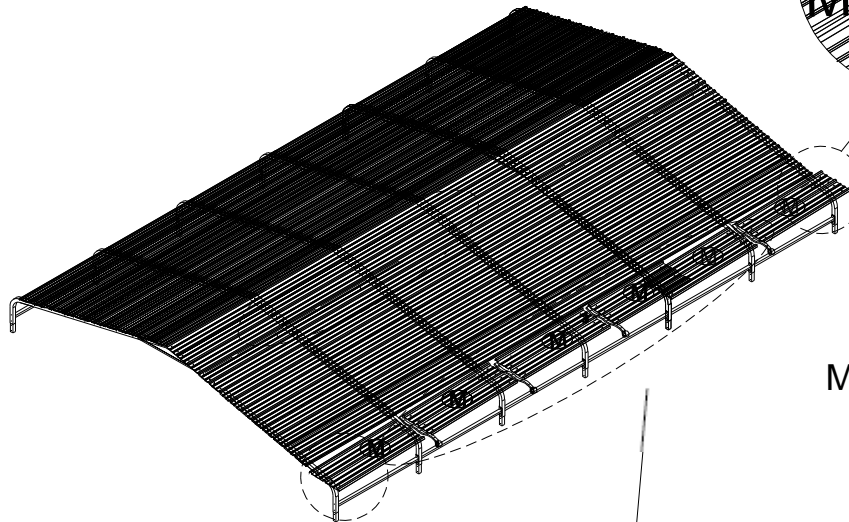

Step 19

PART	Qty	NO
	M	6
	J	28
	K	



Step20

PART	Qty	NO
	O	14
	Q	14
	R	14

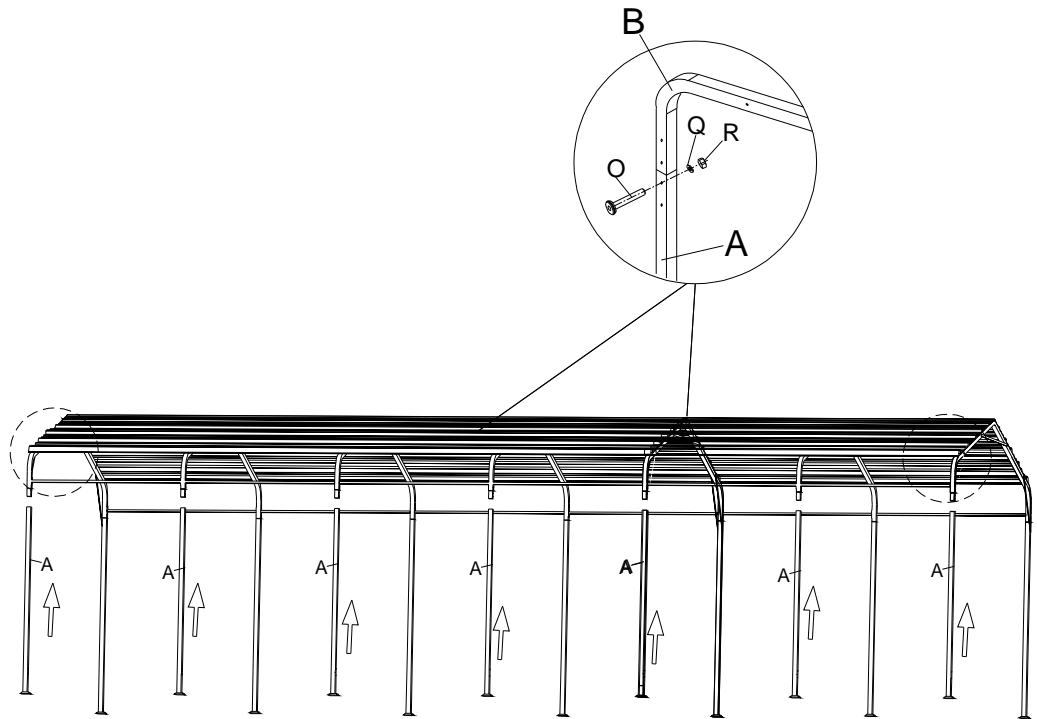
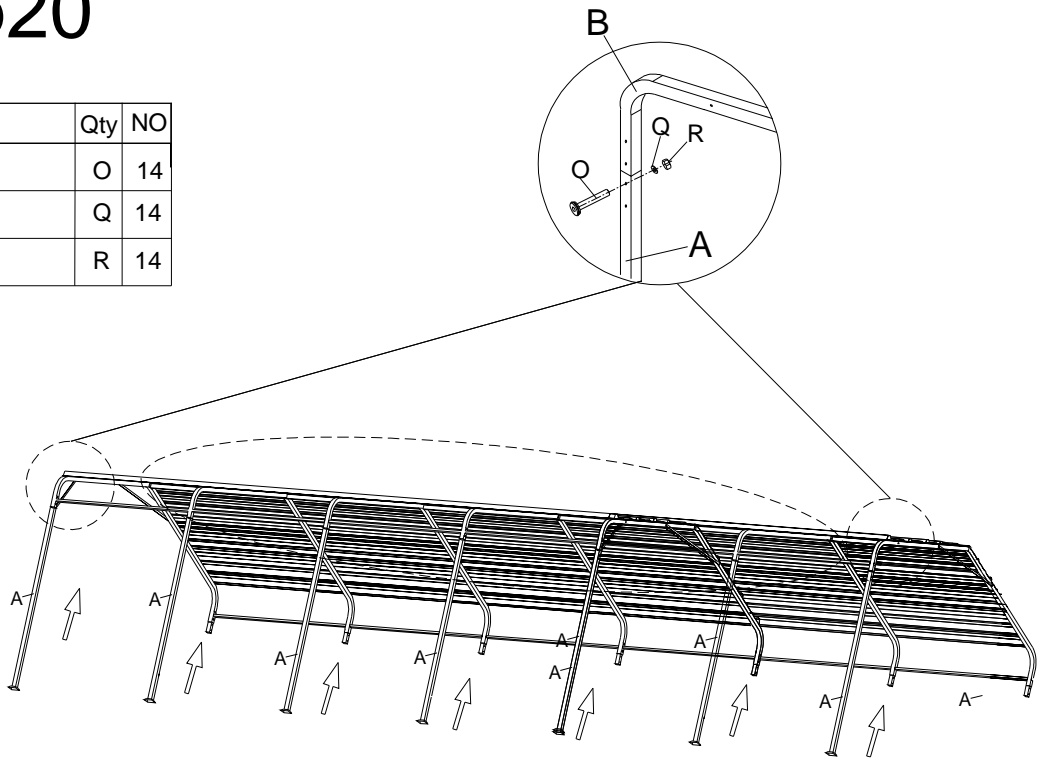

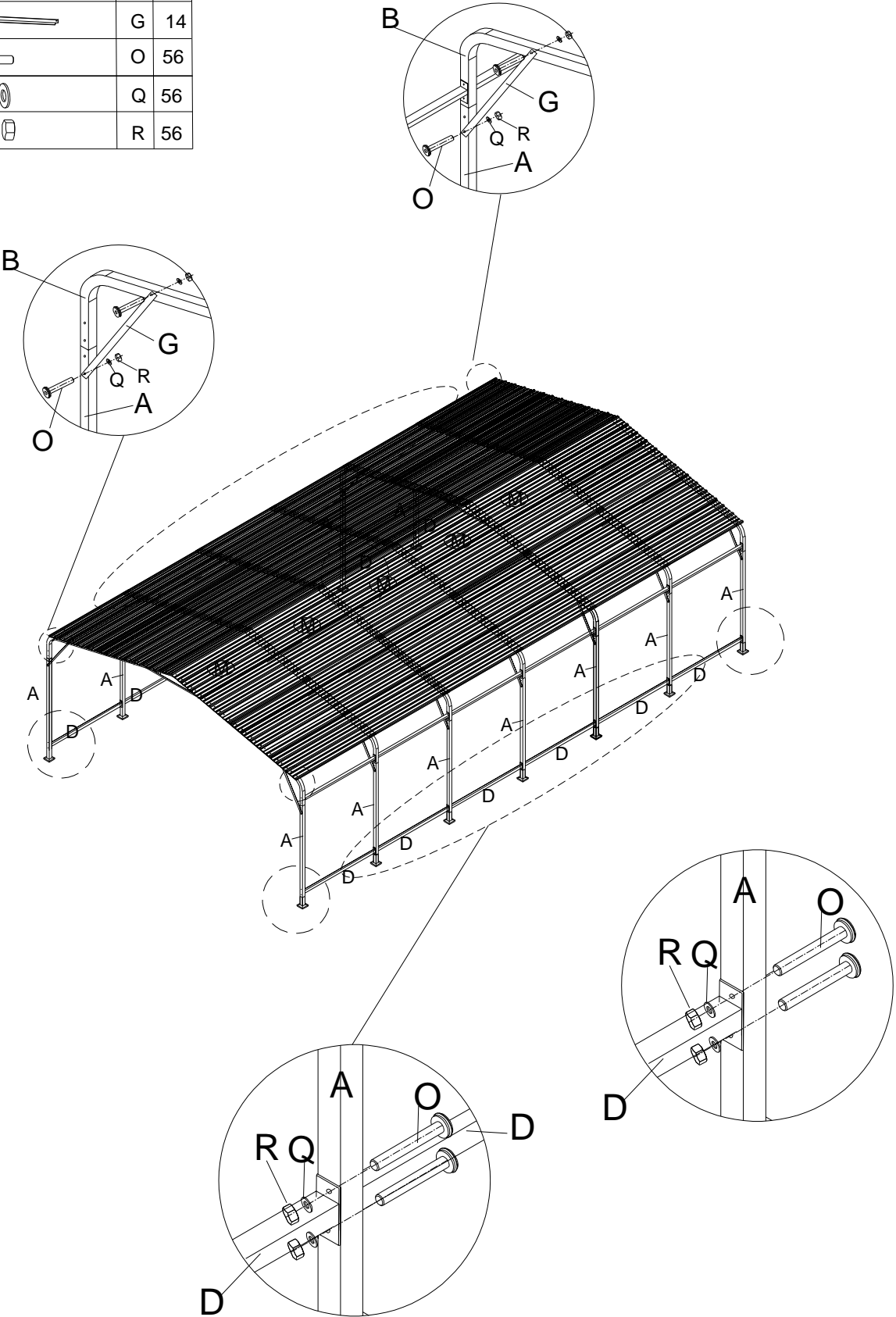

Step21

PART	Qty	NO
	D	12
	G	14
	O	56
	Q	56
	R	56



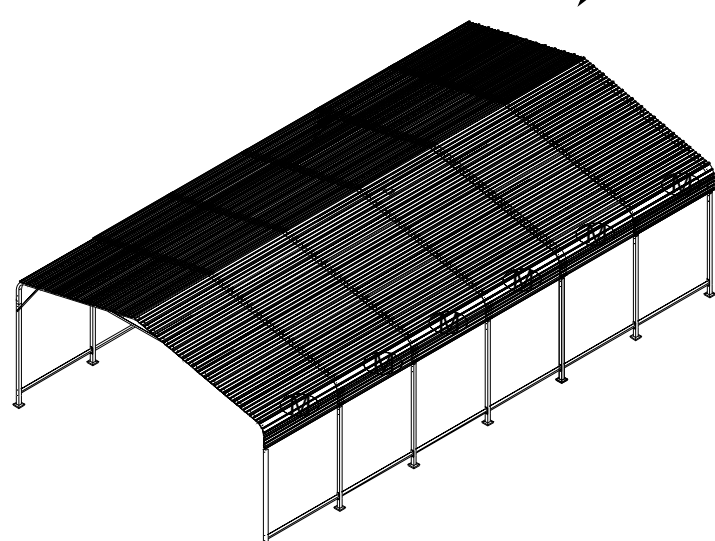
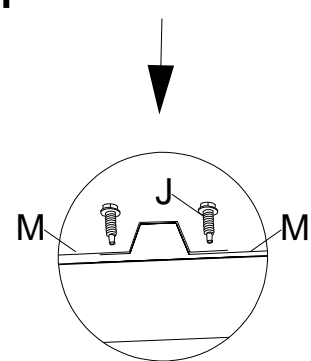
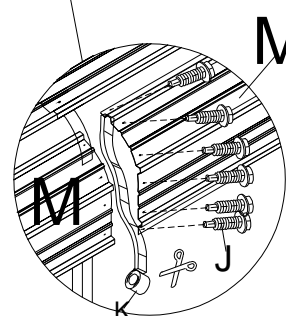
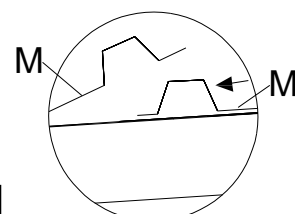
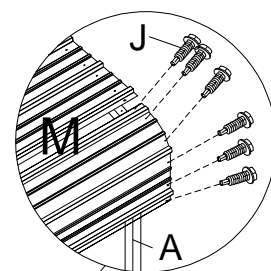
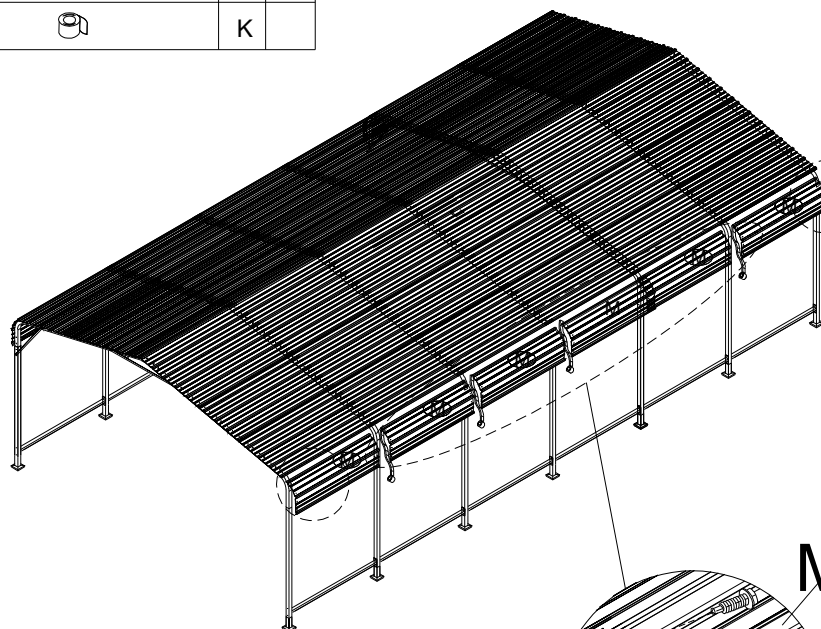

Step22

PART	Qty	NO
	M	6
	J	36
	K	



Step23

PART	Qty	NO
	M	6
	J	36
	K	

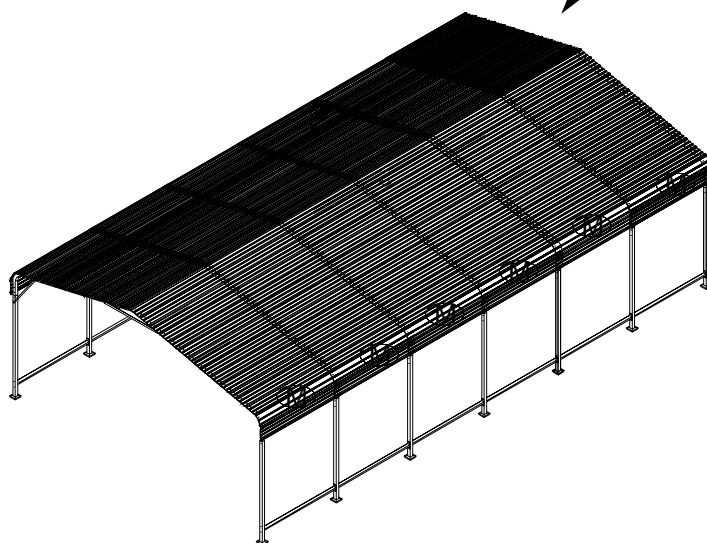
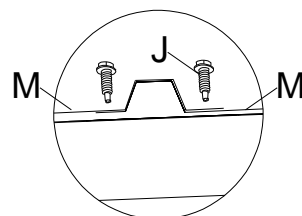
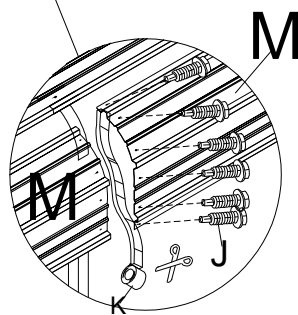
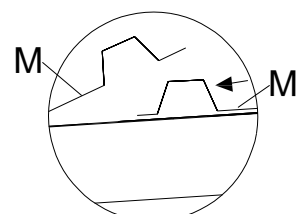
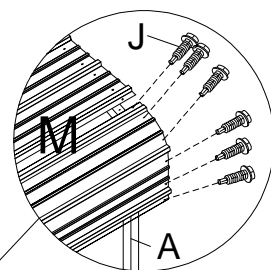
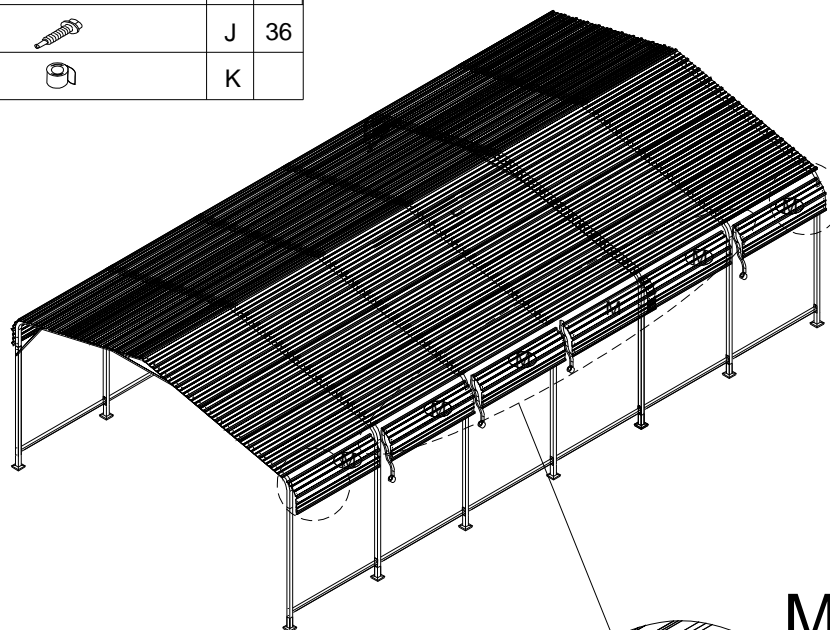

Step24

PART	Qty	NO
	L	1

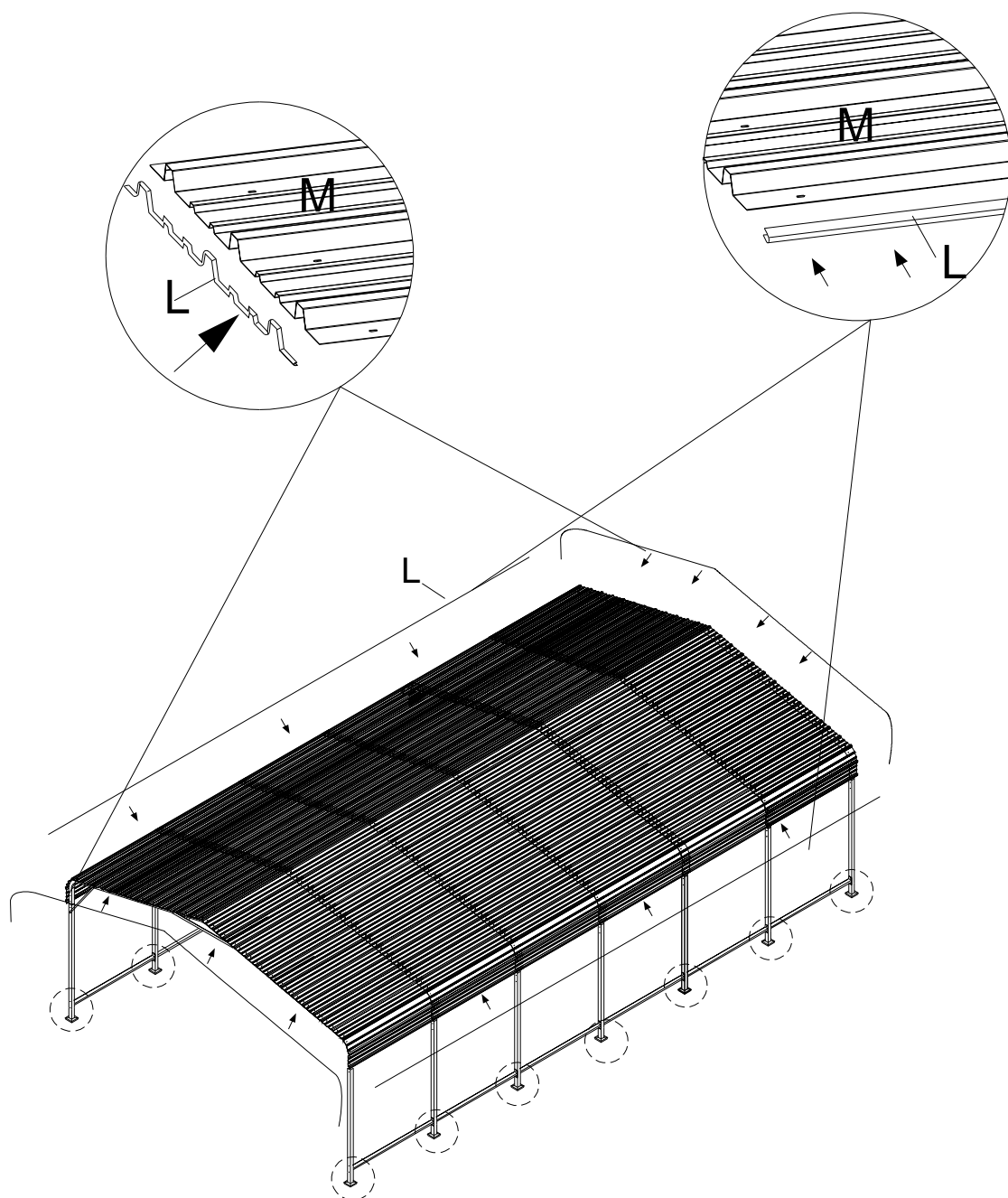

Step25

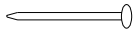
PART	Qty	NO
	S	28

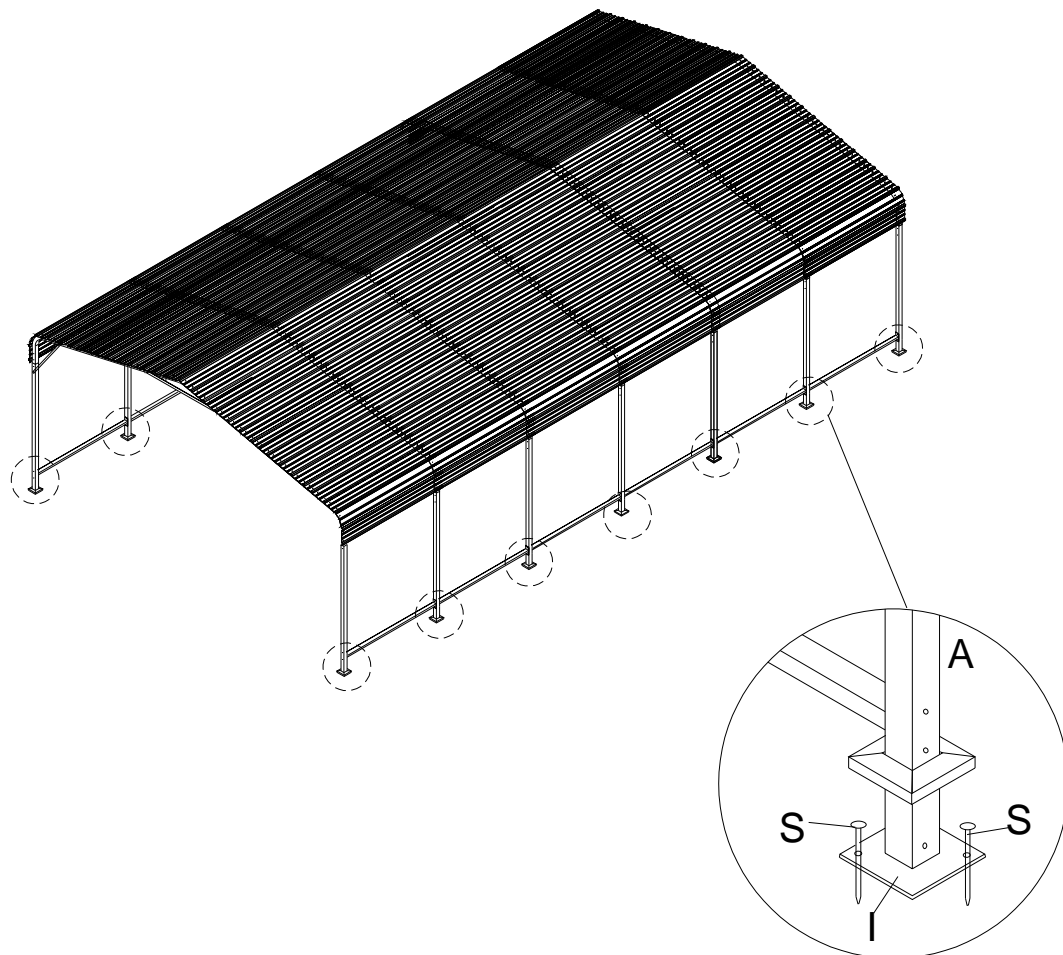

Step26

PART	Qty	NO
	T	28

