

**\*\* Do not tighten any bolts until all of them have been started !**

Step 1.

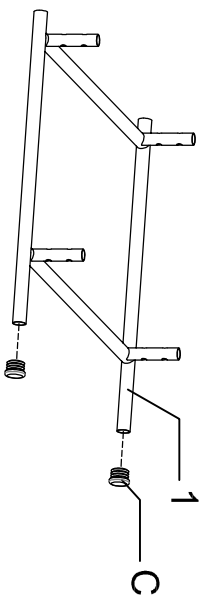

Step 3.

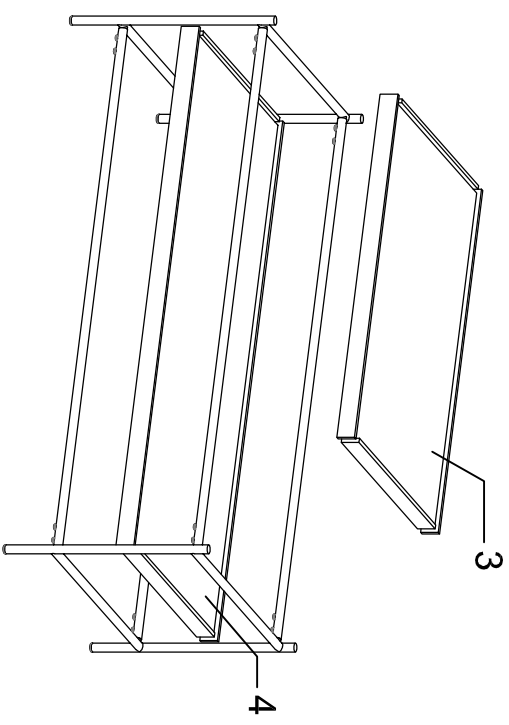

Step 2.

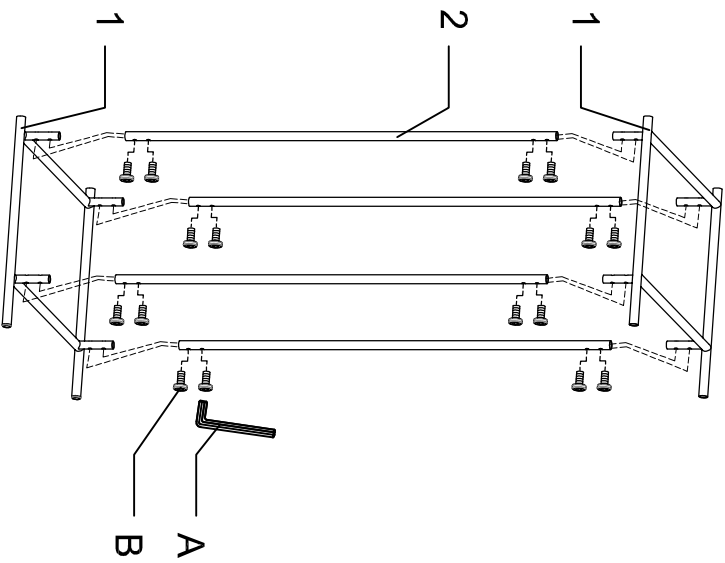



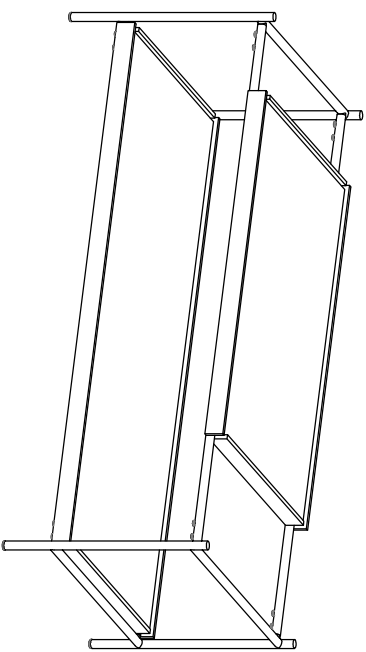



Step 4.

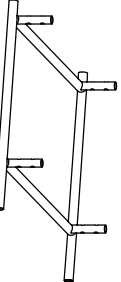

**ACCESSORY PACK**

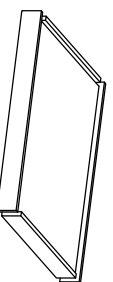
**COMPLETE HARDWARE**

A	 1/4"	B		C			
	1PC		16PCS		4PCS		
<b>COMPLETE HARDWARE</b>							
1	 2PCS	2	 4PCS	3	 1PC	4	 1PC