

ASSEMBLY INSTRUCTIONS

FULL

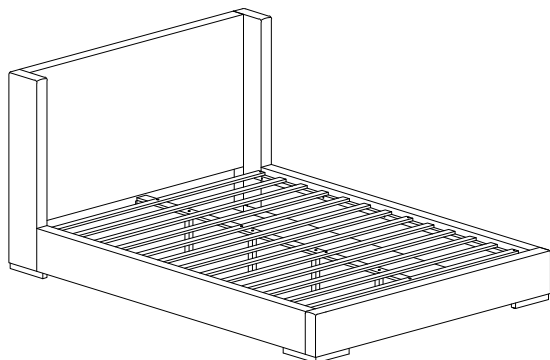

+ Do Not Use Power Tools



+ Suggested Adults

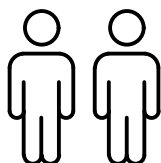

NOTE:

- 1 Read instructions cover to cover.
- 2 Save all packaging until assembly is completed.

1 IMPORTANT SAFETY INFORMATION

Do not assemble the product if any of the following parts arrived damaged:

1. Headboard Panel
2. Footboard Panel
3. Wing Left
4. Wing Right
5. Side Rail Left
6. Side Rail Right
7. Gold Leg
8. Silver Leg
9. Slats(13pcs)
10. Slat Support
11. Support Leg

2 IMPORTANT ASSEMBLY INFORMATION

Assembly Step Ensure the side rail bracket is fully hooked onto bolt loosely threaded with both washers on the OUTSIDE of the bracket first, then proceed to fully tightening all 4 corners.

+ Parts Included

- ① Headboard Panel (1 pc) ② Footboard Panel (1 pc)

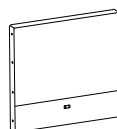

- ③ Wing Left (1 pc) ④ Wing Right (1 pc) ⑤ Side Rail Left (1 pc)

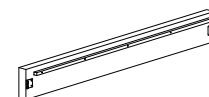
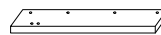
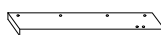

- ⑥ Side Rail Right (1 pc) ⑦ Gold Leg (4 pcs) ⑧ Silver Leg (4 pcs)

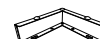
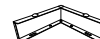
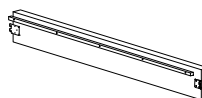

- ⑨ Slats(13pcs) (1 pc) ⑩ Slat Support (1 pc) ⑪ Support Leg (4 pcs)



+ Hardware Included

- A. Allen Key M4 (1 pc)

- B. Allen Key M5 (1 pc)



- C. JCBB Bolt M8 x 16mm (8 pcs)

- D. JCBC Bolt M6 x 15mm (16 pcs)



- E. JCBC Bolt M6 x 35mm (16 pcs)

- F. Spring Washer M6 (8 pcs)

- G. Flat Washer M6 (8 pcs)



- H. CBS Screw M4 x 16mm (4 pcs)

- I. CBS Screw M4 x 32mm (6 pcs)

- J. CBS Screw M4 x 50mm (2 pcs)



ASSEMBLY INSTRUCTIONS

FULL

